



New Product

Si4701BDY  
Vishay Siliconix

## Load Switch with Level-Shift

PRODUCT SUMMARY		
$V_{DS2}$ (V)	$r_{DS(on)}$ ( $\Omega$ )	$I_D$ (A)
30	0.015 @ $V_{GS2} = 10$ V	7.0
	0.021 @ $V_{GS2} = 4.5$ V	6.0



Product Is Completely Pb-free

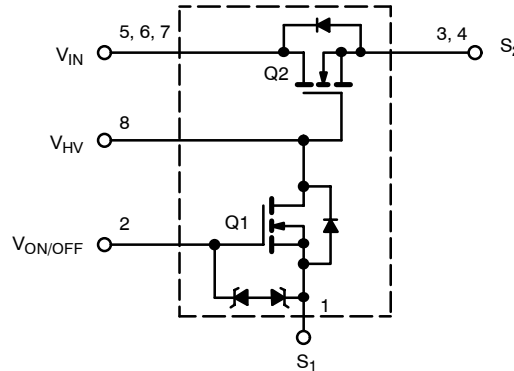
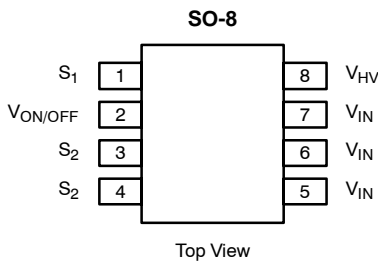

Ordering Information: Si4701BDY—E3  
Si4701BDY-T1—E3 (with Tape and Reel)

ABSOLUTE MAXIMUM RATINGS ( $T_A = 25^\circ\text{C}$ UNLESS OTHERWISE NOTED)			
Parameter	Symbol	Limit	Unit
Input Voltage	$V_{IN}$	30	V
Q2 Gate-Drive Voltage Referenced to S1 or S2	$V_{HV}$	20	
ON/OFF Voltage	$V_{ON/OFF}$	8	
Load Current	$I_L$	Continuous <sup>a</sup>	7.0
		Pulsed <sup>b</sup>	$\pm 30$
Continuous Intrinsic Diode Conduction <sup>a</sup>	$I_S$	-1.15	A
Maximum Power Dissipation <sup>a</sup>	$P_D$	1.25	W
Operating Junction and Storage Temperature Range	$T_J, T_{stg}$	-55 to 150	$^\circ\text{C}$
ESD Rating, MIL-STD-883D Human Body Model (100 pF, 1500 $\Omega$ )	ESD	3	kV

THERMAL RESISTANCE RATINGS				
Parameter	Symbol	Typical	Maximum	Unit
Maximum Junction-to-Ambient (t = steady state) <sup>a</sup>	$R_{thJA}$	80	100	$^\circ\text{C/W}$
Maximum Junction-to-Foot (Q2)	$R_{thJC}$	25	30	

SPECIFICATIONS ( $T_J = 25^\circ\text{C}$ UNLESS OTHERWISE NOTED)						
Parameter	Symbol	Test Condition	Min	Typ	Max	Unit
<b>OFF Characteristics</b>						
Reverse Leakage Current	$I_{FL}$	$V_{IN} = 30$ V, $V_{ON/OFF} = 0$ V, $V_{HV} = 0$ V			1	$\mu\text{A}$
Diode Forward Voltage	$V_{SD}$	$I_S = -1.15$ A		0.7	1	V
<b>ON Characteristics</b>						
On-Resistance (Q2)	$r_{DS(on)}$	$V_{ON/OFF} = 0$ V, $I_D = 7$ A, $V_{HV} = 10$ V, $V_{S2} = 0$ V		0.012	0.015	$\Omega$
		$V_{ON/OFF} = 0$ V, $I_D = 6$ A, $V_{HV} = 4.5$ V, $V_{S2} = 0$ V		0.017	0.021	
On-State (Q2) Drain-Current	$I_{D(on)}$	$V_{IN-OUT} \leq 0.1$ V, $V_{IN} = 5$ V, $V_{ON/OFF} = 0$ V, $V_{HV} = 10$ V	20			A

Notes

- a. Surface Mounted on FR4 Board.
- b. Pulse test: pulse width  $\leq 300$   $\mu\text{s}$ , duty cycle  $\leq 2\%$ .

Stresses beyond those listed under "Absolute Maximum Ratings" may cause permanent damage to the device. These are stress ratings only, and functional operation of the device at these or any other conditions beyond those indicated in the operational sections of the specifications is not implied. Exposure to absolute maximum rating conditions for extended periods may affect device reliability.



**TYPICAL CHARACTERISTICS (25 °C UNLESS NOTED)**

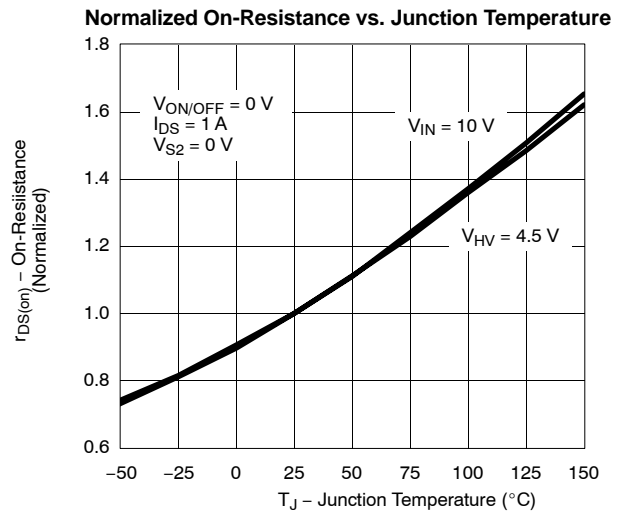
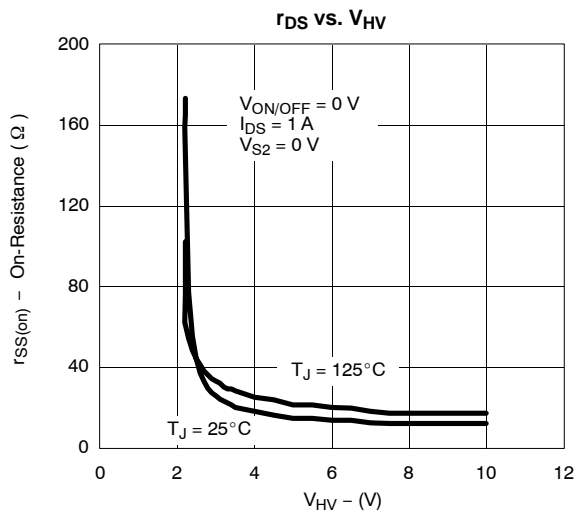
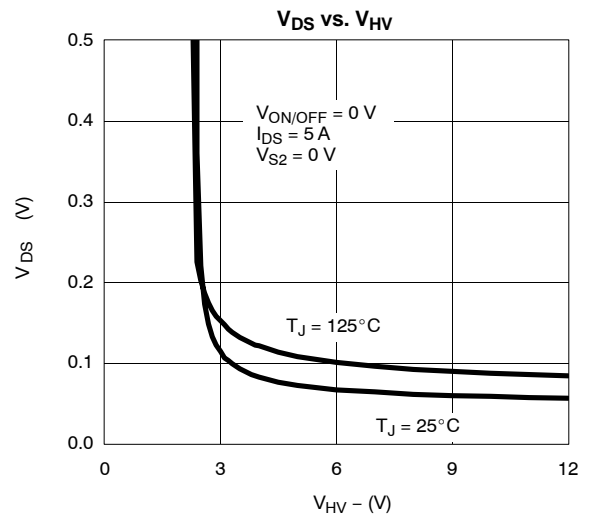
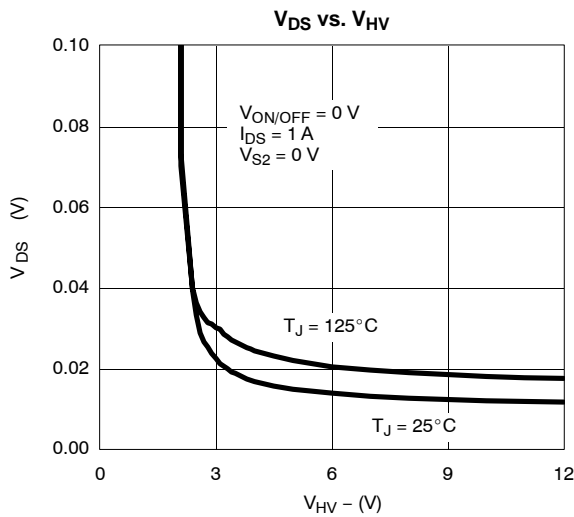
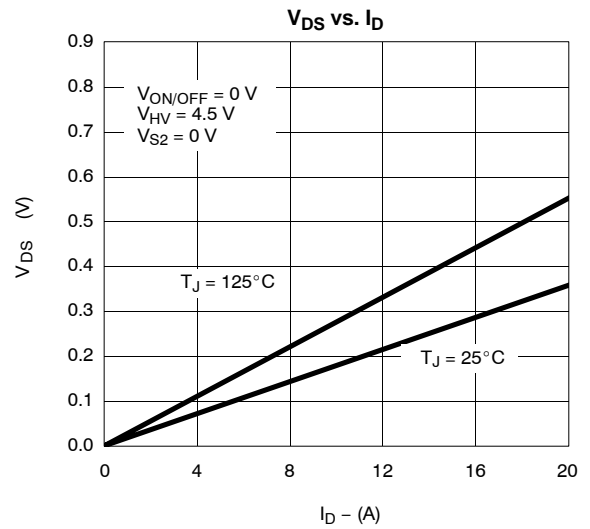
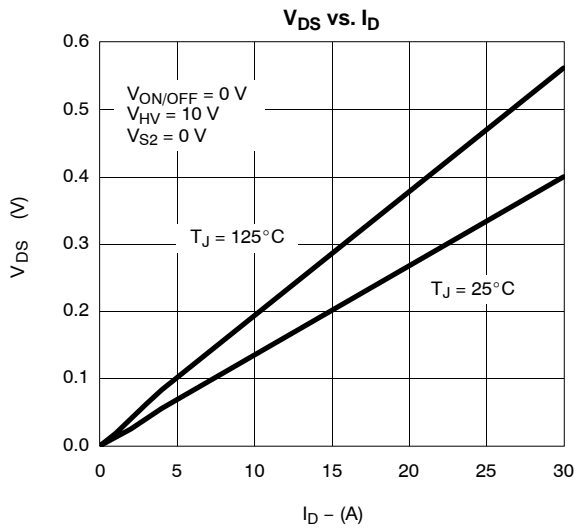

**TYPICAL CHARACTERISTICS (25°C UNLESS NOTED)**

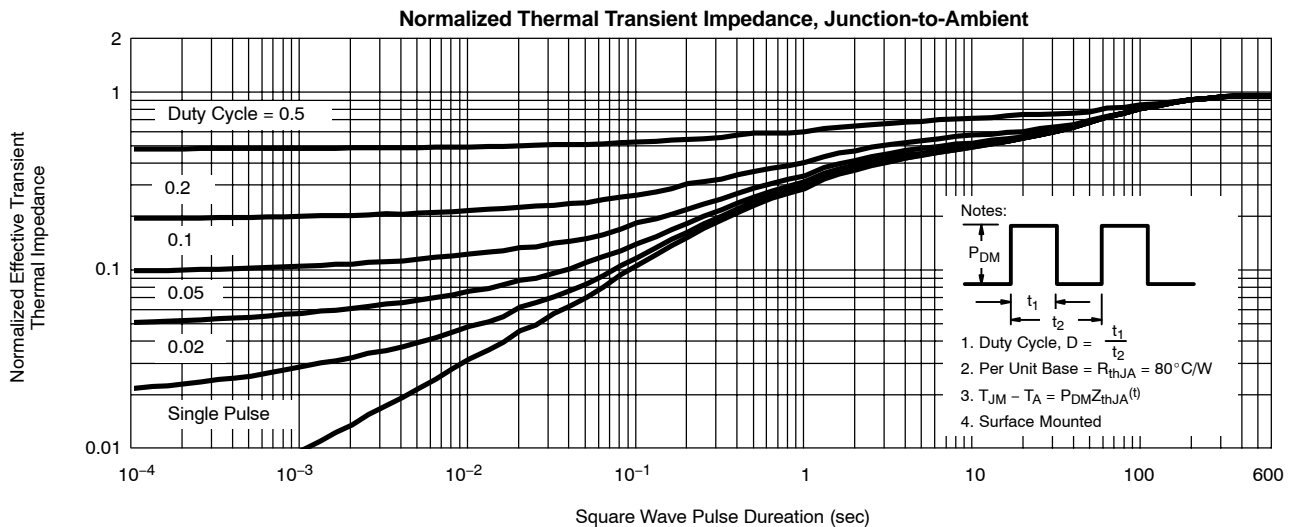
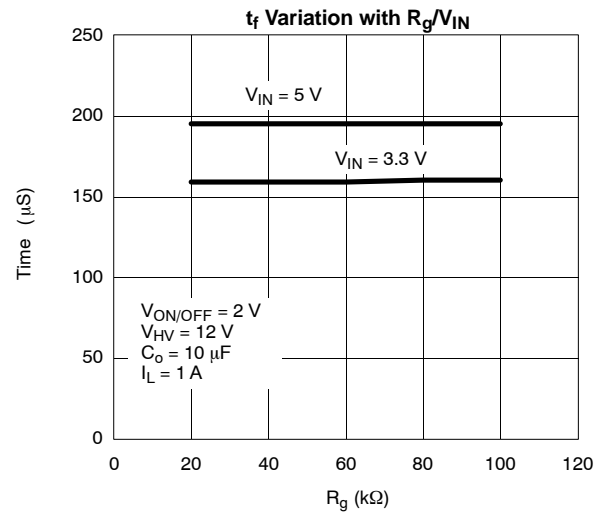
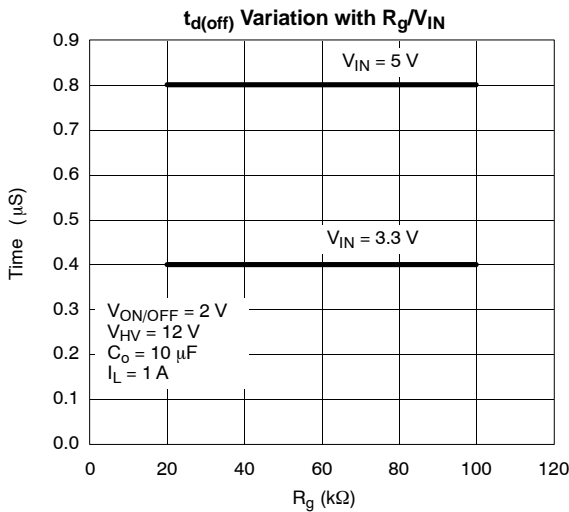
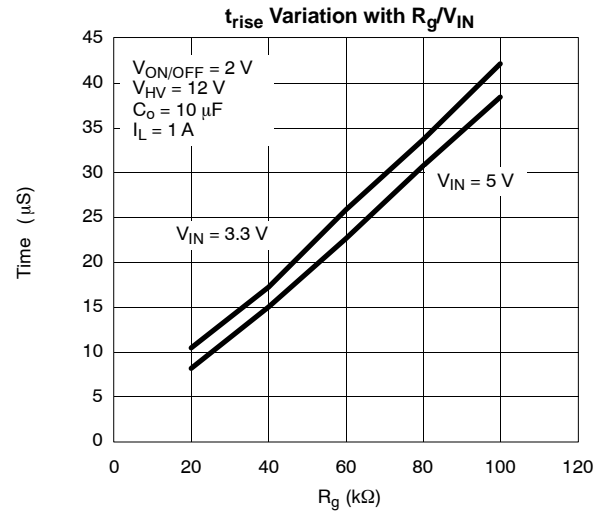
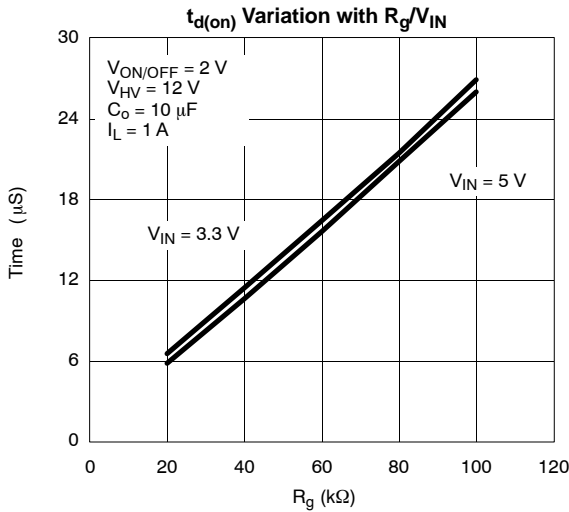

**TYPICAL CHARACTERISTICS (25 °C UNLESS NOTED)**

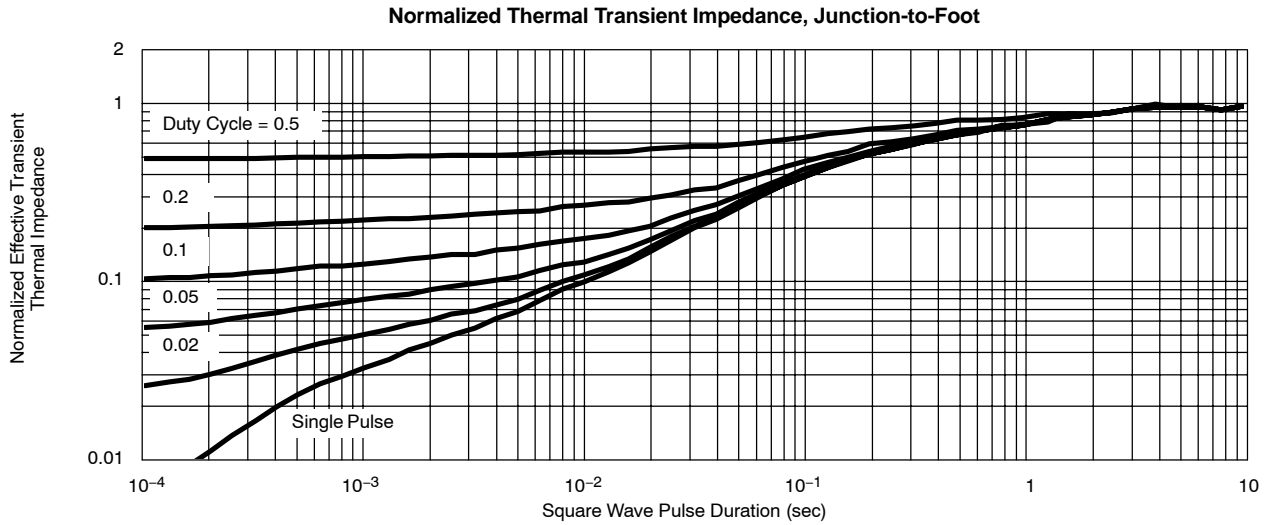

**TYPICAL APPLICATION CIRCUIT**

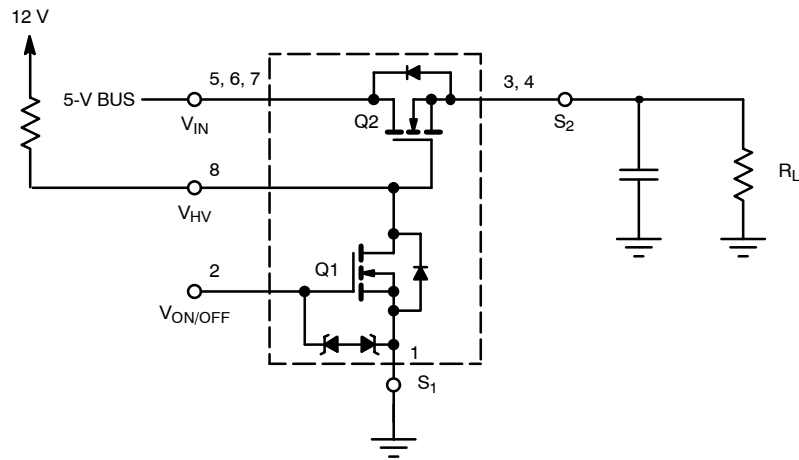

NOTE: Voltage difference between pull-up voltage, 12 V, and BUS voltage, 5 V, should be greater than 4.5 V.

Vishay Siliconix maintains worldwide manufacturing capability. Products may be manufactured at one of several qualified locations. Reliability data for Silicon Technology and Package Reliability represent a composite of all qualified locations. For related documents such as package/tape drawings, part marking, and reliability data, see <http://www.vishay.com/ppg?73250>.



## Notice

Specifications of the products displayed herein are subject to change without notice. Vishay Intertechnology, Inc., or anyone on its behalf, assumes no responsibility or liability for any errors or inaccuracies.

Information contained herein is intended to provide a product description only. No license, express or implied, by estoppel or otherwise, to any intellectual property rights is granted by this document. Except as provided in Vishay's terms and conditions of sale for such products, Vishay assumes no liability whatsoever, and disclaims any express or implied warranty, relating to sale and/or use of Vishay products including liability or warranties relating to fitness for a particular purpose, merchantability, or infringement of any patent, copyright, or other intellectual property right.

The products shown herein are not designed for use in medical, life-saving, or life-sustaining applications. Customers using or selling these products for use in such applications do so at their own risk and agree to fully indemnify Vishay for any damages resulting from such improper use or sale.