

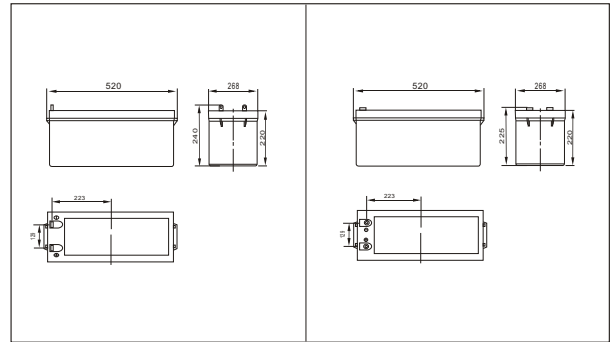

SW122300(12V230AH)



Outer dimensions (mm)



Specifications

Nominal Voltage		12V	
Rated capacity (10 hour rate)		230 Ah	
Dimensions	Total Height	T12	240 mm (9.44 inches)
		T19	225 mm (8.85 inches)
	Height	220 mm (8.66 inches)	
	Length	520 mm (20.5 inches)	
Width		268 mm (10.55 inches)	
Weight Approx		72.5 Kg (160.2 lbs)	

Terminal Type (mm)

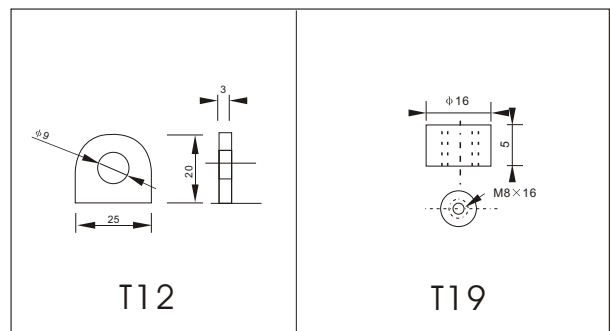

Characteristics

Capacity 25°C(77°F)	10 hour rate(23.0 A) 5 hour rate(36.8 A) 1 hour rate(138 A)	230 AH 184AH 138 AH
Internal Resistance	Full charged Battery at 25°C(77°F)	approx 2.5mΩ
Capacity affected by Temperature (10hour rate)	40°C(104°F) 25°C(77°F) 0°C(32°F) -15°C(5°F)	102% 100% 85% 65%
Self-Discharge at 25°C(77°F)	Capacity after 3 month storage Capacity after 6 month storage Capacity after 12 month storage	91% 82% 64%
Terminal	T12 T19	
Charge (constant Voltage)	Cycle	Initial Charging Current less than 92 A Voltage 14.10-14.40V
	Float	Voltage 13.50-13.80V

Discharge Curves 25°C(77°F)

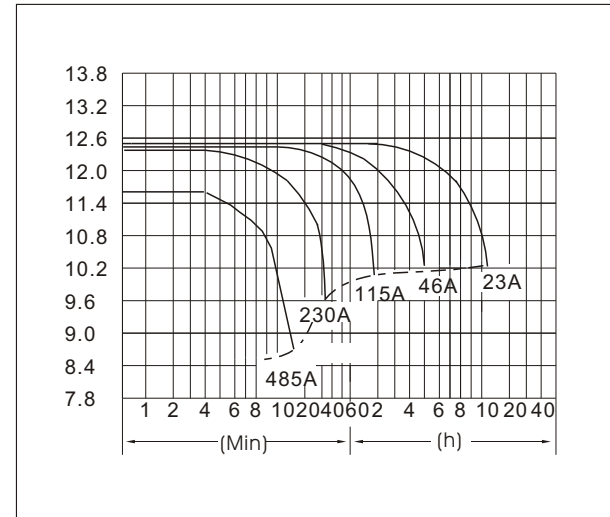

Constant Current(Amp) and Constant Power(Watt) Discharge Table at 25°C(77°F)

Time		5min	10min	15min	30min	1h	2h	3h	4h	5h	8h	10h	20h
9.60V	A	737	485	391	262.2	138.0	80.5	59.1	46.0	38.0	26.91	24.15	13.04
	W	7603	5183	4195	2819	1490	884	658	518	431	308	279	151.6
10.20V	A	713	438	368	250.7	129.7	76.8	57.5	44.9	37.3	26.22	23.69	12.65
	W	7620	4890	4123	2814	1467	885	666	522	434	307	278	148.4
10.50V	A	690	392	322	234.6	125.6	75.0	56.1	44.2	36.8	25.99	23.23	12.65
	W	7537	4456	3677	2700	1454	870	654	517	431	306	275	149.5
10.80V	A	665	369	299	216.2	121.4	73.1	54.7	43.5	35.9	25.30	23.00	12.42
	W	7463	4257	3450	2505	1414	857	645	513	424	300	273	147.9
11.10V	A	643	346	276	193.2	117.3	71.3	52.9	42.3	35.0	24.61	21.85	11.73
	W	7290	4006	3218	2260	1379	843	628	504	417	295	263.8	142.2