

FEATURES

- * Built-in bias resistors enable the configuration of an inverter circuit without connecting input resistors (see equivalent circuit).
- * Only the on/off conditions need to be set for operation, making device design easy.
- * The bias resistors consist of thin-film resistors with complete isolation to allow negative biasing of the input. They also have the advantage of almost completely eliminating parasitic effects.

●Equivalent circuit

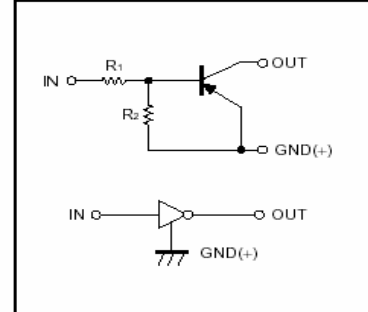

PIN CONNECTIONS AND MARKING

DTA143ZE



1.IN
2.GND
3.OUT

SOT-523

Abbreviated symbol: E13

DTA143ZUA

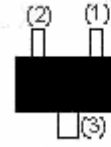

1.IN
2.GND
3.OUT

SOT-323

Abbreviated symbol: 113

DTA143ZKA

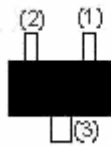

1.IN
2.GND
3.OUT

SOT-23-3L

Abbreviated symbol: E13

DTA143ZCA



1.IN
2.GND
3.OUT

SOT-23

Abbreviated symbol: E13

DTA143ZSA

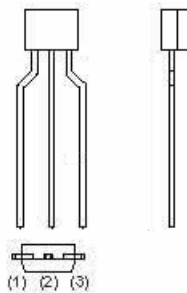

1.GND
2.OUT
3.IN

TO-92S

Absolute maximum ratings(Ta=25°C)

Parameter	Symbol	Limits (DTA143□)					Unit
		E	UA	KA	CA	SA	
Supply voltage	V_{CC}			-50			V
Input voltage	V_{IN}			-30~5			V
Output current	I_O			-100			mA
	$I_{C(MAX)}$			-100			
Power dissipation	P_d	150		200		300	mW
Junction temperature	T_j			150			°C
Storage temperature	T_{stg}			-55~150			°C

Electrical characteristics (Ta=25°C)

Parameter	Symbol	Min.	Typ	Max.	Unit	Conditions
Input voltage	$V_{I(off)}$			-0.5	V	$V_{CC}=-5V, I_O=-100\mu A$
	$V_{I(on)}$	-1.3				$V_O=-0.3V, I_O=-5mA$
Output voltage	$V_{O(on)}$			-0.3	V	$I_O/I_I=-5mA/-0.25mA$
Input current	I_I			-1.8	mA	$V_I=-5V$
Output current	$I_{O(off)}$			-0.5	μA	$V_{CC}=-50V, V_I=0$
DC current gain	G_I	80				$V_O=-5V, I_O=-10mA$
Input resistance	R_I	3.29	4.7	6.11	K Ω	
Resistance ratio	R_2/R_1	8	10	12		
Transition frequency	f_T		250		MHz	$V_O=-10V, I_O=-5mA, f=100MHz$

Typical Characteristics

●Electrical characteristic curves

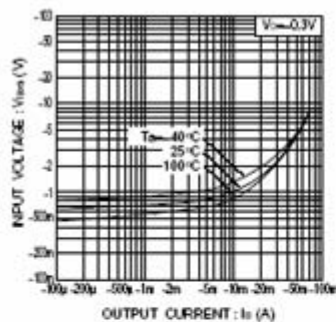

Fig.1 Input voltage vs. output current (ON characteristics)

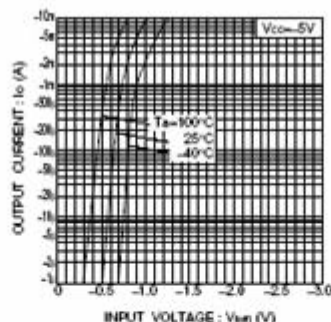

Fig.2 Output current vs. input voltage (OFF characteristics)

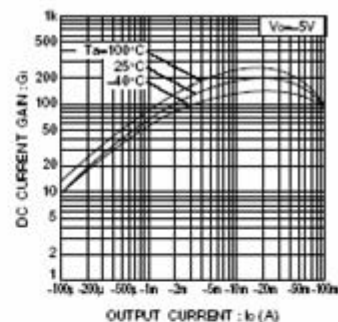

Fig.3 DC current gain vs. output current

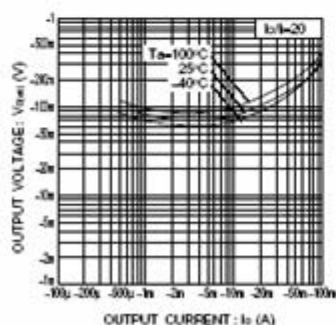

Fig.4 Output voltage vs. output current