

**N & P-Channel Enhancement Mode Power MOSFET**

# MTC2103BJ4

	N-CH	P-CH
$BV_{DSS}$	30V	-30V
$I_D$	8A	-6A
$R_{DS(on)(MAX)}$	21m $\Omega$	45m $\Omega$

**Features**

- Low Gate Charge
- Simple Drive Requirement
- 100% UIS test @  $V_D=15V$ ,  $L=0.1mH$ ,  $V_G=10V$ ,  $I_L=7.5A$ , Rated  $V_{DS}=30V$ , for N-CH
- 100% UIS test @  $V_D=15V$ ,  $L=0.1mH$ ,  $V_G=-10V$ ,  $I_L=-6A$ , Rated  $V_{DS}=-30V$ , for P-CH
- RoHS compliant & Halogen-free package

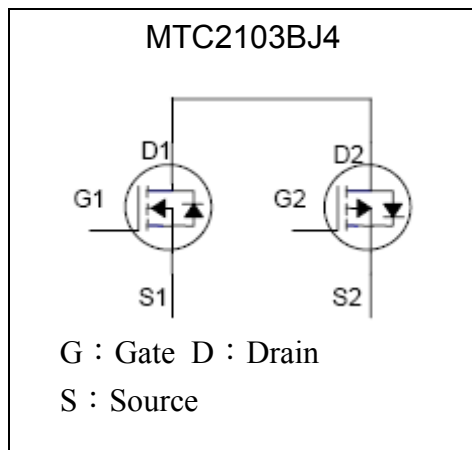
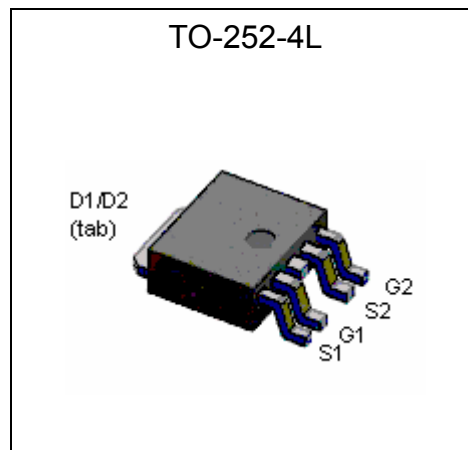
**Equivalent Circuit**

**Outline**

**Absolute Maximum Ratings** ( $T_c=25^\circ C$ , unless otherwise noted)

Parameter	Symbol	Limits		Unit
		N-channel	P-channel	
Drain-Source Voltage	$V_{DS}$	30	-30	V
Gate-Source Voltage	$V_{GS}$	$\pm 20$	$\pm 20$	
Continuous Drain Current @ $T_c=25^\circ C$	$I_D$	8	-6	A
Continuous Drain Current @ $T_c=100^\circ C$	$I_D$	6	-5	
Pulsed Drain Current *1	$I_{DM}$	32	-24	
Avalanche Current	$I_{AS}$	15	-15	
Avalanche Energy @ $L=0.1mH$ , $I_D=10A(-10A$ for P-ch), $R_G=25\Omega$	$E_{AS}$	5	5	mJ
Repetitive Avalanche Energy @ $L=0.05mH$ *2	$E_{AR}$	2.5	2.5	
Total Power Dissipation ( $T_c=25^\circ C$ )	$P_d$	25		W
Total Power Dissipation ( $T_c=100^\circ C$ )		18		
Operating Junction and Storage Temperature Range	$T_j, T_{stg}$	-55~+175		$^\circ C$

Note : \*1. Pulse width limited by maximum junction temperature

 \*2. Duty cycle  $\leq 1\%$



**Thermal Data**

Parameter	Symbol	Value	Unit
Thermal Resistance, Junction-to-case, max	$R_{th,j-c}$	6	$^{\circ}C/W$
Thermal Resistance, Junction-to-ambient, max * 1	$R_{th,j-a}$	90	$^{\circ}C/W$

Note : \*1 62.5 $^{\circ}C/W$  when mounted on a 1 in<sup>2</sup> pad of 2 oz copper.

**N-CH Characteristics (Tc=25 $^{\circ}C$ , unless otherwise specified)**

Symbol	Min.	Typ.	Max.	Unit	Test Conditions
<b>Static</b>					
$BV_{DSS}$	30	-	-	V	$V_{GS}=0, I_D=250\mu A$
$V_{GS(th)}$	1	1.5	3	V	$V_{DS}=V_{GS}, I_D=250\mu A$
$G_{FS}$ *1	-	16	-	S	$V_{DS}=5V, I_D=8A$
$I_{GSS}$	-	-	$\pm 100$	nA	$V_{GS}=\pm 20, V_{DS}=0$
$I_{DSS}$	-	-	1	$\mu A$	$V_{DS}=24V, V_{GS}=0$
	-	-	25	$\mu A$	$V_{DS}=20V, V_{GS}=0, T_j=125^{\circ}C$
$I_{D(ON)}$ *1	8	-	-	A	$V_{DS}=10V, V_{GS}=10V$
$R_{DS(ON)}$ *1	-	18	21	m $\Omega$	$V_{GS}=10V, I_D=8A$
	-	34	42	m $\Omega$	$V_{GS}=4.5V, I_D=6A$
<b>Dynamic</b>					
$Q_g(V_{GS}=10V)$ *1	-	11	-	nC	$I_D=8A, V_{DS}=15V, V_{GS}=10V$
$Q_g(V_{GS}=4.5V)$ *1	-	6	-		
$Q_{gs}$ *1	-	1.2	-		
$Q_{gd}$ *1	-	3.3	-	ns	$V_{DS}=15V, I_D=1A, V_{GS}=10V, R_G=6\Omega$
$t_{d(ON)}$ *1	-	11	-		
$t_r$ *1	-	16	-		
$t_{d(OFF)}$ *1	-	36	-		
$t_f$ *1	-	20	-	pF	$V_{GS}=0V, V_{DS}=15V, f=1MHz$
$C_{iss}$	-	1115	-		
$C_{oss}$	-	116	-		
$C_{rss}$	-	82	-		
<b>Source-Drain Diode</b>					
$I_S$ *1	-	-	2.3	A	
$I_{SM}$ *2	-	-	9.2		
$V_{SD}$ *1	-	-	1.2	V	$I_F=I_S, V_{GS}=0V$
$t_{rr}$ *1	-	50	-	ns	$I_F=I_S, V_{GS}=0, dI_F/dt=100A/\mu s$
$Q_{rr}$ *1	-	2	-	nC	

Note : \*1.Pulse Test : Pulse Width  $\leq 300\mu s$ , Duty Cycle  $\leq 2\%$

\*2.Pulse width limited by maximum junction temperature.



**P-CH Characteristics (Tc=25°C, unless otherwise specified)**

Symbol	Min.	Typ.	Max.	Unit	Test Conditions
<b>Static</b>					
BV <sub>DSS</sub>	-30	-	-	V	V <sub>GS</sub> =0, I <sub>D</sub> =-250μA
V <sub>GS(th)</sub>	-1	-1.5	-3	V	V <sub>DS</sub> =V <sub>GS</sub> , I <sub>D</sub> =-250μA
G <sub>FS</sub> *1	-	16	-	S	V <sub>DS</sub> =-5V, I <sub>D</sub> =-6A
I <sub>GSS</sub>	-	-	±100	nA	V <sub>GS</sub> =±20, V <sub>DS</sub> =0
I <sub>DSS</sub>	-	-	-1	μA	V <sub>DS</sub> =-24V, V <sub>GS</sub> =0
	-	-	-25	μA	V <sub>DS</sub> =-20V, V <sub>GS</sub> =0, T <sub>j</sub> =125°C
I <sub>D(ON)</sub> *1	-6	-	-	A	V <sub>DS</sub> =-5V, V <sub>GS</sub> =-10V
R <sub>DS(ON)</sub> *1	-	36	45	mΩ	V <sub>GS</sub> =-10V, I <sub>D</sub> =-6A
	-	60	76	mΩ	V <sub>GS</sub> =-4.5V, I <sub>D</sub> =-5A
<b>Dynamic</b>					
Q <sub>g</sub> (V <sub>GS</sub> =-10V)*1	-	10	-	nC	I <sub>D</sub> =-6A, V <sub>DS</sub> =-15V, V <sub>GS</sub> =-10V
Q <sub>g</sub> (V <sub>GS</sub> =-4.5V)*1	-	7.2	-		
Q <sub>gs</sub> *1	-	2.2	-		
Q <sub>gd</sub> *1	-	2	-		
t <sub>d(ON)</sub> *1	-	5.5	-	ns	V <sub>DS</sub> =-15V, I <sub>D</sub> =-1A, V <sub>GS</sub> =-10V, R <sub>G</sub> =6Ω
t <sub>r</sub> *1	-	10	-		
t <sub>d(OFF)</sub> *1	-	28	-		
t <sub>f</sub> *1	-	15	-	pF	V <sub>GS</sub> =0V, V <sub>DS</sub> =-15V, f=1MHz
C <sub>iss</sub>	-	1320	-		
C <sub>oss</sub>	-	500	-		
C <sub>rss</sub>	-	460	-		
<b>Source-Drain Diode</b>					
I <sub>s</sub> *1	-	-	-2.3	A	
I <sub>SM</sub> *2	-	-	-9.2		
V <sub>SD</sub> *1	-	-	-1.2	V	I <sub>F</sub> =I <sub>S</sub> , V <sub>GS</sub> =0V
t <sub>rr</sub> *1	-	55	-	ns	I <sub>F</sub> =I <sub>S</sub> , V <sub>GS</sub> =0, dI <sub>F</sub> /dt=100A/μs
Q <sub>rr</sub> *1	-	2.2	-	nC	

Note : \*1.Pulse Test : Pulse Width ≤300μs, Duty Cycle≤2%  
 \*2.Pulse width limited by maximum junction temperature.

**Ordering Information**

Device	Package	Shipping	Marking
MTC2103BJ4	TO-252 (RoHS compliant & Halogen-free package)	2500 pcs / Tape & Reel	2103



## Characteristic Curves

### N-Channel

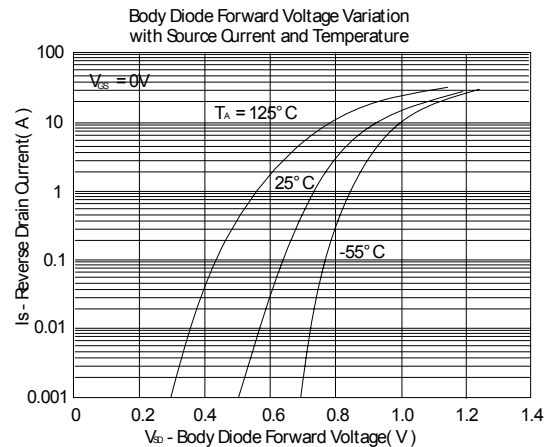
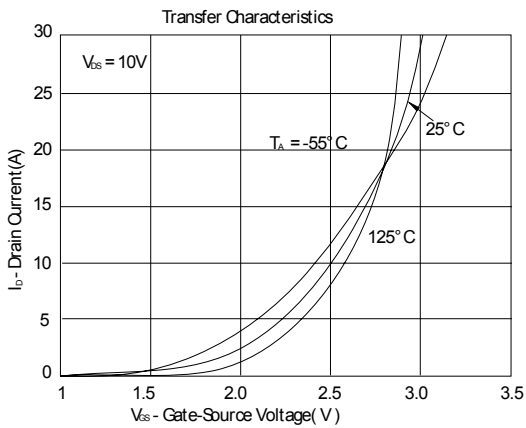
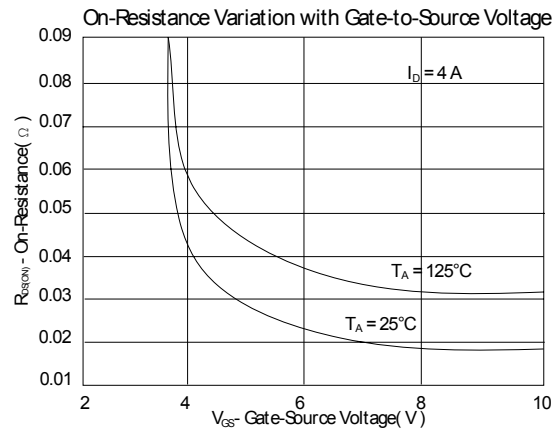
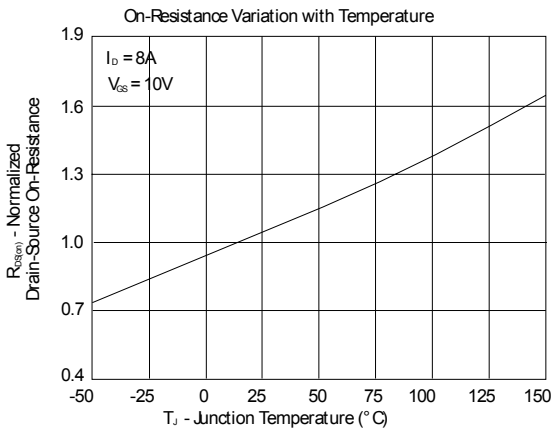
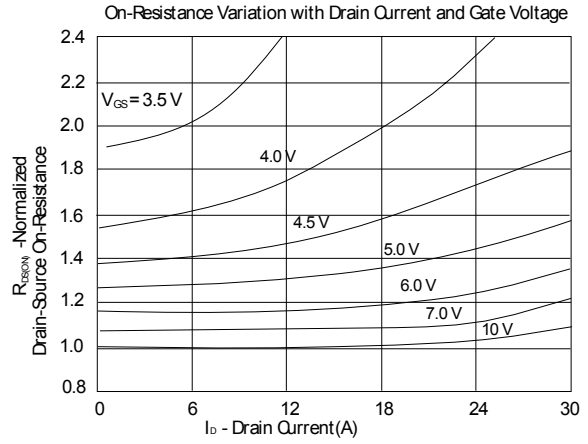
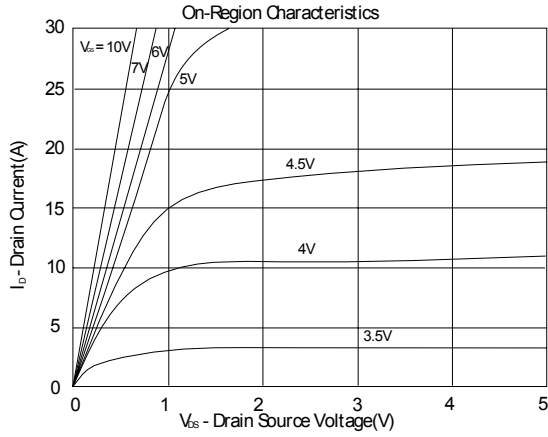



**Characteristic Curves(Cont.)**

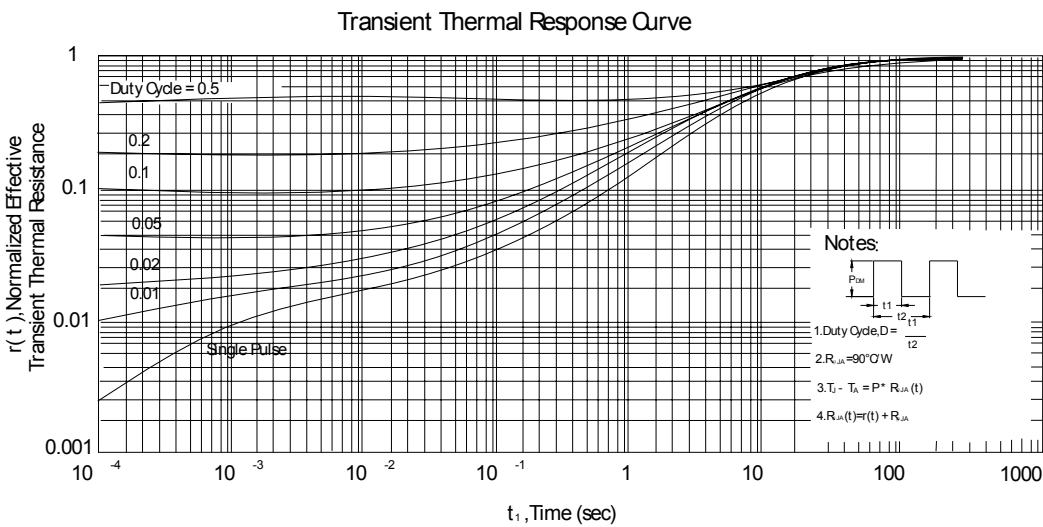
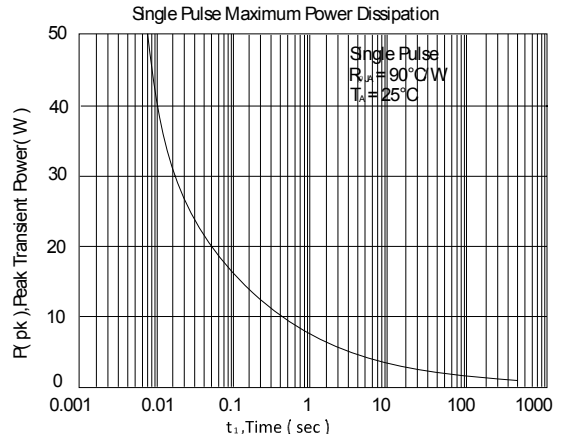
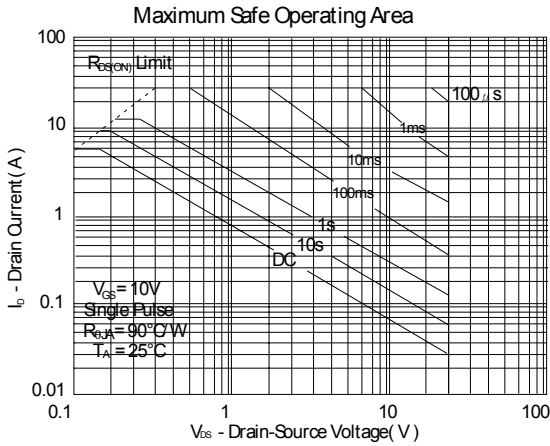
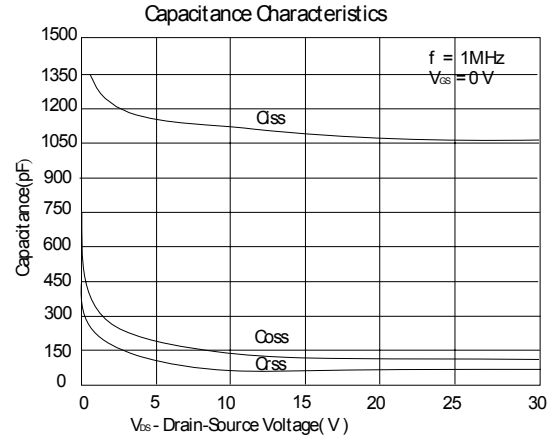
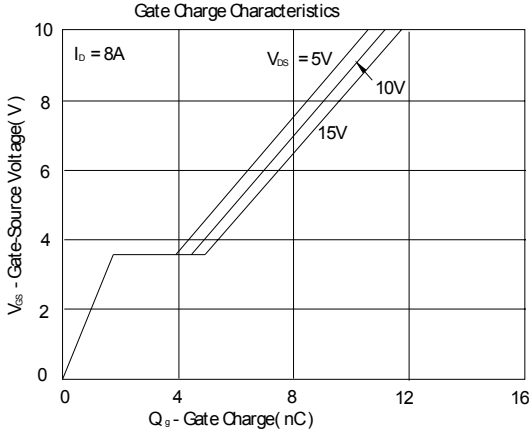



### Characteristic Curves(Cont.)

#### P-Channel

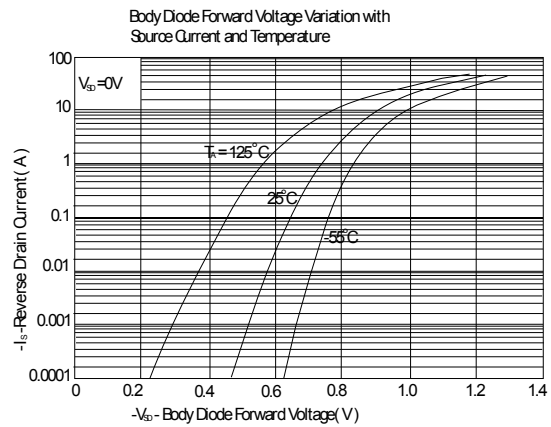
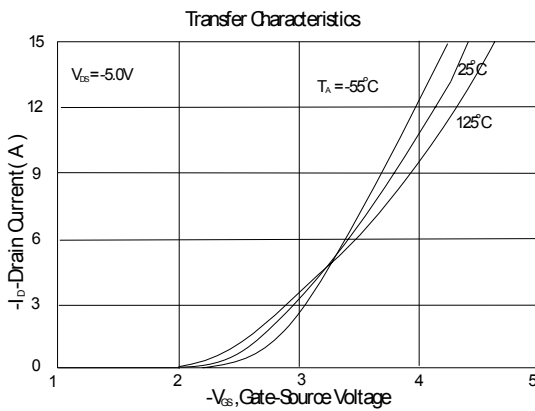
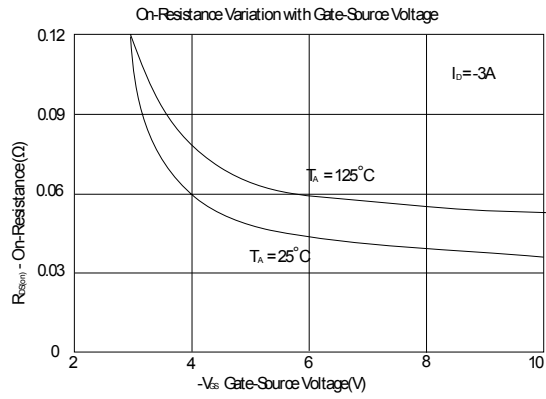
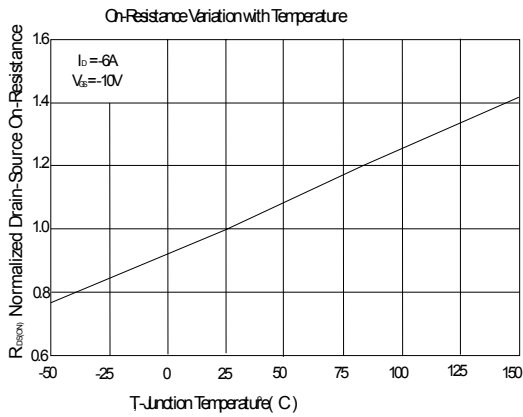
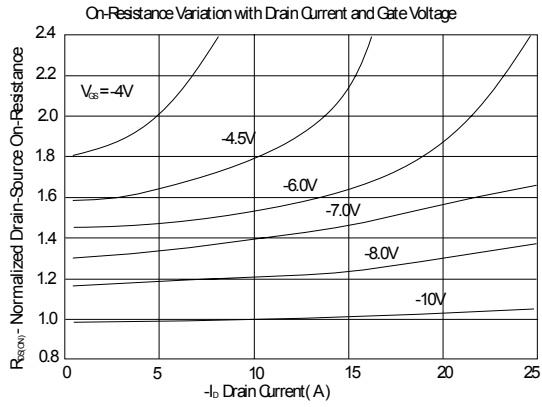
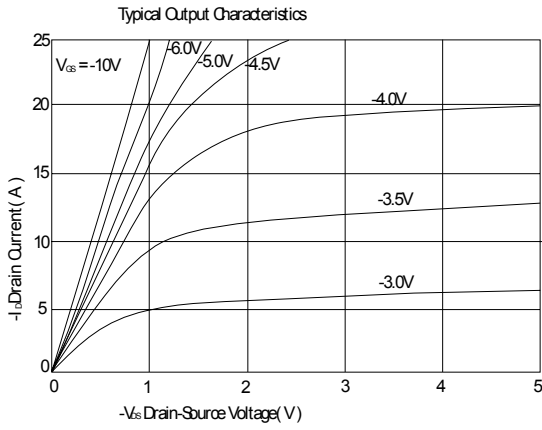



**Characteristic Curves(Cont.)**

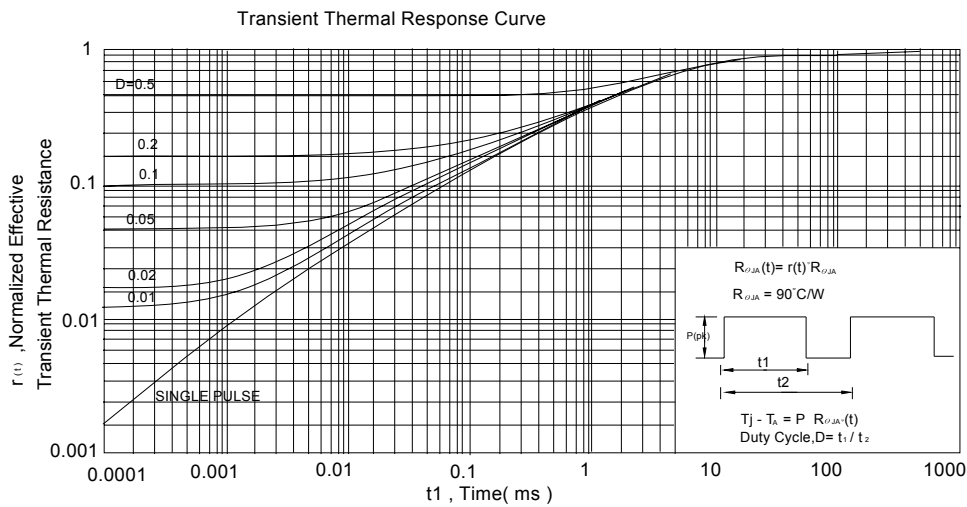
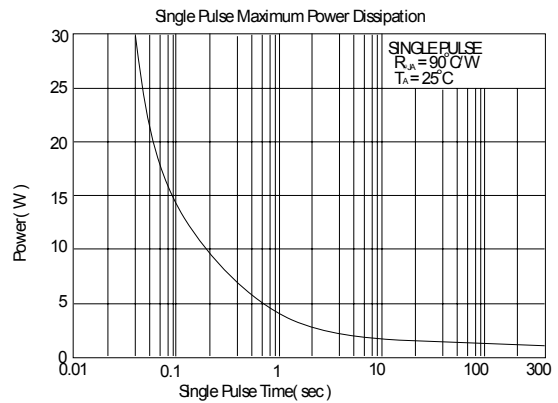
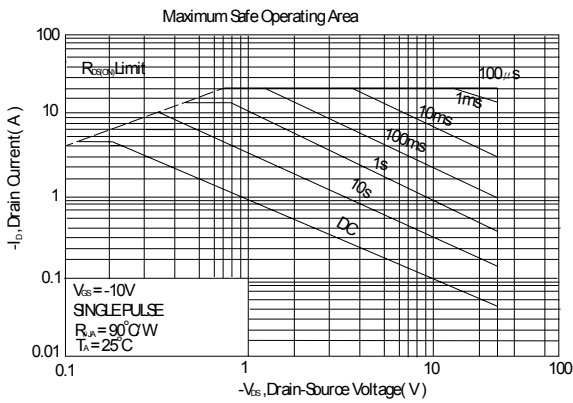
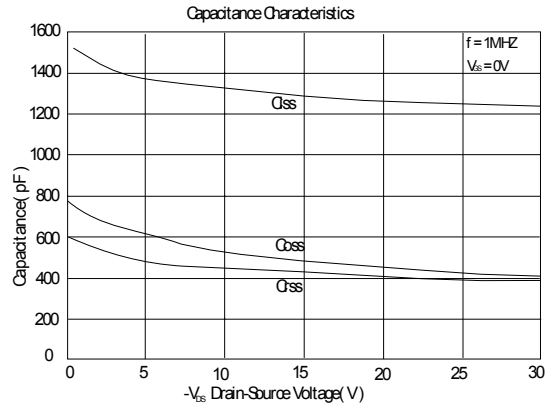
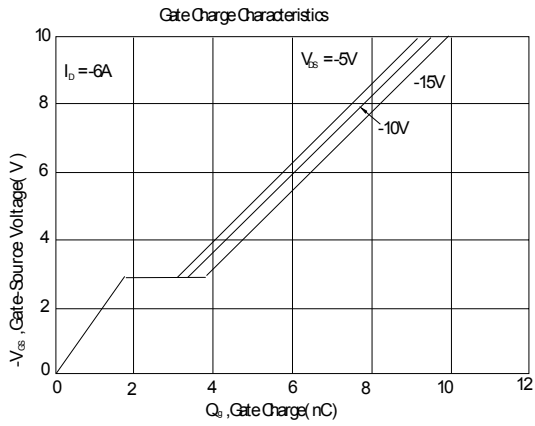

### Reel Dimension

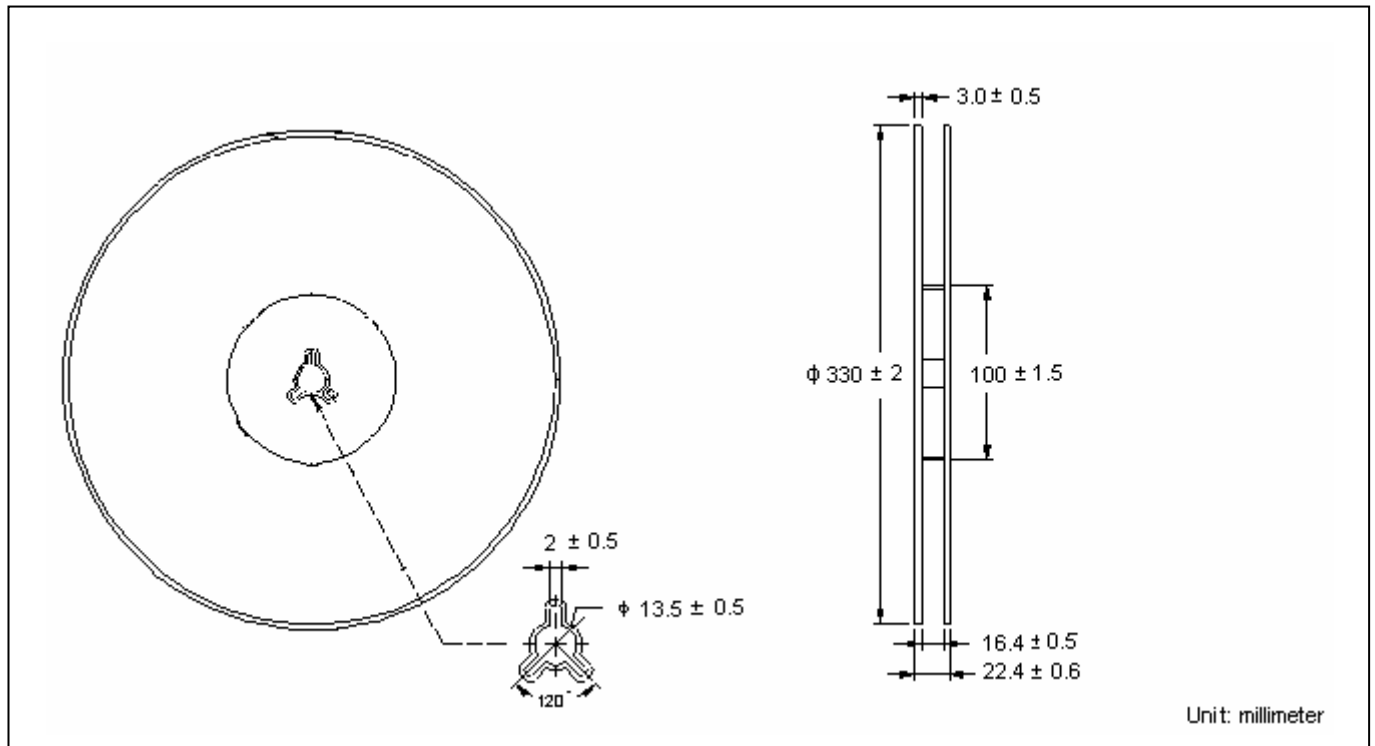

### Carrier Tape Dimension

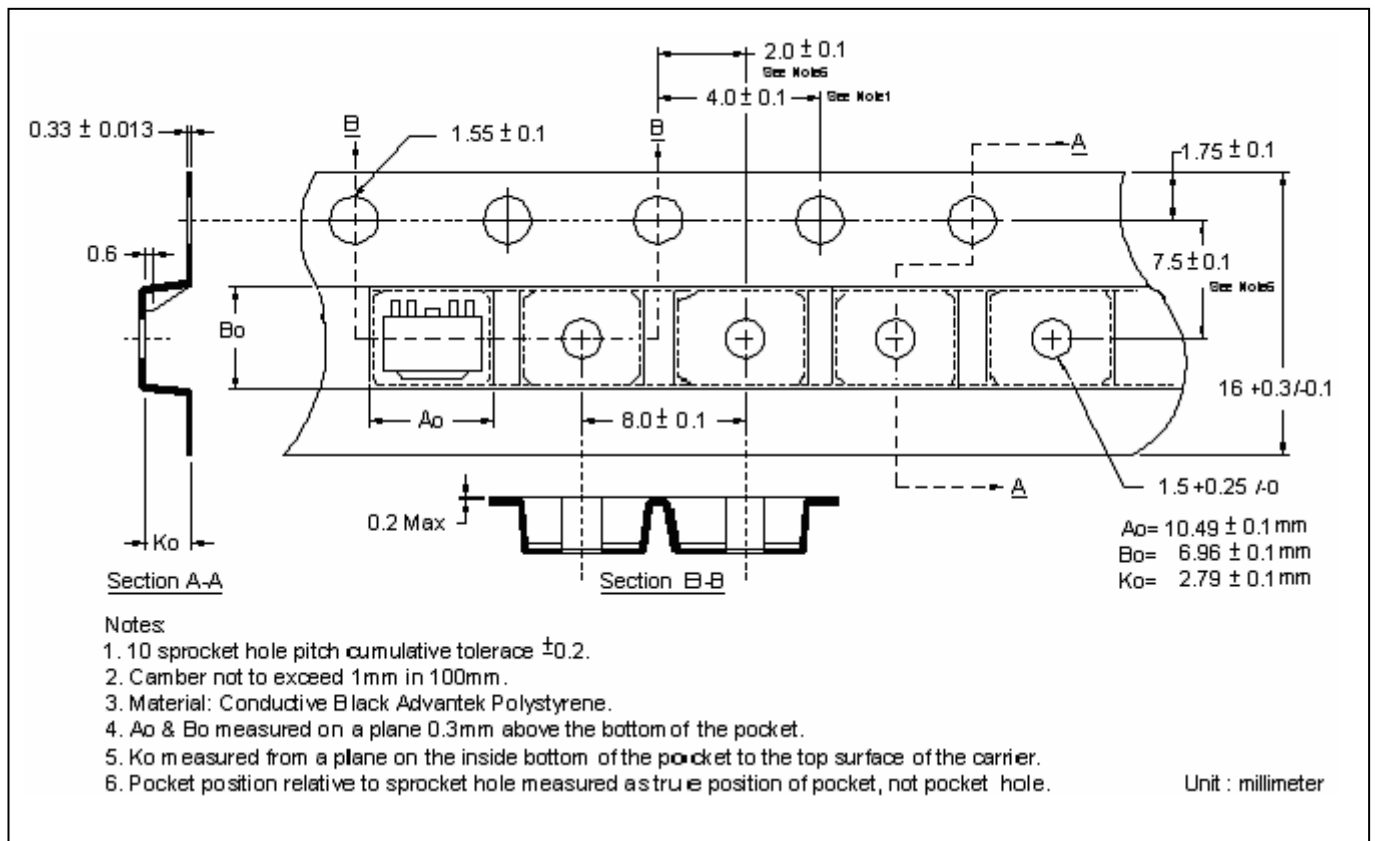



**Recommended soldering footprint**

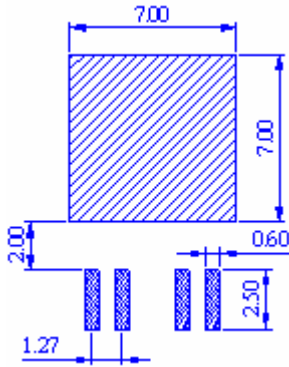

Unit : mm

**Recommended wave soldering condition**

Product	Peak Temperature	Soldering Time
Pb-free devices	260 +0/-5 °C	5 +1/-1 seconds

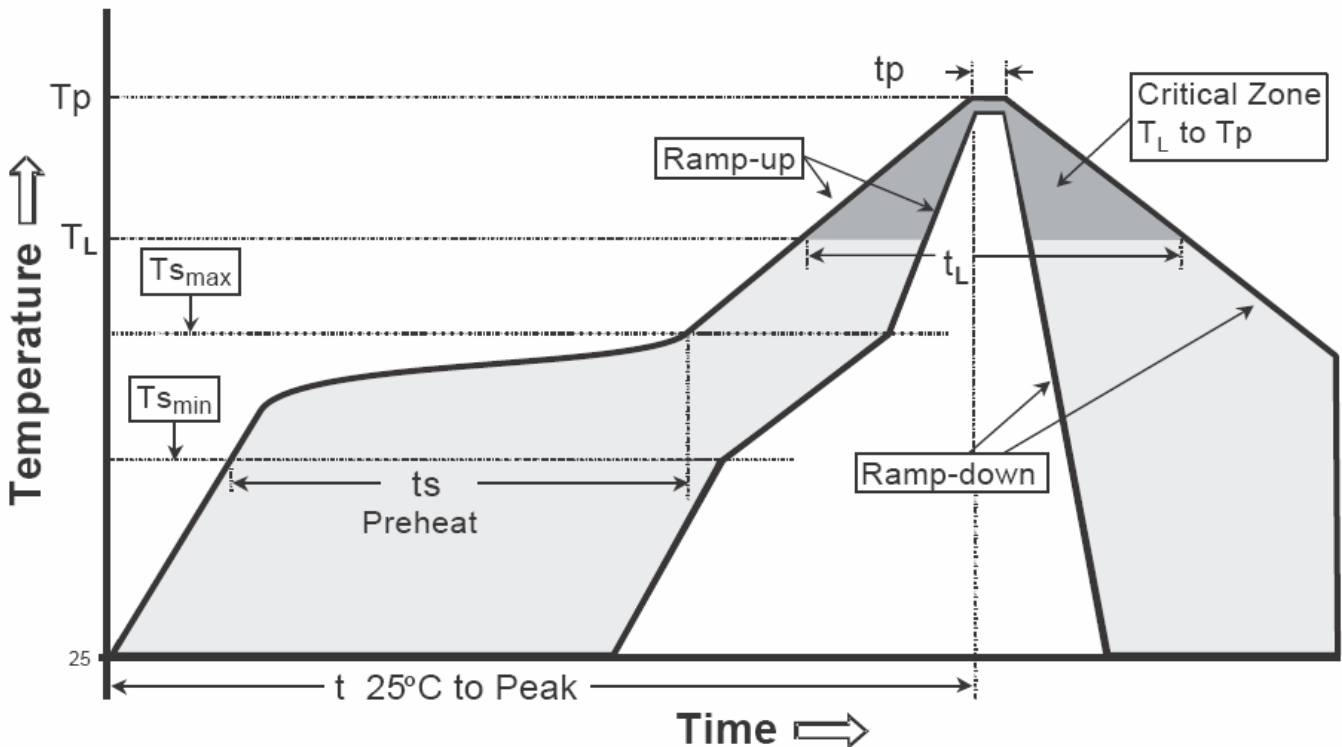
**Recommended temperature profile for IR reflow**

Profile feature	Sn-Pb eutectic Assembly	Pb-free Assembly
Average ramp-up rate (T <sub>smax</sub> to T <sub>p</sub> )	3°C/second max.	3°C/second max.
Preheat		
-Temperature Min(T <sub>s min</sub> )	100°C	150°C
-Temperature Max(T <sub>s max</sub> )	150°C	200°C
-Time(t <sub>s min</sub> to t <sub>s max</sub> )	60-120 seconds	60-180 seconds
Time maintained above:		
-Temperature (T <sub>L</sub> )	183°C	217°C
- Time (t <sub>L</sub> )	60-150 seconds	60-150 seconds
Peak Temperature(T <sub>P</sub> )	240 +0/-5 °C	260 +0/-5 °C
Time within 5°C of actual peak temperature(tp)	10-30 seconds	20-40 seconds
Ramp down rate	6°C/second max.	6°C/second max.
Time 25 °C to peak temperature	6 minutes max.	8 minutes max.

Note : All temperatures refer to topside of the package, measured on the package body surface.

**TO-252 Dimension**

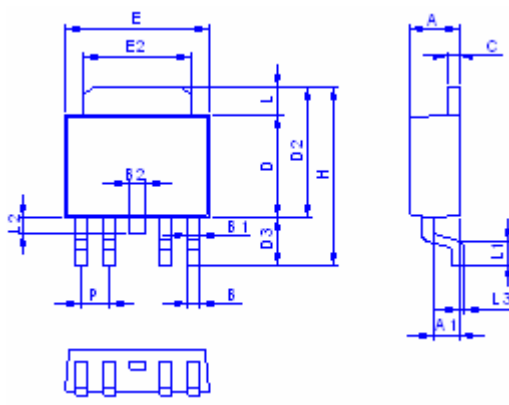

**Marking:**

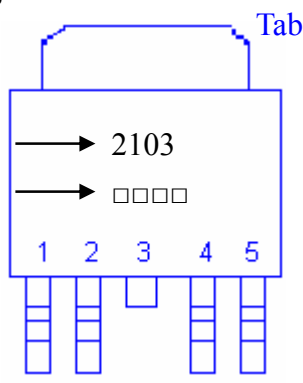

Device Name → 2103  
 Date code → □□□□

1 2 3 4 5

Tab

Style: Pin 1.Soure 1 2.Gate 1 3.&Tab  
 Drain 1& Drain 2 4. Source 2 5. Gate 2

4-Lead TO-252 Plastic Surface Mount Package  
 CYStek Package Code: J4

DIM	Inches		Millimeters		DIM	Inches		Millimeters	
	Min.	Max.	Min.	Max.		Min.	Max.	Min.	Max.
A	0.0826	0.0984	2.10	2.50	E	0.2480	0.2638	6.30	6.70
A1	0.0433	0.0512	1.10	1.30	E2	0.1890	0.2146	4.80	5.45
B	0.0118	0.0276	0.30	0.70	H	0.3622	0.3996	9.20	10.15
B1	0.0217	0.0295	0.55	0.75	L	0.0512	0.0669	1.30	1.70
B2	0.0157	0.0315	0.40	0.80	L1	0.0354	0.0590	0.90	1.50
C	0.157	0.0236	0.40	0.60	L2	0.0197	0.0433	0.50	1.10
D	0.2087	0.2244	5.30	5.70	L3	0.0000	0.0118	0.00	0.30
D2	0.2638	0.2874	6.70	7.30	P	0.0461	0.0539	1.17	1.37
D3	0.0866	0.1181	2.20	3.00					

**Notes:** 1.Controlling dimension: millimeters.  
 2.Maximum lead thickness includes lead finish thickness, and minimum lead thickness is the minimum thickness of base material.  
 3.If there is any question with packing specification or packing method, please contact your local CYStek sales office.

**Material:**

- Lead : KFC; Pure tin plated
- Mold Compound: Epoxy resin family, flammability solid burning class: UL94V-0

**Important Notice:**

- All rights are reserved. Reproduction in whole or in part is prohibited without the prior written approval of CYStek.
- CYStek reserves the right to make changes to its products without notice.
- CYStek **semiconductor products are not warranted to be suitable for use in Life-Support Applications, or systems.**
- CYStek assumes no liability for any consequence of customer product design, infringement of patents, or application assistance.