

IEC Appliance Inlet C14 with Circuit Breaker TA45



C14

 70° C

**Description**

- Panel Mount:
Screw-on mounting from front side
- 2 Functions:
Appliance Inlet Protection class 1, circuit breaker type TA45 2-pole
- Quick connect terminals 6.3 x 0.8 mm
- Alternative: version with line filter [5145](#)
- We recommend for new applications the new type [DF11](#)

Approvals

- VDE License Number: 117118
- UL License Number: E96454

Characteristics

- All single elements are already wired
Unwired versions available on request
- Line switch non-illuminated or illuminated
Thermal overload protection
Optional with undervoltage- or remote trip release
- Qualified for use in equipment according IEC/EN 60950

References

[General Product Information](#)

Weblinks

[Approvals](#), [RoHS](#), [CHINA-RoHS](#), [Mating Connectors](#), [e-Store](#), [Distributor-Stock-Check](#), [Accessories](#)

Technical Data

Ratings IEC	10A / 250VAC; 50Hz	Appliance Inlet	C14 acc. to IEC/EN 60320-1, UL 498, CSA C22.2 no. 42 (for cold conditions) pin-temperature 70 °C, 10A, Protection Class 1
Ratings UL/CSA	15A / 250VAC; 60Hz	Circuit Breakers	Acc. IEC/EN 60934, UL 1077, CSA 22.2 no. 235 2-pole rocker switch, illuminated or non-illuminated. Optional with undervoltage- or remote trip release Short circuit capacity Icn: at $I_n < 3A/240VAC$: $10 \times I_n$ at $I_n \geq 3A/240VAC$: 300A
Dielectric Strength	> 1.5kVAC between L/N-PE (1 min/50Hz)	Line Switch	Rocker switch 2-pole, non-illuminated or illuminated, acc. to IEC 61058-1 Technical details
Allowable Operation Temp.	-10°C to 55°C		
Degree of Protection	from front side IP 40 acc. to IEC 60529		
Protection Class	Suitable for appliances with protection class 1 acc. to IEC 61140		
Terminal	Quick connect terminals 6.3 x 0.8 mm		
Panel Thickness s	Screw: max 6mm Mounting screw torque max 0.5Nm		
Material: Housing	Thermoplastic, black, UL 94V-0		

Dimensions

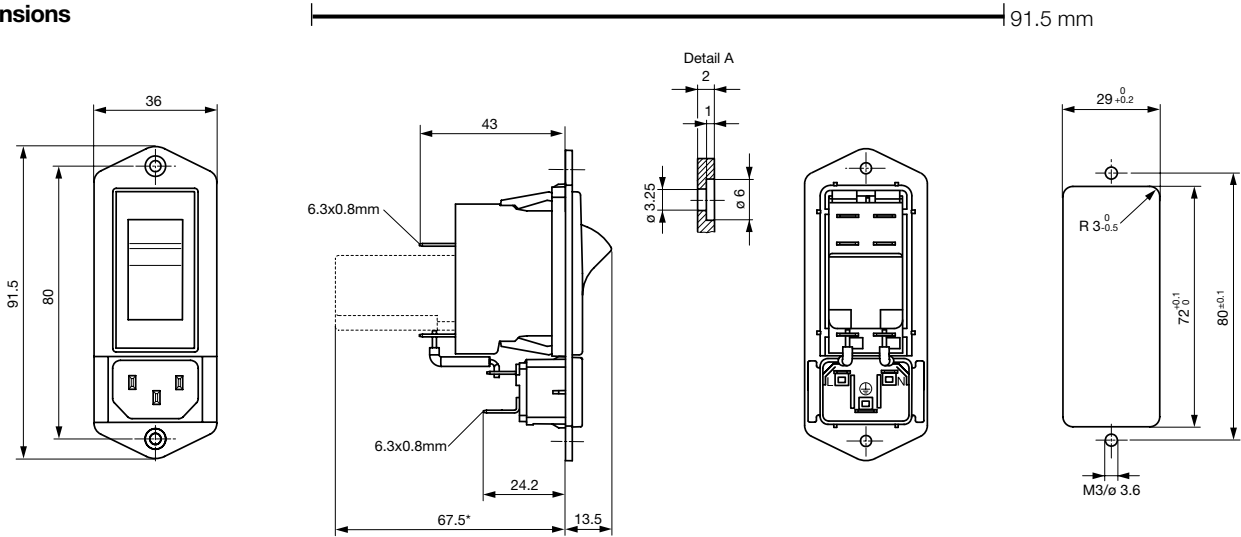

* --- Version TA45 with undervoltage release

Diagrams

Diagram

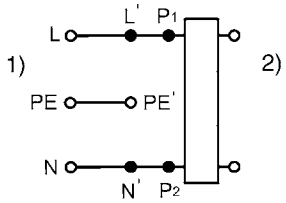

- 1) Line
- 2) Load

Table 1 Selection for type TA45

Order example



- Line switch
 - 2-pole, rocker actuated
 - Quick connect terminal
- Other types on request

ABT W F 150 C0

Diagram

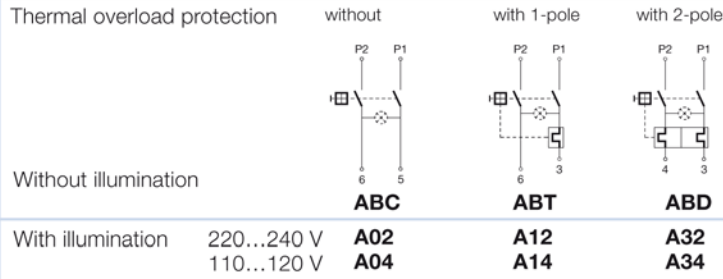

Colours

Switch front	Rocker
W black B black 6 black	white black - orange transp.

Rocker legend

Surface	Illustration	Colour of print	Surface	Illustration	Colour of print
F embossed / Relief			M printed		black
H printed / bedruckt		white / weiss	P printed		white
K printed / bedruckt		black / schwarz	R printed		black
L printed / bedruckt		white / weiss			

Position of the rocker legend
e.g F

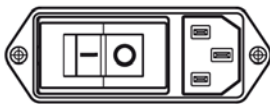

Rated current:

- Without thermal overload protection: code C00 } $I_n = 20\text{ A}$
- With thermal overload protection: rated current I_n (A)

I_n	Code	I_n	Code	I_n	Code	I_n	Code
0,1	J01	1,3	J13	2,8	J28	10,0	100
0,2	J02	1,4	J14	3,0	030	11,0	110
0,3	J03	1,5	J15	3,5	035	12,0	120
0,4	J04	1,6	J16	4,0	040	13,0	130
0,5	J05	1,7	J17	4,5	045	14,0	140
0,6	J06	1,8	J18	5,0	050	15,0	150
0,7	J07	1,9	J19	6,0	060		
0,8	J08	2,0	J20	6,5	065		
0,9	J09	2,1	J21	7,0	070		
1,0	J10	2,2	J22	7,5	075		
1,1	J11	2,3	J23	8,0	080		
1,2	J12	2,5	J25	9,0	090		

Without release: code C0

Undervoltage release

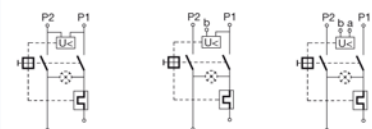

Code	Rated voltage U_n
•	240 V AC
•	230 V AC
•	120 V AC

Remote trip release

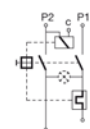

Code	Rated voltage U_n
•	240 V AC
•	230 V AC
•	120 V AC

Packaging unit 20 Pcs

Accessories

Description

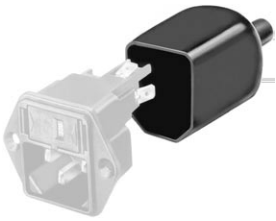

Assorted Covers
Rear Cover

0859.0074

Mating Outlets/Connectors

Category / Description

Appliance Outlet Overview complete



IEC Appliance Outlet F, Screw-on Mounting, Front Side, Solder or Quick-connect Terminal	4787
IEC Appliance Outlet F, Snap-in Mounting, Front Side, Solder or Quick-connect Terminal	4788
IEC Appliance Outlet F or H, Screw-on Mounting, Front Side, Solder, PCB or Quick-connect Terminal	5091
IEC Appliance Outlet F or H, Screw-on Mounting, Front Side, Solder or Quick-connect Terminal	5092

[Appliance Outlet further types to 6145](#)

Connector Overview complete



IEC Connector C15, Rewireable, Straight	0101
IEC Connector C15A, Rewireable, Straight	0102
IEC Connector C15A, Rewireable, Straight	0102-G
IEC Connector C15A, Rewireable, Angled	0112
IEC Connector C13, Rewireable, Angled	4012

[Connector further types to 6145](#)

Power Cord Overview complete



Power Cord with IEC Connector C13, Angled	0311
Power Cord with IEC Connector C13, Angled	3011
Power Cord with IEC Connector C13, Angled	3012
Power Cord with IEC Connector C13, Angled	3013
Power Cord with IEC Connector C13	3020

[Power Cord further types to 6145](#)

Technical data (continued)

Circuit breaker

Tripping characteristics

$I_n < 3 \text{ A}$

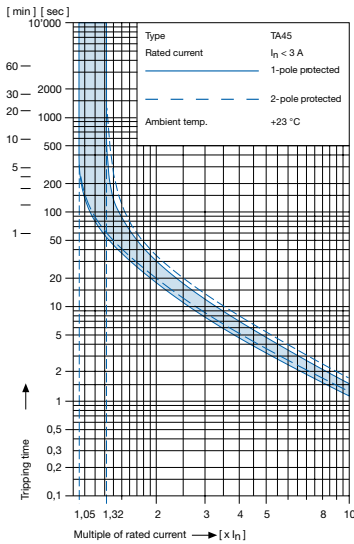

Tripping characteristics

$I_n \geq 3 \dots \leq 15 \text{ A}$

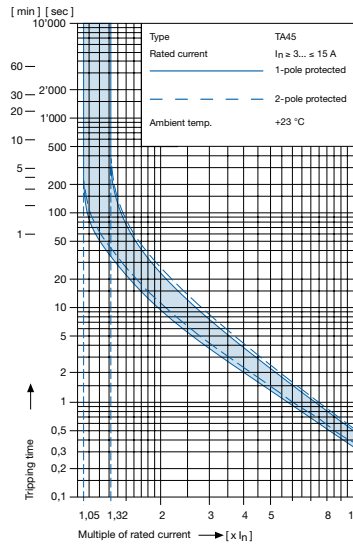

Effect of ambient temperature ¹⁾

The unit is calibrated for an ambient temperature of +23 °C. To determine the rated current for a lower or higher ambient temperature, use a correction factor from the table below.

*** Ambient temperature [°C] Correction factor**

-10	0,89
-5	0,91
0	0,92
+23	1,00
+30	1,03
+40	1,08
+55	1,16

* Temperature must be measured at the rear of the breaker next to the terminals after equipment operating temperature has been reached.

¹⁾ Example

Rated current at +23 °C	6,0 A
Ambient temperature	+40 °C
Correction factor	1,08
Chosen rated current at + 40 °C ambient temperature	6 A x 1,08 = 6,5 A

Order code (Order example)

Type	Order code TA 45 (2-pole rocker-switch without accessories)
6145.	A B T W F 1 5 0 C 0 . 0 0 1
	see table 1

Wiring
0 Without
1 With
2 Special (on request)

0 Without line filter
0 Without line filter

Please note that Schurter will establish an internal part number for logistical use in addition to the order code. The format of this internal part number is, for example 6145.0031.001