



LIGITEK

LIGITEK ELECTRONICS CO.,LTD.
Property of Ligitek Only

1W Power Light LED

LGLG-311E

DATA SHEET

DOC. NO : QW0905-LGLG-311E

REV. : A

DATE : 27 - Feb - 2009



Features

- *. High Flux per LED
- *. Very long operating life(up to 100k hours).
- *. Available in White.
- *. More Energy Efficient than Incandescent and most Halogen lamps.
- *. Low voltage DC operated..
- *. Cool beam, safe to the touch.
- *. Instant light(less than 100 ns).
- *. Fully dimmable.
- *. No UV.
- *. Superior ESD protection..
- *. Soldering methods: hand Soldering.

Typical Applications

- *. Reading Light (car,bus,aircraft)
- *. Portable(flashlight,bicycle).
- *. LCD Backlights / Light Guides.
- *. Automotive Exterior (Stop-Tail-Turn,CHMSL,Mirror Side Repeat).
- *. Commercial and Residential Architectural lighting.
- *. Mini-accent / Uplighters / Downlighters / Orientation lighting
- *. Fiber Optic Alternative / Decorative / Entertainment lighting.
- *. Security / Garden lighting.
- *. Cove / Undershelf / Task lighting.
- *. Traffic signaling / Beacons / Rail crossing and Wayside lighting.
- *. Decorative.
- *. Sign and channel Letter.

Dimension

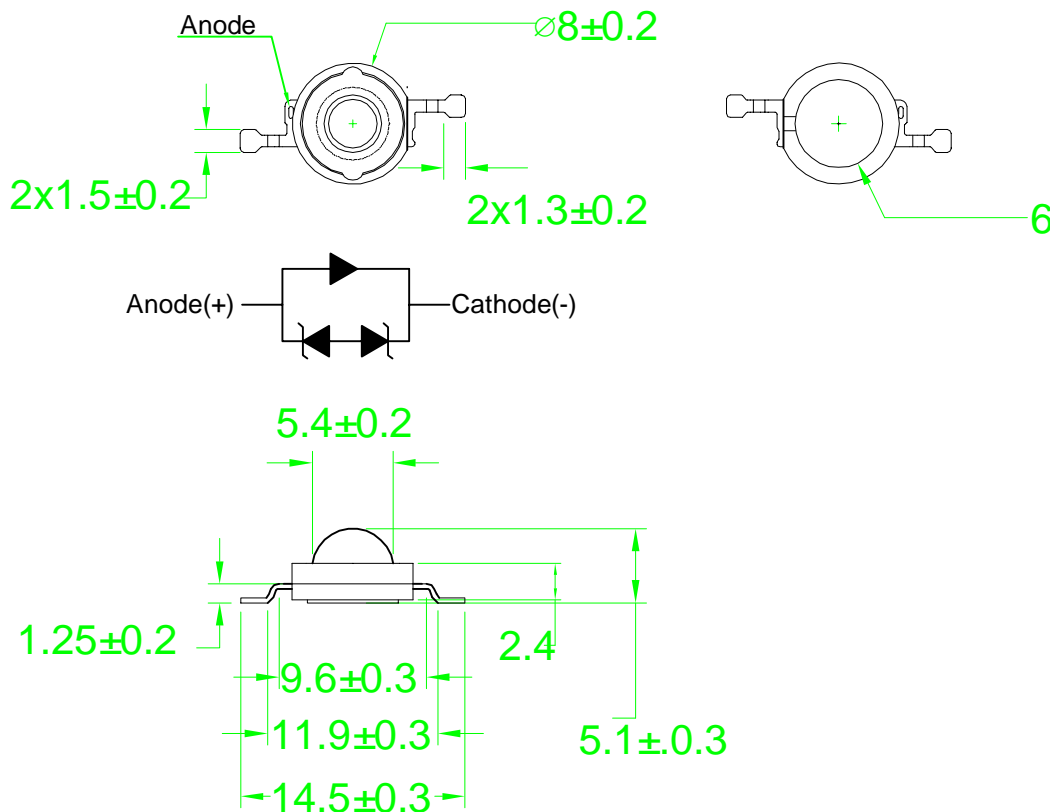

- Note:1. All dimension are in millimeter.
 2. The anode side of the device is denoted by a hole in the lead frame.
 3. The slug has polarity as anode.
 4. It is strongly recommended to apply on electrically isolated heat conducting film between the slug and contact surfaces.
 5. Drawings are not to scale.
 6. All dimensions without tolerances are for reference only.



Absolute Maximum Ratings at Ta=25

Parameter	Symbol	Ratings	UNIT
		True Green	
DC Forward Current	IF	350	mA
Power Dissipation	PD	1.4	W
Peak pulse current Duty 1/10@10KHz	IFP	500	mA
LED junction Temperature	Tj	125	
Reverse Current(VR=5V)	Ir	100	μ A
ESD Sensitivity	V _B	±4000	V
Storage Temperature	Tstg	-40 ~ +120	
Operating Temperature	Topr	-40 ~ +100	
Manual Soldering Time at 260°C(Max)	Tsol	5	seconds

NOTE:

1. Proper current derating must be observed to maintain temperature below the maximum.
2. LEDs are not designed to be driven in reverse bias.

Luminous Flux Characteristics at 350mA (Ratings At 25 Ambient)

Radiation Pattern	PART NO	Emission Color	Luminous Flux @350mA(I _m)			Units
			Min.	Typ.	Max.	I _m
Lambertian	LGLG-311E	True Green	30.6	55	----	

Note :

1. True Green emitters are built with InGaN.
2. Flux and power is measured with an accuracy of ±10%



. Forward Voltage Characteristics at 350mA

(Ratings At 25 Ambient)

Radiation Pattern	PART NO	Emission Color	Vf			Units
			Min.	Typ.	Max.	
Lambertian	LGLG-311E	True Green	2.8	3.6	4.0	V

Note : Forward Voltage is measured with an accuracy of ±0.1V

. Dominant Wavelength Characteristics at 350mA

(Ratings At 25 Ambient)

Radiation Pattern	PART NO	Emission Color	D			Units
			Min.	Typ.	Max.	
Lambertian	LGLG-311E	True Green	520	----	530	nm

. Temperature Coefficient Of Forward Voltage&Thermal Resistance Junction To Board Characteristics at 350mA

(Ratings At 25 Ambient)

Radiation Pattern	PART NO	Emission Color	$\Delta V_f/\Delta T$		Rth,j-B	
			Typ.	Units	Typ.	Units
Lambertian	LGLG-311E	True Green	-2	mV/°C	18	°C/W

. Emission Angle Characteristics at 350mA

(Ratings At 25 Ambient)

PART NO	Emission Color	Lambertian	Units
LGLG-311E	True Green	130	Degrees



Brightness Code For High Power LED

Group	Luminous flux(lm)	
	Min	Max
F21	30.6	39.8
F22	39.8	51.7
F23	51.7	67.2
F24-1	67.2	75

Note : Flux is measured with an accuracy of $\pm 10\%$



Recommended Solder Pad Design

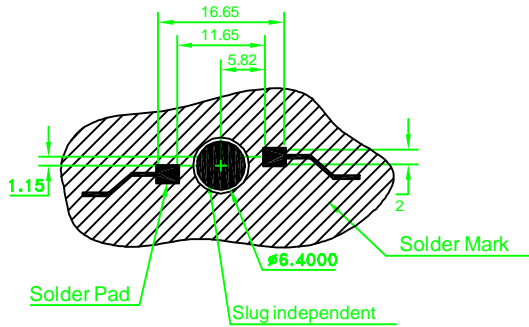

NOTE:

1. All dimensions are in mm.
2. The drawings are not to scale.
3. Solder pad can't be connected to slug.



Manual Hand Soldering

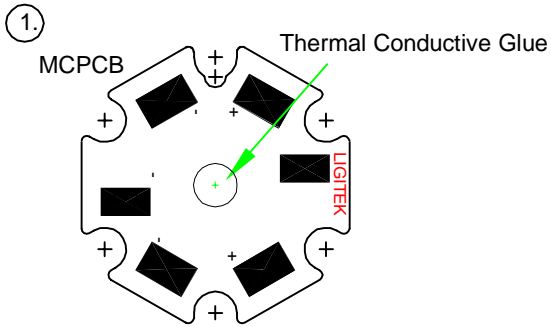

Place Thermal Conductive Glue on the MCPCB.

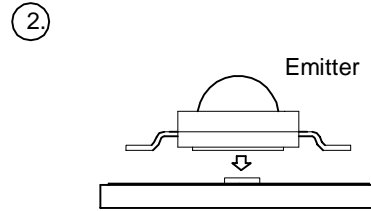

Place Emitter on the MCPCB.

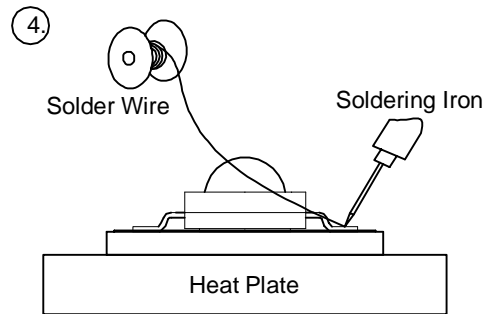
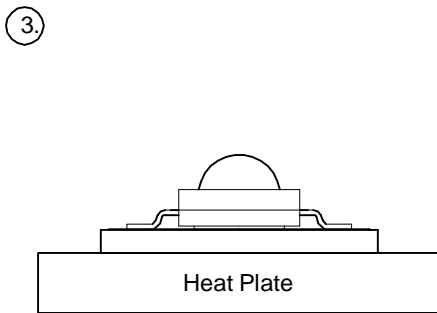

Use Soldering Iron to solder the leads of Emitter within 5 seconds.

- * For prototype builds or small series production runs it possible to place and solder the emitters by hand.
- * Solder tip temperature : 230°C max for Lead Solder and 260°C max for Lead-Free Solder.
- * Avoiding damage to the emitter or to the MCPCB dielectric layer.
Damage to the epoxy layer can cause a short circuit in the array.
- * Do not let the solder contact from solder pad to back-side of MCPCB.
This one will cause a short circuit and damage emitter.

Fig.1 Forward current vs. Forward Voltage

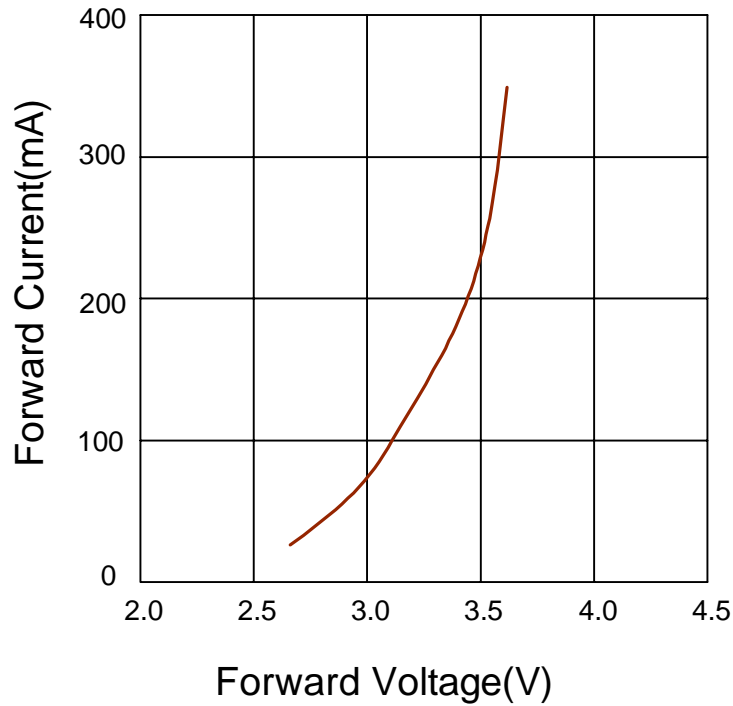

Fig.2 Operating current vs. Ambient Temperature

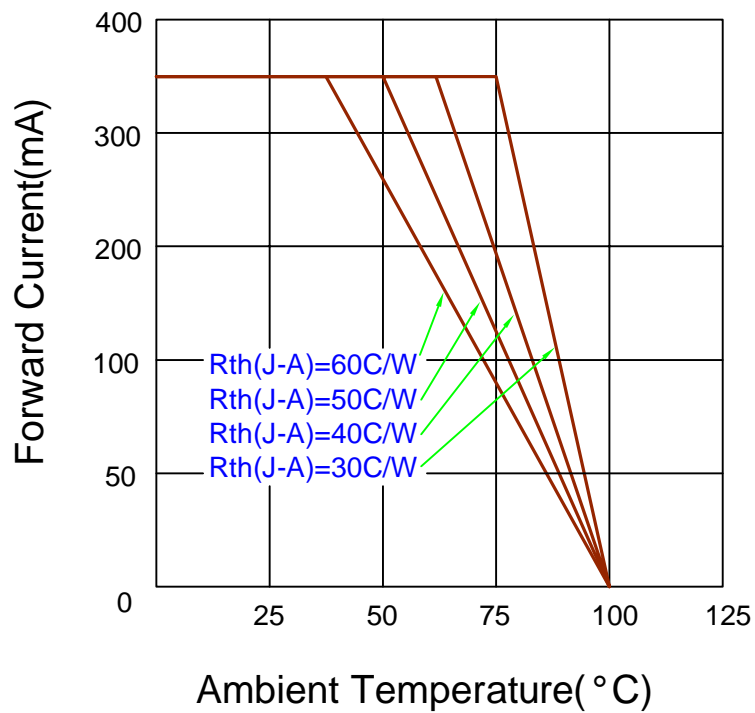



Fig.3 Forward current vs. Luminous Flux

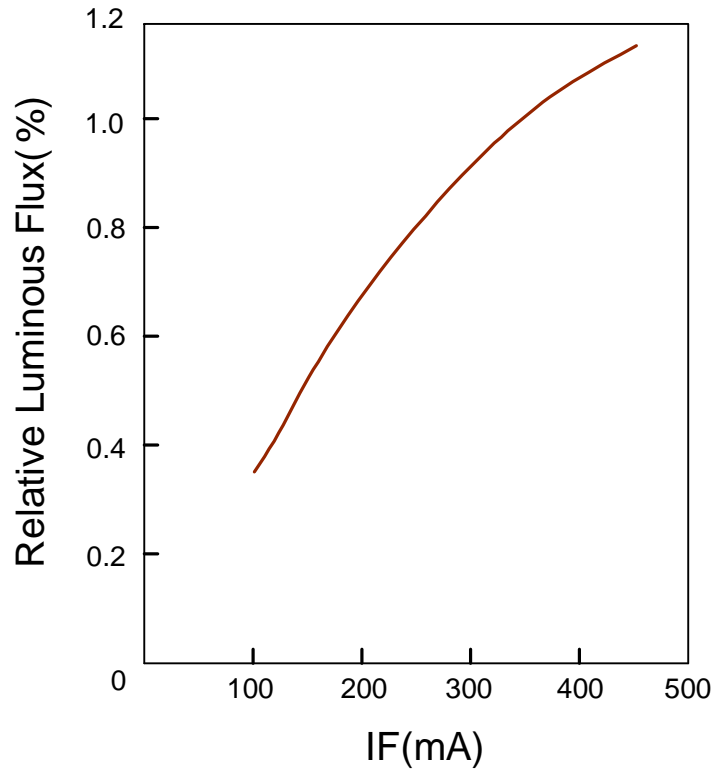

Fig.4 Junction Temperature vs. Forward Voltage

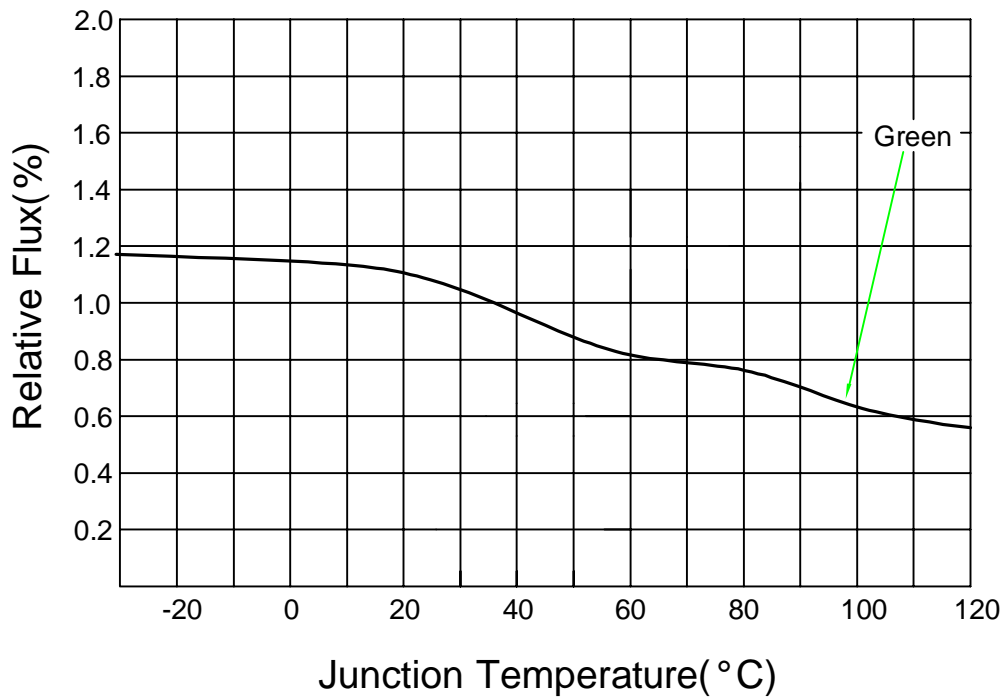



Fig.5 Relative Luminous Flux vs. Wavelength

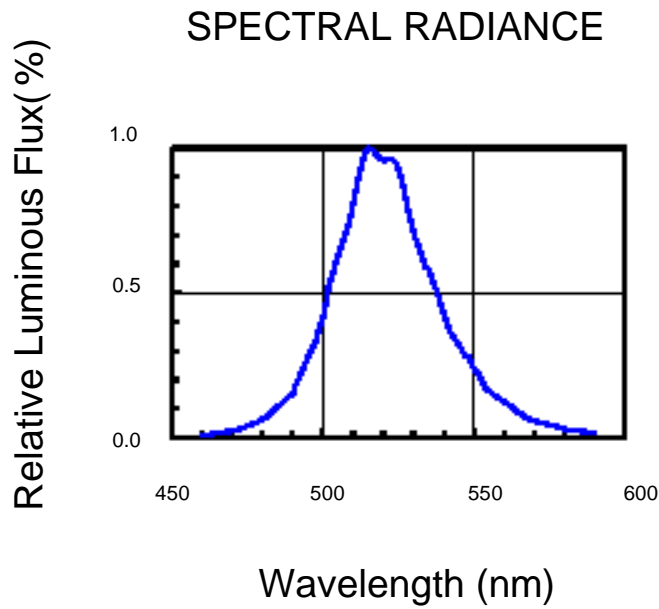
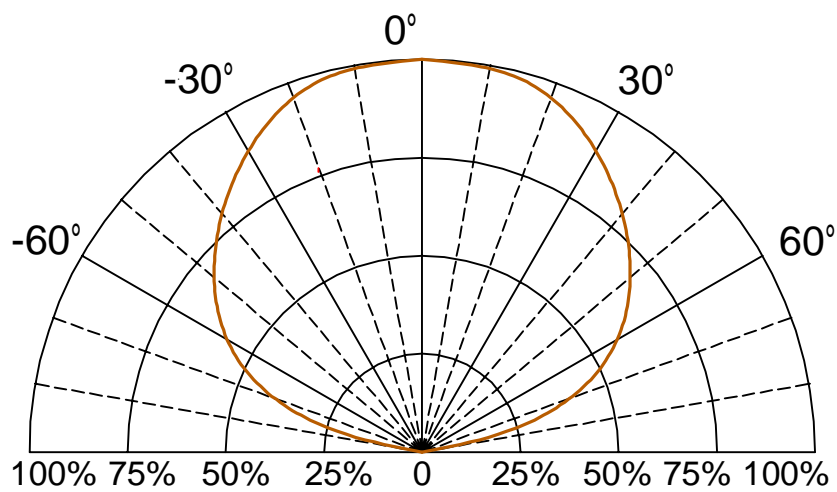

Fig.6 Directivity Radiation





PACKING SPECIFICATION

1. 35PCS / TUBE

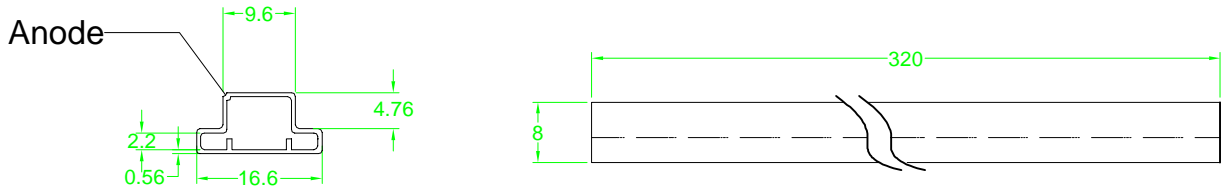

2. 30 TUBES / INNER BOX (10*3)

SIZE : L X W X H 33.5cm X 19cm X 7.5cm

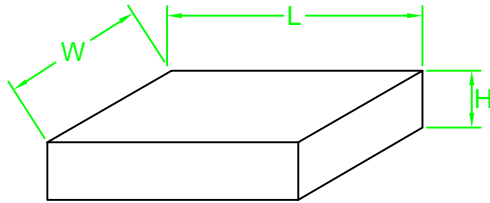

3. 12 INNER BOXES / CARTON

SIZE : L X W X H 58.5cm X 34cm X 34cm

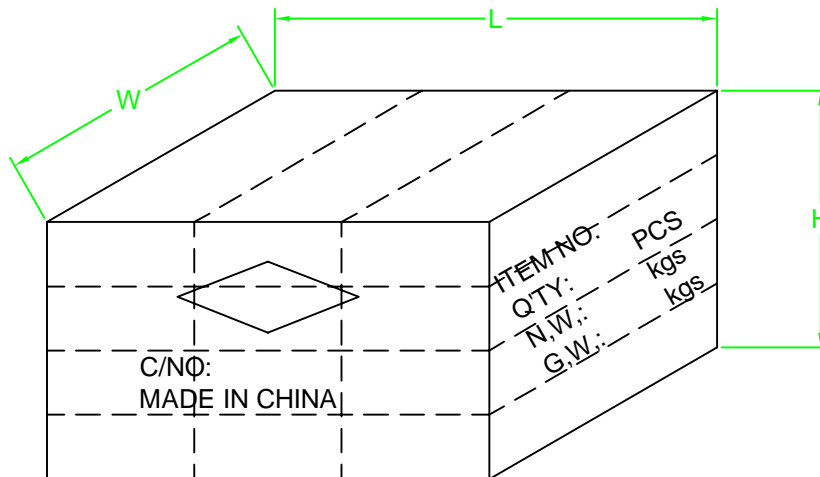



Reliability Test

Item	Description	Stress Condition	Test Duration
RTOL	Room Temperature Operation Life	25°C, Max. IF	1000 hours
WHT	Wet High Temperature	85°C/85%RH	1000 hours
TC	Temperature Cycling	-40/+110°C, 30min dwell,<5min trans.	200 cycles
TS	Thermal Shock	-40/+110°C, 20min dwell,<20min trans.	200 cycles
HTSL	High Temperature Storage Life	120°C	1000 hours
LTSL	Low Temperature Storage Life	-40°C	1000 hours
SHR	Solder Heat Resistance	260±5°C, 5secs	
MS	Mechanical Shock	1500G,0.5msec pulse, 5 shocks each 6 axis	
ND	Natural Drop	On concrete from 1.2m, 3times	
RV	Random Vibration	6G RMS from 10 to 2KHz, 10mins/axis	
VVF	Variable Vibration Frequency	10-2000-10Hz, 20G 1 min, 1.5mm, 3timesx/axis	

Note :

Failure criteria:

Electrical failures

V_F shife >= 10%

I_R < 50uA@V_r = 5v

Ligitek output Degradation

%I_v shift >= 30%@1000hrs or 200cycle

Visual failures

Broken or damaged package or lead

Dimension out of tolerance