

Diode Modules

PSKD 142

$$I_{FRMS} = 2x 300 A$$

$$I_{FAVM} = 2x 165 A$$

$$V_{RRM} = 800-1800 V$$

Preliminary Data Sheet

V_{RSM} V	V_{RRM} V	Type
900	800	PSKD 142/08
1300	1200	PSKD 142/12
1500	1400	PSKD 142/14
1700	1600	PSKD 142/16
1900	1800	PSKD 142/18

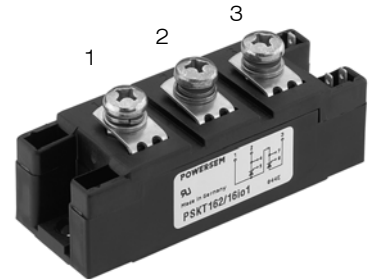
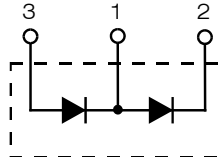

Symbol	Test Conditions	Maximum Ratings	
I_{FRMS}	$T_{VJ} = T_{VJM}$	300 A	
I_{FAVM}	$T_C = 100^\circ C$; 180° sine	165 A	
I_{FSM}	$T_{VJ} = 45^\circ C$; $V_R = 0$	t = 10 ms (50 Hz), sine	4700 A
		t = 8.3 ms (60 Hz), sine	5000 A
	$T_{VJ} = T_{VJM}$ $V_R = 0$	t = 10 ms (50 Hz), sine	4100 A
		t = 8.3 ms (60 Hz), sine	4300 A
$\int i^2 dt$	$T_{VJ} = 45^\circ C$ $V_R = 0$	t = 10 ms (50 Hz), sine	110 000 A ² s
		t = 8.3 ms (60 Hz), sine	104 000 A ² s
	$T_{VJ} = T_{VJM}$ $V_R = 0$	t = 10 ms (50 Hz), sine	84 000 A ² s
		t = 8.3 ms (60 Hz), sine	77 000 A ² s
T_{VJ}		-40...+150 °C	
T_{VJM}		150 °C	
T_{stg}		-40...+125 °C	
V_{ISOL}	50/60 Hz, RMS	t = 1 min	3000 V~
	$I_{ISOL} \leq 1 mA$	t = 1 s	3600 V~
M_d	Mounting torque (M6)	2.25-2.75/20-25 Nm/lb.in.	
	Terminal connection torque (M6)	4.5-5.5/40-48 Nm/lb.in.	
Weight	Typical including screws	120 g	

Features

- International standard package
- Direct copper bonded Al₂O₃ -ceramic base plate
- Planar passivated chips
- Isolation voltage 3600 V~
- UL registered, E 148688

Applications

- Supplies for DC power equipment
- DC supply for PWM inverter
- Field supply for DC motors
- Battery DC power supplies

Advantages

- Space and weight savings
- Simple mounting
- Improved temperature and power cycling
- Reduced protection circuits

Dimensions in mm (1 mm = 0.0394")

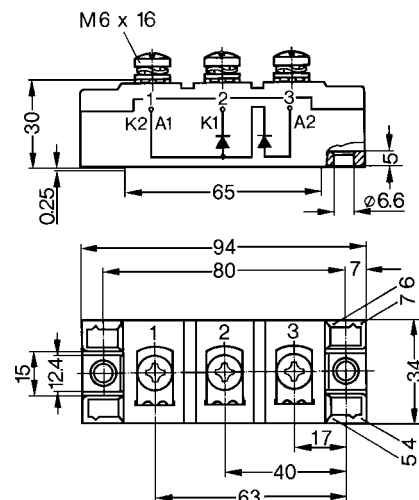

Symbol	Test Conditions	Characteristic Values
I_R	$T_{VJ} = T_{VJM}$; $V_R = V_{RRM}$	20 mA
V_F	$I_F = 300 A$; $T_{VJ} = 25^\circ C$	1.3 V
V_{TO}	For power-loss calculations only	0.8 V
r_T	$T_{VJ} = T_{VJM}$	1.3 mΩ
Q_S	$T_{VJ} = 125^\circ C$; $I_F = 300 A$, -di/dt = 50 A/μs	550 μC
I_{RM}		235 A
R_{thJC}	per diode; DC current	0.21 K/W
	per module	0.105 K/W
R_{thJK}	per diode; DC current	0.31 K/W
	per module	0.155 K/W
d_S	Creepage distance on surface	12.7 mm
d_A	Strike distance through air	9.6 mm
a	Maximum allowable acceleration	50 m/s ²

Data according to IEC 60747 and refer to a single thyristor/diode unless otherwise stated.

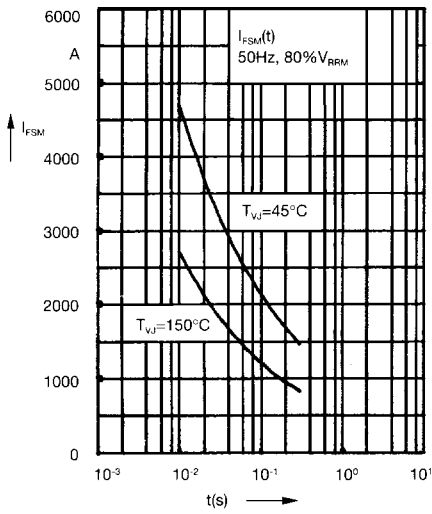

Fig. 1 Surge overload current
 I_{FSM} : Crest value, t: duration

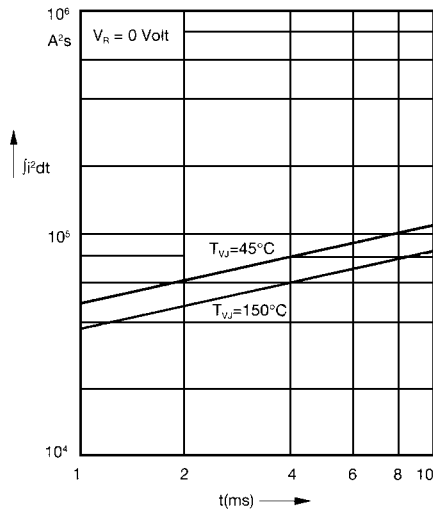

Fig. 2 j^2dt versus time (1-10 ms)

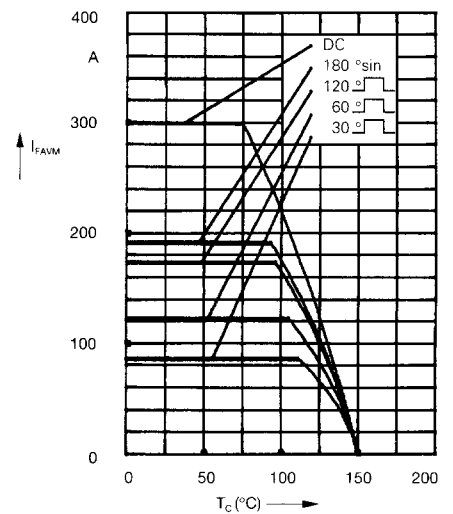

Fig. 2a Maximum forward current at case temperature

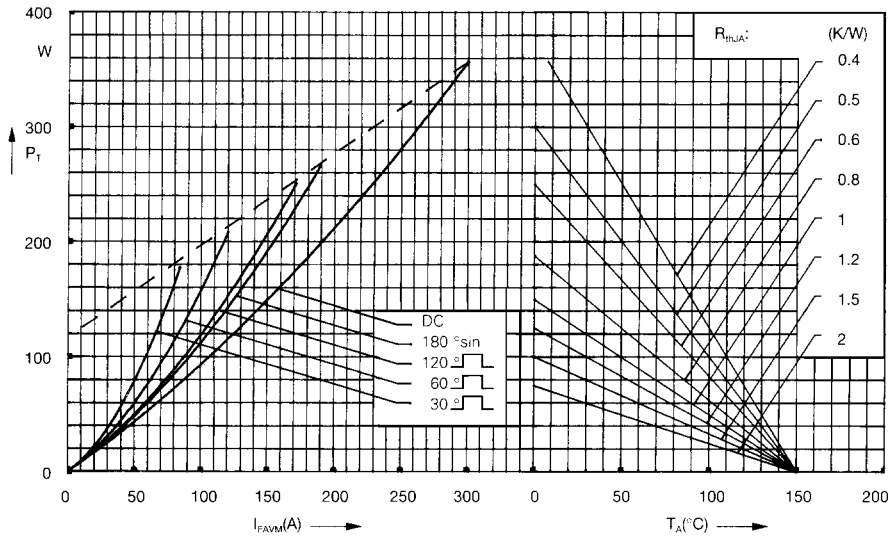

Fig. 3 Power dissipation versus forward current and ambient temperature (per diode)

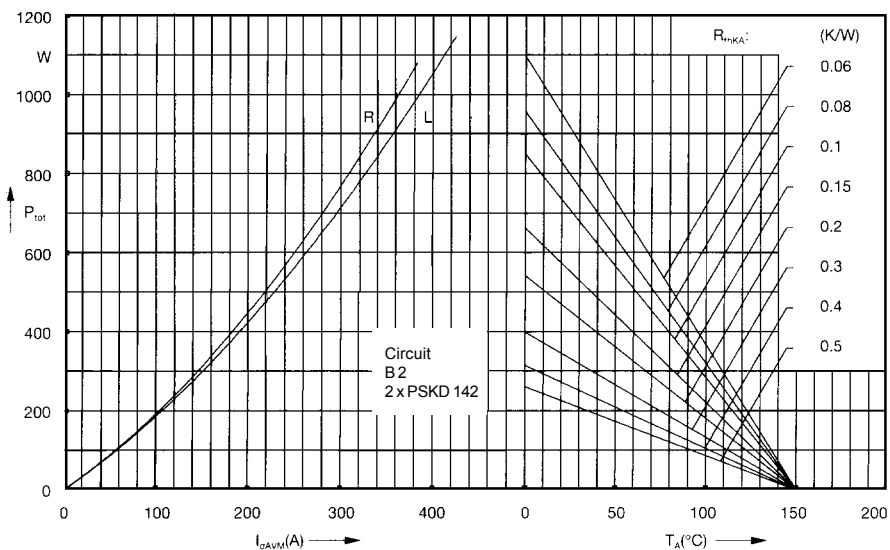

Fig. 4 Single phase rectifier bridge:
 Power dissipation versus direct output current and ambient temperature
 R = resistive load
 L = inductive load

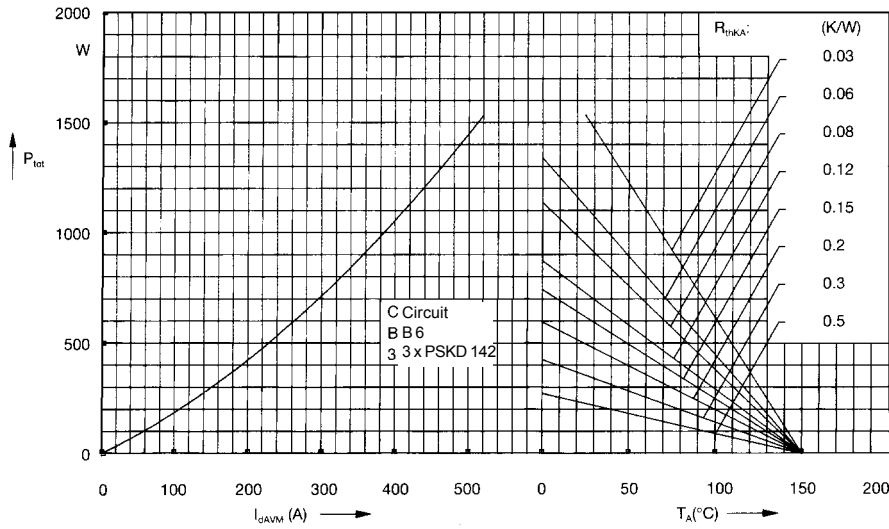

Fig. 5 Three phase rectifier bridge:
Power dissipation versus direct
output current and ambient
temperature

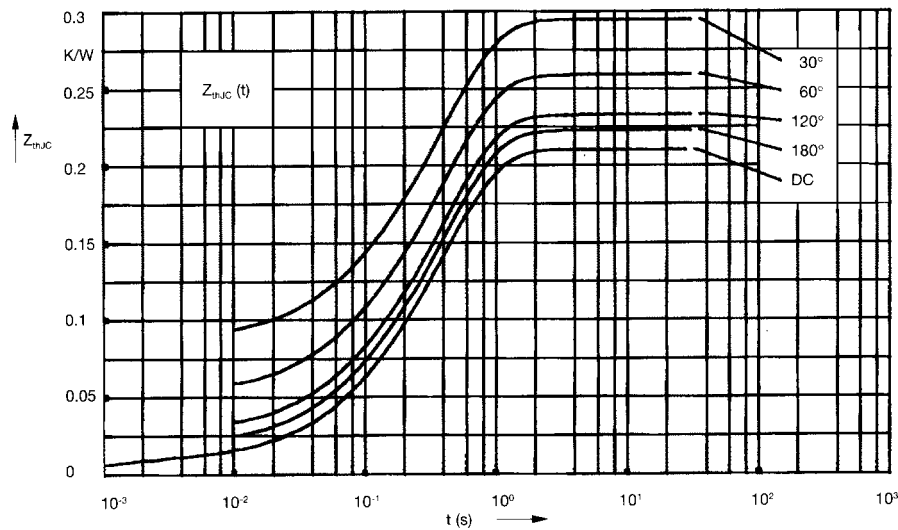

Fig. 6 Transient thermal impedance
junction to case (per diode)

R_{thjC} for various conduction angles d :

d	R_{thjC} (K/W)
DC	0.210
180°	0.223
120°	0.233
60°	0.260
30°	0.295

Constants for Z_{thjC} calculation:

i	R_{thi} (K/W)	t_i (s)
1	0.0087	0.001
2	0.0163	0.065
3	0.185	0.4

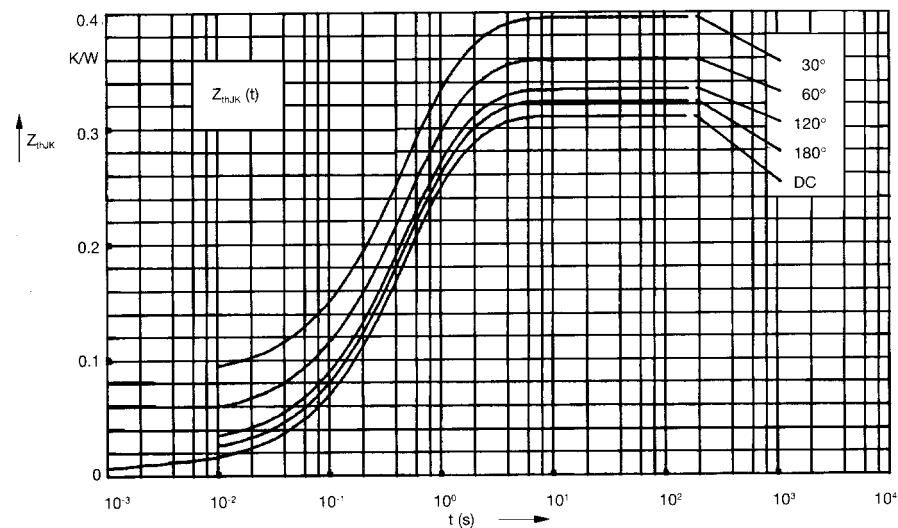

Fig. 7 Transient thermal impedance
junction to heatsink (per diode)

R_{thjK} for various conduction angles d :

d	R_{thjK} (K/W)
DC	0.31
180°	0.323
120°	0.333
60°	0.360
30°	0.395

Constants for Z_{thjK} calculation:

i	R_{thi} (K/W)	t_i (s)
1	0.0087	0.001
2	0.0163	0.065
3	0.185	0.4
4	0.1	1.29