

STRUCTURE	Silicon monolithic integrated circuits
PRODUCT SERIES	Bipolar stepping motor driver
TYPE	BD63875EFV
FUNCTION	<ul style="list-style-type: none"> • PWM constant current controllable two H bridge driver • Built-in translator circuit for CLK-IN control • Full, Half, and Quarter step modes • Mix decay control

○Absolute maximum ratings(Ta=25°C)

Item	Symbol	Limit	Unit
Supply voltage	V _{CC1,2}	-0.2~+36.0	V
Power dissipation	Pd	1.45 ^{※1}	W
		4.70 ^{※2}	W
Input voltage for control pin	V _{IN}	-0.2~+5.5	V
RNF maximum voltage	V _{RNF}	0.7	V
Maximum output current	I _{OUT}	1.5 ^{※3}	A/phase
Maximum output current(peak) ^{※4}	I _{OUTPEAK}	2.0 ^{※3}	A/phase
Operating temperature range	T _{opr}	-25~+85	°C
Storage temperature range	T _{stg}	-55~+150	°C
Junction temperature	T _{jmax}	+150	°C

※1 70mm × 70mm × 1.6mm glass epoxy board. Derating in done at 11.6mW/°C for operating above Ta=25°C.

※2 4-layer recommended board. Derating in done at 37.6mW/°C for operating above Ta=25°C.

※3 Do not, however exceed Pd, ASO and T_{jmax}=150°C.

※4 Pulse width $t_w \leq 1\text{ms}$, duty 20%.

○Recommended operating conditions (Ta=-25~+85°C)

Item	Symbol	Min.	Typ.	Max.	Unit
Supply voltage	V _{CC1,2}	19	24	28	V
Output current	I _{OUT}	-	1.0	1.2 ^{※5}	A/phase

※5 Do not, however exceed Pd, ASO.

This product isn't designed for protection against radioactive rays.

Status of this document

The Japanese version of this document is the formal specification.

A customer may use this translation version only for a reference to help reading the formal version.

If there are any differences in translation version of this document, formal version takes priority.

○Electrical characteristics (Unless otherwise specified, Ta=25°C, V_{CC1,2}=24V)

Item	Symbol	Limit			Unit	Conditions
		Min.	Typ.	Max.		
Whole						
Circuit current at standby	I _{CCST}	-	1.0	2.5	mA	PS=L
Circuit current	I _{CC}	-	2.5	5.0	mA	PS=H, VREF=3V
Control input (CLK, CW_CCW, MODE0, MODE1, ENABLE, PS)						
H level input voltage	V _{INH}	2.0	-	-	V	
L level input voltage	V _{INL}	-	-	0.8	V	
H level input current	I _{INH}	35	50	100	μA	V _{IN} =5V
L level input current	I _{INL}	-10	0	-	μA	V _{IN} =0V
Output (OUT1A, OUT1B, OUT2A, OUT2B)						
Output ON resistance	R _{ON}	-	1.0	1.3	Ω	I _{OUT} =1.0A, Sum of upper and lower
Output leak current	I _{LEAK}	-	-	10	μA	
Current control						
RNFXS input current	I _{RNFS}	-2.0	-0.1	-	μA	RNFXS=0V
RNFX input current	I _{RNF}	-40	-20	-	μA	RNFX=0V
VREF input current	I _{VREF}	-2.0	-0.1	-	μA	VREF=0V
VREF input voltage range	V _{REF}	0	-	3.0	V	
MTH input current	I _{MTH}	-2.0	-0.1	-	μA	MTH=0V
MTH input voltage range	V _{MTH}	0	-	3.5	V	
Comparator threshold	V _{CTH}	0.57	0.60	0.63	V	VREF=3V
Minimum on time (Blank time)	t _{ONMIN}	0.3	0.8	1.5	μs	C=1000pF, R=39kΩ

OPackage outline

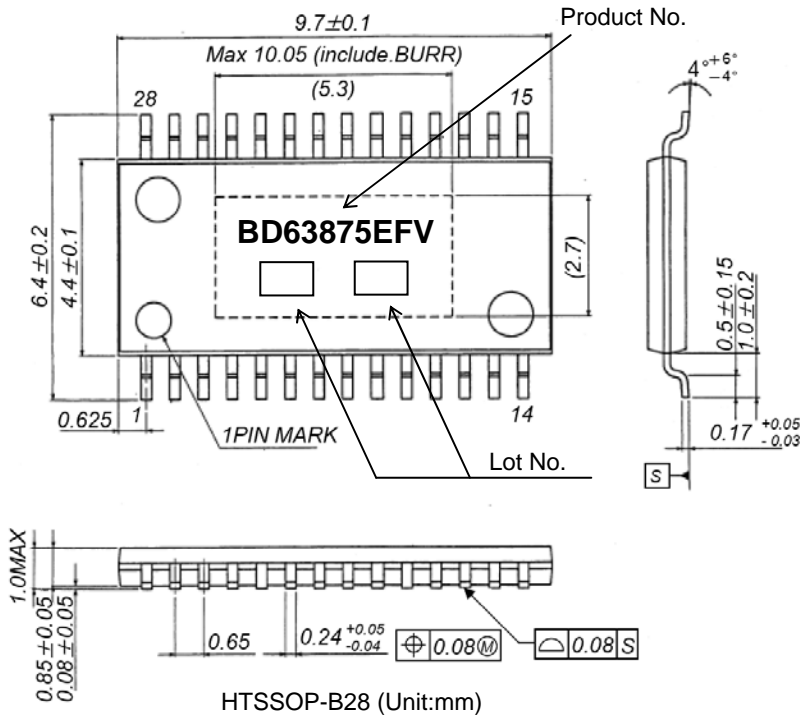

OBlock diagram

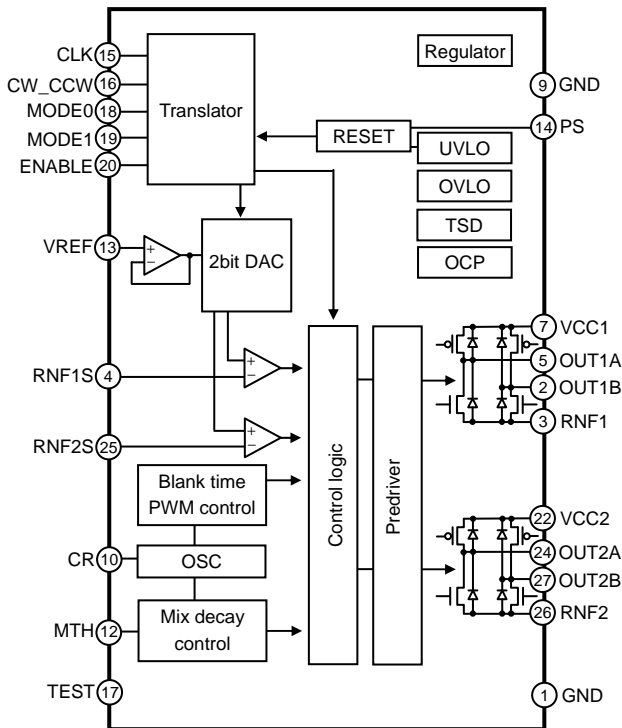

OPin No. / Pin name

Pin No.	Pin name	Pin No.	Pin name
1	GND	15	CLK
2	OUT1B	16	CW_CCW
3	RNF1	17	TEST
4	RNF1S	18	MODE0
5	OUT1A	19	MODE1
6	NC	20	ENABLE
7	VCC1	21	NC
8	NC	22	VCC2
9	GND	23	NC
10	CR	24	OUT2A
11	NC	25	RNF2S
12	MTH	26	RNF2
13	VREF	27	OUT2B
14	PS	28	NC

NC : Non Connection

○Operation Notes

- (1) Absolute maximum ratings
An excess in the absolute maximum ratings, such as supply voltage, temperature range of operating conditions, etc., can break down the devices, thus making impossible to identify breaking mode, such as a short circuit or an open circuit. If any over rated values will expect to exceed the absolute maximum ratings, consider adding circuit protection devices, such as fuses.
- (2) Power supply lines
As return of current regenerated by back EMF of motor happens, take steps such as putting capacitor between power supply and GND as an electric pathway for the regenerated current. Be sure that there is no problem with each property such as emptied capacity at lower temperature regarding electrolytic capacitor to decide capacity value. If the connected power supply does not have sufficient current absorption capacity, regenerative current will cause the voltage on the power supply line to rise, which combined with the product and its peripheral circuitry may exceed the absolute maximum ratings. It is recommended to implement a physical safety measure such as the insertion of a voltage clamp diode between the power supply and GND pins.
- (3) GND potential
The potential of GND pin must be minimum potential in all operating conditions.
- (4) Metal on the backside (Define the side where product markings are printed as front)
The metal on the backside is shorted with the backside of IC chip therefore it should be connected to GND. Be aware that there is a possibility of malfunction or destruction if it is shorted with any potential other than GND.
- (5) Thermal design
Use a thermal design that allows for a sufficient margin in light of the power dissipation (Pd) in actual operating conditions. This IC exposes its frame of the backside of package. Note that this part is assumed to use after providing heat dissipation treatment to improve heat dissipation efficiency . Try to occupy as wide as possible with heat dissipation pattern not only on the board surface but also the backside.
- (6) Actions in strong electromagnetic field
Use caution when using the IC in the presence of a strong electromagnetic field as doing so may cause the IC to malfunction.
- (7) ASO
When using the IC, set the output transistor so that it does not exceed absolute maximum ratings or ASO.
- (8) Thermal shutdown circuit
The IC has a built-in thermal shutdown circuit (TSD circuit). If the chip temperature becomes $T_{jmax}=150^{\circ}\text{C}$, and higher, coil output to the motor will be open. The TSD circuit is designed only to shut the IC off to prevent runaway thermal operation. It is not designed to protect or indemnify peripheral equipment. Do not use the TSD function to protect peripheral equipment.
- (9) Ground Wiring Pattern
When using both large current and small signal GND patterns, it is recommended to isolate the two ground patterns, placing a single ground point at the ground potential of application so that the pattern wiring resistance and voltage variations caused by large currents do not cause variations in the small signal ground voltage. Be careful not to change the GND wiring pattern of any external components, either.
- (10) TEST pin
Be sure to connect TEST pin to GND.

Notes

No copying or reproduction of this document, in part or in whole, is permitted without the consent of ROHM CO.,LTD.

The content specified herein is subject to change for improvement without notice.

The content specified herein is for the purpose of introducing ROHM's products (hereinafter "Products"). If you wish to use any such Product, please be sure to refer to the specifications, which can be obtained from ROHM upon request.

Examples of application circuits, circuit constants and any other information contained herein illustrate the standard usage and operations of the Products. The peripheral conditions must be taken into account when designing circuits for mass production.

Great care was taken in ensuring the accuracy of the information specified in this document. However, should you incur any damage arising from any inaccuracy or misprint of such information, ROHM shall bear no responsibility for such damage.

The technical information specified herein is intended only to show the typical functions of and examples of application circuits for the Products. ROHM does not grant you, explicitly or implicitly, any license to use or exercise intellectual property or other rights held by ROHM and other parties. ROHM shall bear no responsibility whatsoever for any dispute arising from the use of such technical information.

The Products specified in this document are intended to be used with general-use electronic equipment or devices (such as audio visual equipment, office-automation equipment, communication devices, electronic appliances and amusement devices).

The Products are not designed to be radiation tolerant.

While ROHM always makes efforts to enhance the quality and reliability of its Products, a Product may fail or malfunction for a variety of reasons.

Please be sure to implement in your equipment using the Products safety measures to guard against the possibility of physical injury, fire or any other damage caused in the event of the failure of any Product, such as derating, redundancy, fire control and fail-safe designs. ROHM shall bear no responsibility whatsoever for your use of any Product outside of the prescribed scope or not in accordance with the instruction manual.

The Products are not designed or manufactured to be used with any equipment, device or system which requires an extremely high level of reliability the failure or malfunction of which may result in a direct threat to human life or create a risk of human injury (such as a medical instrument, transportation equipment, aerospace machinery, nuclear-reactor controller, fuel-controller or other safety device). ROHM shall bear no responsibility in any way for use of any of the Products for the above special purposes. If a Product is intended to be used for any such special purpose, please contact a ROHM sales representative before purchasing.

If you intend to export or ship overseas any Product or technology specified herein that may be controlled under the Foreign Exchange and the Foreign Trade Law, you will be required to obtain a license or permit under the Law.

Thank you for your accessing to ROHM product informations.

More detail product informations and catalogs are available, please contact your nearest sales office.

ROHM Customer Support System

THE AMERICAS / EUROPE / ASIA / JAPAN

www.rohm.com

Contact us : webmaster@rohm.co.jp