

Miniature Basic Switch D3V

Reliable Basic Switch with External Lever

- Available by 0.1 A, 6 A, 11 A, 16 A and 21 A models, all with self-cleaning contacts. 0.1 A utilizes gold alloy crossbar contacts for high reliability at low loads.
- Available with internally or externally fitted levers, and 2 fixing positions for external levers.
- Conforms to EN61058-1 UL1054.
- High Temperature models rated up to 200°C (D3V-6, D3V-01) and 155°C (D3V-11) are available.
- RoHS Compliant.



Ordering Information

Model Number Legend

D3V - - - - -

1 2 3 4 5 6 7 8 9 10

1. Ratings

- 21: 20 (4) A at 250 VAC
- 16: 16 (3) A at 250 VAC
- 11: 11 (3) A at 250 VAC
- 6: 6 (2) A at 250 VAC
- 01: 0.1 A at 125 VAC

2. Contact Gap

- None: 1 mm (F gap)
- G: 0.5 mm (G gap)

3. Actuator

- None: Pin plunger
- 1: Short hinge lever
- 2: Hinge lever
- 3: Long hinge lever
- 4: Simulated roller lever
- 5: Short hinge roller lever
- 6: Hinge roller lever

4. Hinge Position

- None: Internal / Far from Plunger
- M: External / Far from Plunger
- K: External / Near Plunger

5. Contact Form

- 1: SPDT
- 2: SPST-NC
- 3: SPST-NO

6. Terminals

- A: Solder terminals
- C2: Quick-connect terminal (#187)
- C: Quick-connect terminal (#250)
- C6: RAST5 terminal (#250)

7. Maximum Operating Force

- 5: 200 gf
 - 4A: 125 gf
 - 4: 100 gf
 - 3: 50 gf
 - 2: 25 gf
- Note:** These OF values are for the pin plunger models.

8. Enclosure Material

- None: Standard
- T: High Temperature
200°C for D3V-6, D3V-01
155°C for D3V-11
- W2: EN60695-2-11/-12 Approved
(Glow wire flammability test method with PTI = 250)

9. Mounting Hole Size

- None: 3.1 mm
- K: 2.9 mm

10. Special Code

- None: Standard
- H: High Temperature (125°C)
- E: Special Rating: 21 (8) A
(D3V-21, only)







Available Combinations

Heat resistance	Terminals	Model	D3V-16			D3V-11			D3V-6			D3V-01			
		Rated current	16 A			11 A			6 A			0.1 A			
		OF	200 gf	100 gf	200 gf	100 gf	50 gf	200 gf	100 gf	50 gf	50 gf	25 gf			
		Contact gap	F/G 1 mm or 0.5 mm	F/G 1 mm or 0.5 mm	F 1 mm	G 0.5 mm	F 1 mm	G 0.5 mm	G 0.5 mm	F/G 1 mm or 0.5 mm	F 1 mm	G 0.5 mm	G 0.5 mm	F/G 1 mm or 0.5 mm	
Standard (85°C)	#187												○	○	
	#250	○												○	○
	RAST5													○	○
Standard (105°C)	#187		○	○	○	○	○	○	○	○	○	○			
	#250		○	○	○	○	○	○	○	○	○	○			
	RAST5							○				○			
EN60695-2-11 approved W2: 85°C	#187													○	○
	#250													○	○
														○	○
EN60695-2-11 approved W2: 105°C	#187		○												
	#250		○		○			○				○			
	RAST5							○							
High temperature H: 125°C	#187		○	○	○	○	○	○	○	○	○	○			
	#250		○	○	○	○	○	○	○	○	○	○			
	RAST5														
High temperature T: 155°C	#187				○	○	○	○	○						
	#250				○	○	○	○	○						
	RAST5								○						
High temperature T: 200°C	#187									○	○	○	○	○	○
	#250									○	○	○	○	○	○
	RAST5											○	○		



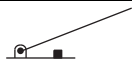



Note: 1. ○: Available model.
2. Consult OMRON for specific models with standard approval.

List of Models







21 A (OF: 125 gf)

Actuator	Hinge position (far from plunger)	Contact form		
		SPDT	SPST-NC	SPST-NO
Pin plunger 	---	D3V-21G-1□4A-Δ-▽	D3V-21G-2□4A-Δ-▽	D3V-21G-3□4A-Δ-▽
Short hinge lever 	Internal	D3V-21G1-1□4A-Δ-▽	D3V-21G1-2□4A-Δ-▽	D3V-21G1-3□4A-Δ-▽
	External (M)	D3V-21G1M-1□4A-Δ-▽	D3V-21G1M-2□4A-Δ-▽	D3V-21G1M-3□4A-Δ-▽
Hinge lever 	Internal	D3V-21G2-1□4A-Δ-▽	D3V-21G2-2□4A-Δ-▽	D3V-21G2-3□4A-Δ-▽
	External (M)	D3V-21G2M-1□4A-Δ-▽	D3V-21G2M-2□4A-Δ-▽	D3V-21G2M-3□4A-Δ-▽
Long hinge lever 	Internal	D3V-21G3-1□4A-Δ-▽	D3V-21G3-2□4A-Δ-▽	D3V-21G3-3□4A-Δ-▽
	External (M)	D3V-21G3M-1□4A-Δ-▽	D3V-21G3M-2□4A-Δ-▽	D3V-21G3M-3□4A-Δ-▽
Simulated roller lever 	Internal	D3V-21G4-1□4A-Δ-▽	D3V-21G4-2□4A-Δ-▽	D3V-21G4-3□4A-Δ-▽
	External (M)	D3V-21G4M-1□4A-Δ-▽	D3V-21G4M-2□4A-Δ-▽	D3V-21G4M-3□4A-Δ-▽
Short hinge roller lever 	Internal	D3V-21G5-1□4A-Δ-▽	D3V-21G5-2□4A-Δ-▽	D3V-21G5-3□4A-Δ-▽
	External (M)	D3V-21G5M-1□4A-Δ-▽	D3V-21G5M-2□4A-Δ-▽	D3V-21G5M-3□4A-Δ-▽
Hinge roller lever 	Internal	D3V-21G6-1□4A-Δ-▽	D3V-21G6-2□4A-Δ-▽	D3V-21G6-3□4A-Δ-▽
	External (M)	D3V-21G6M-1□4A-Δ-▽	D3V-21G6M-2□4A-Δ-▽	D3V-21G6M-3□4A-Δ-▽







16 A (OF: 200 gf)

Actuator	Hinge position (far from plunger)	Contact form		
		SPDT	SPST-NC	SPST-NO
Pin plunger 	---	D3V-16-1□5-●-△-▽	D3V-16-2□5-●-△-▽	D3V-16-3□5-●-△-▽
Short hinge lever 	Internal	D3V-161-1□5-●-△-▽	D3V-161-2□5-●-△-▽	D3V-161-3□5-●-△-▽
	External (M)	D3V-161M-1□5-●-△-▽	D3V-161M-2□5-●-△-▽	D3V-161M-3□5-●-△-▽
Hinge lever 	Internal	D3V-162-1□5-●-△-▽	D3V-162-2□5-●-△-▽	D3V-162-3□5-●-△-▽
	External (M)	D3V-162M-1□5-●-△-▽	D3V-162M-2□5-●-△-▽	D3V-162M-3□5-●-△-▽
Long hinge lever 	Internal	D3V-163-1□5-●-△-▽	D3V-163-2□5-●-△-▽	D3V-163-3□5-●-△-▽
	External (M)	D3V-163M-1□5-●-△-▽	D3V-163M-2□5-●-△-▽	D3V-163M-3□5-●-△-▽
Simulated roller lever 	Internal	D3V-164-1□5-●-△-▽	D3V-164-2□5-●-△-▽	D3V-164-3□5-●-△-▽
	External (M)	D3V-164M-1□5-●-△-▽	D3V-164M-2□5-●-△-▽	D3V-164M-3□5-●-△-▽
Short hinge roller lever 	Internal	D3V-165-1□5-●-△-▽	D3V-165-2□5-●-△-▽	D3V-165-3□5-●-△-▽
	External (M)	D3V-165M-1□5-●-△-▽	D3V-165M-2□5-●-△-▽	D3V-165M-3□5-●-△-▽
Hinge roller lever 	Internal	D3V-166-1□5-●-△-▽	D3V-166-2□5-●-△-▽	D3V-166-3□5-●-△-▽
	External (M)	D3V-166M-1□5-●-△-▽	D3V-166M-2□5-●-△-▽	D3V-166M-3□5-●-△-▽

16 A (OF: 100 gf)

Actuator	Hinge position (far from plunger)	Contact form		
		SPDT	SPST-NC	SPST-NO
Pin plunger 	---	D3V-16-1□4-●-△-▽	D3V-16-2□4-●-△-▽	D3V-16-3□4-●-△-▽
Short hinge lever 	Internal	D3V-161-1□4-●-△-▽	D3V-161-2□4-●-△-▽	D3V-161-3□4-●-△-▽
	External (M)	D3V-161M-1□4-●-△-▽	D3V-161M-2□4-●-△-▽	D3V-161M-3□4-●-△-▽
Hinge lever 	Internal	D3V-162-1□4-●-△-▽	D3V-162-2□4-●-△-▽	D3V-162-3□4-●-△-▽
	External (M)	D3V-162M-1□4-●-△-▽	D3V-162M-2□4-●-△-▽	D3V-162M-3□4-●-△-▽
Long hinge lever 	Internal	D3V-163-1□4-●-△-▽	D3V-163-2□4-●-△-▽	D3V-163-3□4-●-△-▽
	External (M)	D3V-163M-1□4-●-△-▽	D3V-163M-2□4-●-△-▽	D3V-163M-3□4-●-△-▽
Simulated roller lever 	Internal	D3V-164-1□4-●-△-▽	D3V-164-2□4-●-△-▽	D3V-164-3□4-●-△-▽
	External (M)	D3V-164M-1□4-●-△-▽	D3V-164M-2□4-●-△-▽	D3V-164M-3□4-●-△-▽
Short hinge roller lever 	Internal	D3V-165-1□4-●-△-▽	D3V-165-2□4-●-△-▽	D3V-165-3□4-●-△-▽
	External (M)	D3V-165M-1□4-●-△-▽	D3V-165M-2□4-●-△-▽	D3V-165M-3□4-●-△-▽
Hinge roller lever 	Internal	D3V-166-1□4-●-△-▽	D3V-166-2□4-●-△-▽	D3V-166-3□4-●-△-▽
	External (M)	D3V-166M-1□4-●-△-▽	D3V-166M-2□4-●-△-▽	D3V-166M-3□4-●-△-▽







11 A (OF: 200 gf)

Actuator	Hinge position (far from plunger)	Contact form		
		SPDT	SPST-NC	SPST-NO
Pin plunger 	---	D3V-11-1□5-●-△-▽	D3V-11-2□5-●-△-▽	D3V-11-3□5-●-△-▽
Short hinge lever 	Internal	D3V-111-1□5-●-△-▽	D3V-111-2□5-●-△-▽	D3V-111-3□5-●-△-▽
	External (M)	D3V-111M-1□5-●-△-▽	D3V-111M-2□5-●-△-▽	D3V-111M-3□5-●-△-▽
Hinge lever 	Internal	D3V-112-1□5-●-△-▽	D3V-112-2□5-●-△-▽	D3V-112-3□5-●-△-▽
	External (M)	D3V-112M-1□5-●-△-▽	D3V-112M-2□5-●-△-▽	D3V-112M-3□5-●-△-▽
Long hinge lever 	Internal	D3V-113-1□5-●-△-▽	D3V-113-2□5-●-△-▽	D3V-113-3□5-●-△-▽
	External (M)	D3V-113M-1□5-●-△-▽	D3V-113M-2□5-●-△-▽	D3V-113M-3□5-●-△-▽
Simulated roller lever 	Internal	D3V-114-1□5-●-△-▽	D3V-114-2□5-●-△-▽	D3V-114-3□5-●-△-▽
	External (M)	D3V-114M-1□5-●-△-▽	D3V-114M-2□5-●-△-▽	D3V-114M-3□5-●-△-▽
Short hinge roller lever 	Internal	D3V-115-1□5-●-△-▽	D3V-115-2□5-●-△-▽	D3V-115-3□5-●-△-▽
	External (M)	D3V-115M-1□5-●-△-▽	D3V-115M-2□5-●-△-▽	D3V-115M-3□5-●-△-▽
Hinge roller lever 	Internal	D3V-116-1□5-●-△-▽	D3V-116-2□5-●-△-▽	D3V-116-3□5-●-△-▽
	External (M)	D3V-116M-1□5-●-△-▽	D3V-116M-2□5-●-△-▽	D3V-116M-3□5-●-△-▽



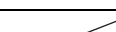



- The □ in the model number is for the terminal code.
 A: Solder/quick-connect terminals (#187)
 C2: Quick-connect terminals (#187)
 C: Quick-connect terminals (#250)
 C6: RAST5 terminals (#250)
- The ● in the model number is for the enclosure material
 None: Standard
 T: High Temperature (200°C for D3V-6/-01, 155°C for D3V-11)
 W2: EN60695-2-11/-12 conformity with PTI=250

- The △ in the model number is for the mounting hole size.
 None: 3.1 mm
 K: 2.9 mm
- The ▽ in the model number is for the special code
 None: Standard
 H: High Temperature (125°C)
 E: Special rating of 21A (8)A (for D3V-21 only)



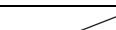



11 A (OF: 100 gf)

Actuator	Hinge position (far from plunger)	Contact form		
		SPDT	SPST-NC	SPST-NO
Pin plunger 	---	D3V-11-1□4-●-△-▽	D3V-11-2□4-●-△-▽	D3V-11-3□4-●-△-▽
Short hinge lever 	Internal	D3V-111-1□4-●-△-▽	D3V-111-2□4-●-△-▽	D3V-111-3□4-●-△-▽
	External (M)	D3V-111M-1□4-●-△-▽	D3V-111M-2□4-●-△-▽	D3V-111M-3□4-●-△-▽
Hinge lever 	Internal	D3V-112-1□4-●-△-▽	D3V-112-2□4-●-△-▽	D3V-112-3□4-●-△-▽
	External (M)	D3V-112M-1□4-●-△-▽	D3V-112M-2□4-●-△-▽	D3V-112M-3□4-●-△-▽
Long hinge lever 	Internal	D3V-113-1□4-●-△-▽	D3V-113-2□4-●-△-▽	D3V-113-3□4-●-△-▽
	External (M)	D3V-113M-1□4-●-△-▽	D3V-113M-2□4-●-△-▽	D3V-113M-3□4-●-△-▽
Simulated roller lever 	Internal	D3V-114-1□4-●-△-▽	D3V-114-2□4-●-△-▽	D3V-114-3□4-●-△-▽
	External (M)	D3V-114M-1□4-●-△-▽	D3V-114M-2□4-●-△-▽	D3V-114M-3□4-●-△-▽
Short hinge roller lever 	Internal	D3V-115-1□4-●-△-▽	D3V-115-2□4-●-△-▽	D3V-115-3□4-●-△-▽
	External (M)	D3V-115M-1□4-●-△-▽	D3V-115M-2□4-●-△-▽	D3V-115M-3□4-●-△-▽
Hinge roller lever 	Internal	D3V-116-1□4-●-△-▽	D3V-116-2□4-●-△-▽	D3V-116-3□4-●-△-▽
	External (M)	D3V-116M-1□4-●-△-▽	D3V-116M-2□4-●-△-▽	D3V-116M-3□4-●-△-▽

11 A (OF: 50 gf)

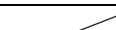
Actuator	Hinge position (far from plunger)	Contact form		
		SPDT	SPST-NC	SPST-NO
Pin plunger 	---	D3V-11G-1□3-●-△-▽	D3V-11G-2□3-●-△-▽	D3V-11G-3□3-●-△-▽
Short hinge lever 	Internal	D3V-11G1-1□3-●-△-▽	D3V-11G1-2□3-●-△-▽	D3V-11G1-3□3-●-△-▽
	External (M)	D3V-11G1M-1□3-●-△-▽	D3V-11G1M-2□3-●-△-▽	D3V-11G1M-3□3-●-△-▽
Hinge lever 	Internal	D3V-11G2-1□3-●-△-▽	D3V-11G2-2□3-●-△-▽	D3V-11G2-3□3-●-△-▽
	External (M)	D3V-11G2M-1□3-●-△-▽	D3V-11G2M-2□3-●-△-▽	D3V-11G2M-3□3-●-△-▽
Long hinge lever 	Internal	D3V-11G3-1□3-●-△-▽	D3V-11G3-2□3-●-△-▽	D3V-11G3-3□3-●-△-▽
	External (M)	D3V-11G3M-1□3-●-△-▽	D3V-11G3M-2□3-●-△-▽	D3V-11G3M-3□3-●-△-▽
Simulated roller lever 	Internal	D3V-11G4-1□3-●-△-▽	D3V-11G4-2□3-●-△-▽	D3V-11G4-3□3-●-△-▽
	External (M)	D3V-11G4M-1□3-●-△-▽	D3V-11G4M-2□3-●-△-▽	D3V-11G4M-3□3-●-△-▽
Short hinge roller lever 	Internal	D3V-11G5-1□3-●-△-▽	D3V-11G5-2□3-●-△-▽	D3V-11G5-3□3-●-△-▽
	External (M)	D3V-11G5M-1□3-●-△-▽	D3V-11G5M-2□3-●-△-▽	D3V-11G5M-3□3-●-△-▽
Hinge roller lever 	Internal	D3V-11G6-1□3-●-△-▽	D3V-11G6-2□3-●-△-▽	D3V-11G6-3□3-●-△-▽
	External (M)	D3V-11G6M-1□3-●-△-▽	D3V-11G6M-2□3-●-△-▽	D3V-11G6M-3□3-●-△-▽

6 A (OF: 100 gf)

Actuator	Hinge position (far from plunger)	Contact form		
		SPDT	SPST-NC	SPST-NO
Pin plunger 	---	D3V-6-1□4-●-△-▽	D3V-6-2□4-●-△-▽	D3V-6-3□4-●-△-▽
Short hinge lever 	Internal	D3V-61-1□4-●-△-▽	D3V-61-2□4-●-△-▽	D3V-61-3□4-●-△-▽
	External (M)	D3V-61M-1□4-●-△-▽	D3V-61M-2□4-●-△-▽	D3V-61M-3□4-●-△-▽
Hinge lever 	Internal	D3V-62-1□4-●-△-▽	D3V-62-2□4-●-△-▽	D3V-62-3□4-●-△-▽
	External (M)	D3V-62M-1□4-●-△-▽	D3V-62M-2□4-●-△-▽	D3V-62M-3□4-●-△-▽
Long hinge lever 	Internal	D3V-63-1□4-●-△-▽	D3V-63-2□4-●-△-▽	D3V-63-3□4-●-△-▽
	External (M)	D3V-63M-1□4-●-△-▽	D3V-63M-2□4-●-△-▽	D3V-63M-3□4-●-△-▽
Simulated roller lever 	Internal	D3V-64-1□4-●-△-▽	D3V-64-2□4-●-△-▽	D3V-64-3□4-●-△-▽
	External (M)	D3V-64M-1□4-●-△-▽	D3V-64M-2□4-●-△-▽	D3V-64M-3□4-●-△-▽
Short hinge roller lever 	Internal	D3V-65-1□4-●-△-▽	D3V-65-2□4-●-△-▽	D3V-65-3□4-●-△-▽
	External (M)	D3V-65M-1□4-●-△-▽	D3V-65M-2□4-●-△-▽	D3V-65M-3□4-●-△-▽
Hinge roller lever 	Internal	D3V-66-1□4-●-△-▽	D3V-66-2□4-●-△-▽	D3V-66-3□4-●-△-▽
	External (M)	D3V-66M-1□4-●-△-▽	D3V-66M-2□4-●-△-▽	D3V-66M-3□4-●-△-▽

• The □ in the model number is for the terminal code.

- A: Solder/quick-connect terminals (#187)
- C2: Quick-connect terminals (#187)
- C: Quick-connect terminals (#250)
- C6: RAST5 terminals (#250)

• The ● in the model number is for the enclosure material

- None: Standard
- T: High Temperature (200°C for D3V-6/-01, 155°C for D3V-11)
- W2: EN60695-2-11/-12 conformity with PTI=250







• The △ in the model number is for the mounting hole size.

- None: 3.1 mm
- K: 2.9 mm







• The ▽ in the model number is for the special code

- None: Standard
- H: High Temperature (125°C)
- E: Special rating of 21A (8)A (for D3V-21 only)

6 A (OF: 50 gf)

Actuator	Hinge position (far from plunger)	Contact form		
		SPDT	SPST-NC	SPST-NO
Pin plunger 	---	D3V-6G-1□3-●-Δ-▽	D3V-6G-2□3-●-Δ-▽	D3V-6G-3□3-●-Δ-▽
Short hinge lever 	Internal	D3V-6G1-1□3-●-Δ-▽	D3V-6G1-2□3-●-Δ-▽	D3V-6G1-3□3-●-Δ-▽
	External (M)	D3V-6G1M-1□3-●-Δ-▽	D3V-6G1M-2□3-●-Δ-▽	D3V-6G1M-3□3-●-Δ-▽
Hinge lever 	Internal	D3V-6G2-1□3-●-Δ-▽	D3V-6G2-2□3-●-Δ-▽	D3V-6G2-3□3-●-Δ-▽
	External (M)	D3V-6G2M-1□3-●-Δ-▽	D3V-6G2M-2□3-●-Δ-▽	D3V-6G2M-3□3-●-Δ-▽
Long hinge lever 	Internal	D3V-6G3-1□3-●-Δ-▽	D3V-6G3-2□3-●-Δ-▽	D3V-6G3-3□3-●-Δ-▽
	External (M)	D3V-6G3M-1□3-●-Δ-▽	D3V-6G3M-2□3-●-Δ-▽	D3V-6G3M-3□3-●-Δ-▽
Simulated roller lever 	Internal	D3V-6G4-1□3-●-Δ-▽	D3V-6G4-2□3-●-Δ-▽	D3V-6G4-3□3-●-Δ-▽
	External (M)	D3V-6G4M-1□3-●-Δ-▽	D3V-6G4M-2□3-●-Δ-▽	D3V-6G4M-3□3-●-Δ-▽
Short hinge roller lever 	Internal	D3V-6G5-1□3-●-Δ-▽	D3V-6G5-2□3-●-Δ-▽	D3V-6G5-3□3-●-Δ-▽
	External (M)	D3V-6G5M-1□3-●-Δ-▽	D3V-6G5M-2□3-●-Δ-▽	D3V-6G5M-3□3-●-Δ-▽
Hinge roller lever 	Internal	D3V-6G6-1□3-●-Δ-▽	D3V-6G6-2□3-●-Δ-▽	D3V-6G6-3□3-●-Δ-▽
	External (M)	D3V-6G6M-1□3-●-Δ-▽	D3V-6G6M-2□3-●-Δ-▽	D3V-6G6M-3□3-●-Δ-▽

01 A (OF: 50 gf)

Actuator	Hinge position (far from plunger)	Contact form		
		SPDT	SPST-NC	SPST-NO
Pin plunger 	---	D3V-01-1□3-●-Δ-▽	D3V-01-2□3-●-Δ-▽	D3V-01-3□3-●-Δ-▽
Short hinge lever 	Internal	D3V-011-1□3-●-Δ-▽	D3V-011-2□3-●-Δ-▽	D3V-011-3□3-●-Δ-▽
	External (M)	D3V-011M-1□3-●-Δ-▽	D3V-011M-2□3-●-Δ-▽	D3V-011M-3□3-●-Δ-▽
Hinge lever 	Internal	D3V-012-1□3-●-Δ-▽	D3V-012-2□3-●-Δ-▽	D3V-012-3□3-●-Δ-▽
	External (M)	D3V-012M-1□3-●-Δ-▽	D3V-012M-2□3-●-Δ-▽	D3V-012M-3□3-●-Δ-▽
Long hinge lever 	Internal	D3V-013-1□3-●-Δ-▽	D3V-013-2□3-●-Δ-▽	D3V-013-3□3-●-Δ-▽
	External (M)	D3V-013M-1□3-●-Δ-▽	D3V-013M-2□3-●-Δ-▽	D3V-013M-3□3-●-Δ-▽
Simulated roller lever 	Internal	D3V-014-1□3-●-Δ-▽	D3V-014-2□3-●-Δ-▽	D3V-014-3□3-●-Δ-▽
	External (M)	D3V-014M-1□3-●-Δ-▽	D3V-014M-2□3-●-Δ-▽	D3V-014M-3□3-●-Δ-▽
Short hinge roller lever 	Internal	D3V-015-1□3-●-Δ-▽	D3V-015-2□3-●-Δ-▽	D3V-015-3□3-●-Δ-▽
	External (M)	D3V-015M-1□3-●-Δ-▽	D3V-015M-2□3-●-Δ-▽	D3V-015M-3□3-●-Δ-▽
Hinge roller lever 	Internal	D3V-016-1□3-●-Δ-▽	D3V-016-2□3-●-Δ-▽	D3V-016-3□3-●-Δ-▽
	External (M)	D3V-016M-1□3-●-Δ-▽	D3V-016M-2□3-●-Δ-▽	D3V-016M-3□3-●-Δ-▽

01 A (OF: 25 gf)

Actuator	Hinge position (far from plunger)	Contact form		
		SPDT	SPST-NC	SPST-NO
Pin plunger 	---	D3V-01-1□2-●-Δ-▽	D3V-01-2□2-●-Δ-▽	D3V-01-3□2-●-Δ-▽

- The □ in the model number is for the terminal code.
 - A: Solder/quick-connect terminals (#187)
 - C2: Quick-connect terminals (#187)
 - C: Quick-connect terminals (#250)
 - C6: RAST5 terminals (#250)
- The ● in the model number is for the enclosure material
 - None: Standard
 - T: High Temperature (200°C for D3V-6/-01, 155°C for D3V-11)
 - W2: EN60695-2-11/-12 conformity with PTI=250

- The Δ in the model number is for the mounting hole size.
 - None: 3.1 mm
 - K: 2.9 mm
- The ▽ in the model number is for the special code
 - None: Standard
 - H: High Temperature (125°C)
 - E: Special rating of 21A (8)A (for D3V-21 only)

Specifications

■ Ratings

Type	Rated voltage	Non-inductive load				Inductive load			
		Resistive load		Lamp load		Inductive load		Motor load	
		NC	NO	NC	NO	NC	NO	NC	NO
D3V-21	250 VAC	21 A		3 A		12 A		4 A	
	8 VDC	21 A		5 A		12 A		7 A	
	30 VDC	14 A		5 A		12 A		5 A	
	125 VDC	0.6 A		0.1 A		0.6 A		0.1 A	
	250 VDC	0.3 A		0.05 A		0.3 A		0.05 A	
D3V-16	250 VAC	16 A		2 A		10 A		3 A	
	8 VDC	16 A		4 A		10 A		6 A	
	30 VDC	10 A		4 A		10 A		4 A	
	125 VDC	0.6 A		0.1 A		0.6 A		0.1 A	
	250 VDC	0.3 A		0.05 A		0.3 A		0.05 A	
D3V-11	250 VAC	11 A		1.5 A		6 A		2 A	
	8 VDC	11 A		3 A		6 A		3 A	
	30 VDC	6 A		3 A		6 A		3 A	
	125 VDC	0.6 A		0.1 A		0.6 A		0.1 A	
	250 VDC	0.3 A		0.05 A		0.3 A		0.05 A	
D3V-6	250 VAC	6 A		3 A		4 A		---	
	8 VDC	6 A		3 A		4 A		---	
	30 VDC	6 A		3 A		4 A		---	
	125 VDC	0.4 A		0.1 A		0.4 A		---	
	250 VDC	0.3 A		0.05 A		0.2 A		---	
D3V-01	125 VAC	0.1 A		---		---		---	
	8 VDC	0.1 A		---		---		---	
	30 VDC	0.1 A		---		---		---	

Note: 1. The above current values are the normal current values of models with a contact gap of 1 mm (gap F), which vary with the normal current values of models with a contact gap of 0.5 mm (gap G).

2. Inductive load has a power factor of 0.4 min. (AC) and a time constant of 7 ms max. (DC).
3. Lamp load has an inrush current of 10 times the steady-state current.
4. Motor load has an inrush current of 6 times the steady-state current.
5. The ratings values apply under the following test conditions: Ambient temperature: 20±2°C, Ambient humidity: 65±5%, Operating frequency: 30 operations/min

■ Approved Standards

UL1054 (File No. E41515)

CSA C22.2 No.55 (File No. LR21642)

(Only standard ratings are listed.)

Rated voltage	D3V-21G	D3V-16	D3V-16G	D3V-11	D3V-11G	D3V-6	D3V-6G	D3V-01
125 VAC	3/4 HP	16 A, 1/2 HP	16 A, 1/2 HP	11 A, 1/2 HP	11 A, 1/2 HP	6 A, 1/4 HP	6 A, 1/4 HP	0.1 A
250 VAC	20.1 A, 3/4 HP	16 A, 1/2 HP	16 A, 1/2 HP	11 A, 1/2 HP	11 A, 1/2 HP	6 A, 1/4 HP	6 A, 1/4 HP	---
125 VDC	---	0.6 A	0.1 A	0.6 A	0.1 A	---	---	---
250 VDC	---	0.3 A	---	0.3 A	---	---	---	---

EN 61058-1: 1992+A1: 1993 (License No. 119151L)

Rated voltage	D3V-21G	D3V-16	D3V-11	D3V-6	D3V-01
125 VAC	---	---	---	---	0.1 A
250 VAC	20 (4) A	16 (3) A	11 (3) A	6 (2) A	---
250 VAC	21 (8) A**				

Testing conditions: 50,000 operations, T85 (0°C to 85°C) for D3V-21/D3V-01, T105 (0°C to 105°C) for D3V-16/D3V-11/D3V-6 and T200 (0 to 200°C) for D3V-6/01 with suffix "T", T155 (0 to 155°C) for D3V-11 with suffix "T".

**Testing conditions: 10,000 operations, T85 (0°C to 85°C)

EN 60695-2-11 Ed.2, EN 60695-2-12 Ed.2 - - Glow-wire flammability test methods

Rated voltage	D3V-16	D3V-11	D3V-6	D3V-01
125 VAC	---	---	---	0.1 A
250 VAC	16 (3) A	11 (3) A	6 (2) A	---

■ Characteristics

Operating speed	0.1 mm to 1 m/s (plunger models)
Operating frequency	Mechanical: 600 operations/min Electrical: 60 operations/min
Insulation resistance	100 MΩ min. (at 500 VDC)
Contact resistance	D3V-21: 50 mΩ max. D3V-16, D3V-11, D3V-6: 30 mΩ max. D3V-01, 50 gf versions: 50 mΩ max. 25 gf versions: 100 mΩ max.
Dielectric strength (see note 2)	1,000 VAC, 50/60 Hz for 1 min between terminals of the same polarity 2,000 VAC, 50/60 Hz for 1 min between current-carrying metal parts and ground, and between each terminal and non-current-carrying metal parts
Vibration resistance (see note 3)	Malfunction: 10 to 55 Hz, 1.5-mm double amplitude
Shock resistance (see note 3)	Destruction: 400 m/s ² (approx. 40G) max. Malfunction: 100 m/s ² (approx. 10G) max.
Life expectancy	Mechanical: 10,000,000 operations min. Electrical: D3V-21: 50,000 operations min. D3V-16: 100,000 operations min. D3V-11: 200,000 operations min. D3V-6, D3V-01: 500,000 operations min.
Degree of protection	IEC IP40
Degree of protection against electric shock	Class I
Proof tracking index (PTI)	250 (High Temperature type with suffix "-T": 175)
Ambient operating temperature	D3V-21: -25°C to 85°C with no icing D3V-16: -25°C to 105°C (High Temperature type "H": -25°C to 125°C) with no icing D3V-11: -25°C to 105°C (High Temperature types "H": -25°C to 125°C, "T": -25°C to 155°C) with no icing D3V-6: -25°C to 105°C (High Temperature types "H": -25°C to 125°C, "T": -25°C to 200°C) with no icing D3V-01: -25°C to 85°C (High Temperature type "T": -25°C to 200°C) with no icing
Ambient operating humidity	85% max. (for 5°C to 35°C)
Weight	Approx. 6.2 g (plunger models)

Note: 1. Data shown are of initial value.

2. The dielectric strength values shown in the table are for models with a Separator.

3. For plunger models, the above values apply for use at both the free position and total travel position. For lever models, they apply at the total travel position.

4. For testing conditions, contact your OMRON sales representative.

■ Contact Specifications

Item		D3V-21	D3V-16	D3V-11	D3V-6	D3V-01
Contact	Specification	Rivet				Crossbar
	Material	Silver alloy				Gold alloy
	Gap (standard value)	0.5 mm	1 mm (F gap type) or 0.5 mm (G gap type)			1.0 mm
Inrush current	NC	50 A max.	40 A max.	24 A max.	15 A max.	---
	NO					
Minimum applicable load		160 mA at 5 VDC				1 mA at 5 VDC

Note: Minimum applicable loads are indicated by N standard reference values. This value represents the failure rate at a 60% (λ_{60}) reliability level (JIS C5003). The equation $\lambda_{60}=0.5 \times 10^{-6} / \text{operations}$ indicates that a failure rate of 1/2,000,000 operations can be expected at a reliability level of 60%.

■ Contact Form

SPDT	SPST-NC	SPST-NO
		

Dimensions

■ Terminals

Note: Unless otherwise specified, all units are in millimeters and a tolerance of ± 0.4 mm applies to all dimensions

Terminal type	Solder Terminal (A)	Quick-connect Terminal (#187) (C2)	Quick-connect Terminal (#250) (C)	Quick-connect RAST5 Terminals (#250)(C6)
COM				
Terminal dimensions				

Note: The table above is for the SPDT contact specifications. Two terminals will be available for SPST-NO or SPST-NC contact specifications. For terminal positions, refer to the above *Contact Form*.

■ Mounting Holes

All switches may be panel mounted using M3 mounting screws with plane washers or spring washers to securely mount the switch. Tighten the screws to a torque of 0.39 to 0.59 N·m.



■ Dimensions and Operating Characteristics

- Note:**
- Unless otherwise specified, all units are in millimeters and a tolerance of ± 0.4 mm applies to all dimensions
 - The following illustrations and drawings are for quick-connect terminals (#187) (terminals C2). D3V models also incorporate terminals A, C, and C6, which are omitted from the following drawings. Refer to *Terminals* section for the dimensions of these terminals.
 - The □ in the model number is for the terminal code.
 - The Δ in the model number is for combinations of the enclosure material, the mounting hole size and the special code as indicated in the *Model Number Legend* and *Available Combinations* tables. The hole size in the following illustrations of models with a suffix "K" in the Δ is 2.9 mm.
 - The operating characteristics are for operation in the A direction (↓).

Plunger Models

- D3V-21G-1□4A-Δ
- D3V-16-1□5-Δ
- D3V-11-1□5-Δ
- D3V-11-1□4-Δ
- D3V-6-1□4-Δ
- D3V-6G-1□3-Δ
- D3V-01-1□2-Δ
- D3V-01-1□3-Δ



Model	D3V-21G-1□4A-Δ	D3V-16-1□5-Δ D3V-11-1□5-Δ	D3V-11-1□4-Δ D3V-6-1□4-Δ	D3V-6G-1□3-Δ	D3V-01-1□3-Δ	D3V-01-1□2-Δ
OF max.	125 gf	200 gf	100 gf	50 gf	50 gf	25 gf
RF min.	20 gf	50 gf	15 gf	5 gf	5 gf	3 gf
PT max.	1.2 mm	1.2 mm			1.2 mm	
OT min.	1.0 mm	1.0 mm			1.0 mm	
MD max.	0.3 mm	0.4 mm (F gap type) or 0.3 mm (G gap type)			0.4 mm	
OP	14.7±0.4 mm					

Short Hinge Lever Models

- D3V-21G1-1□4A-Δ
- D3V-161-1□5-Δ
- D3V-111-1□5-Δ
- D3V-111-1□4-Δ
- D3V-61-1□4-Δ
- D3V-6G1-1□3-Δ
- D3V-011-1□3-Δ



- D3V-21G1M-1□4A-Δ
- D3V-161M-1□5-Δ
- D3V-111M-1□5-Δ
- D3V-111M-1□4-Δ
- D3V-61M-1□4-Δ
- D3V-6G1M-1□3-Δ
- D3V-011M-1□3-Δ



Model	D3V-21G1(M)-1□4A-Δ	D3V-161(M)-1□5-Δ D3V-111(M)-1□5-Δ	D3V-111(M)-1□4-Δ D3V-61(M)-1□4-Δ	D3V-6G1(M)-1□3-Δ	D3V-011(M)-1□3-Δ
OF max.	125 gf	200 gf	100 gf	50 gf	
RF min.	20 gf	50 gf	15 gf	5 gf	
PT max.	1.6 mm	1.6 mm			1.6 mm
OT min.	0.8 mm	0.8 mm			0.8 mm
MD max.	0.5 mm	0.6 mm (F gap type) or 0.5 mm (G gap type)			0.6 mm
OP	15.2 ± 0.5 mm				

- D3V-21G1K-1□4A-Δ
- D3V-161K-1□5-Δ
- D3V-111K-1□5-Δ
- D3V-111K-1□4-Δ
- D3V-61K-1□4-Δ
- D3V-6G1K-1□3-Δ
- D3V-011K-1□3-Δ



Model	D3V-21G1K-1□4A-Δ	D3V-161K-1□5-Δ D3V-111K-1□5-Δ	D3V-111K-1□4-Δ D3V-61K-1□4-Δ	D3V-6G1K-1□3-Δ	D3V-011K-1□3-Δ
OF max.	85 gf	130 gf	65 gf	35 gf	
RF min.	8 gf	16 gf	8 gf	4 gf	
PT max.	3.5 mm	3.5 mm			3.5 mm
OT min.	1.1 mm	1.1 mm			1.1 mm
MD max.	1.1 mm	1.2 mm (F gap type) or 1.1 mm (G gap type)			1.2 mm
OP	15.2 ± 1.2 mm				

Hinge Lever Models

- D3V-21G2-1□4A-Δ
- D3V-162-1□5-Δ
- D3V-112-1□5-Δ
- D3V-112-1□4-Δ
- D3V-62-1□4-Δ
- D3V-6G2-1□3-Δ
- D3V-012-1□3-Δ



- D3V-21G2M-1□4A-Δ
- D3V-162M-1□5-Δ
- D3V-112M-1□5-Δ
- D3V-112M-1□4-Δ
- D3V-62M-1□4-Δ
- D3V-6G2M-1□3-Δ
- D3V-012M-1□3-Δ



Model	D3V-21G2(M)-1□4A-Δ	D3V-162(M)-1□5-Δ D3V-112(M)-1□5-Δ	D3V-112(M)-1□4-Δ D3V-62(M)-1□4-Δ	D3V-6G2(M)-1□3-Δ	D3V-012(M)-1□3-Δ
OF max.	80 gf	125 gf	60 gf		30 gf
RF min.	6 gf	14 gf	6 gf		---
PT max.	4.0 mm	4.0 mm		4.0 mm	
OT min.	1.6 mm	1.6 mm		1.6 mm	
MD max.	0.8 mm	1.5 mm (F gap type) or 0.8 mm (G gap type)			1.5 mm
OP	15.2 ± 1.2 mm				

- D3V-21G2K-1□4A-Δ
- D3V-162K-1□5-Δ
- D3V-112K-1□5-Δ
- D3V-112K-1□4-Δ
- D3V-62K-1□4-Δ
- D3V-6G2K-1□3-Δ
- D3V-012K-1□3-Δ



Model	D3V-21G2K-1□4A-Δ	D3V-162K-1□5-Δ D3V-112K-1□5-Δ	D3V-112K-1□4-Δ D3V-62K-1□4-Δ	D3V-6G2K-1□3-Δ	D3V-012K-1□3-Δ
OF max.	45 gf	70 gf	35 gf	20 gf	
RF min.	4 gf	8 gf	4 gf	---	
PT max.	6.0 mm	6.0 mm		6.0 mm	
OT min.	2.5 mm	2.5 mm		2.5 mm	
MD max.	1.3 mm	2.0 mm (F gap type) or 1.3 mm (G gap type)			2.0 mm
OP	15.2 ± 2.0 mm				

Long Hinge Lever Models

- D3V-21G3-1□4A-Δ
- D3V-163-1□5-Δ
- D3V-113-1□5-Δ
- D3V-113-1□4-Δ
- D3V-63-1□4-Δ
- D3V-6G3-1□3-Δ
- D3V-013-1□3-Δ



- D3V-21G3M-1□4A-Δ
- D3V-163M-1□5-Δ
- D3V-113M-1□5-Δ
- D3V-113M-1□4-Δ
- D3V-63M-1□4-Δ
- D3V-6G3M-1□3-Δ
- D3V-013M-1□3-Δ



Model	D3V-21G3(M)-1□4A-Δ	D3V-163(M)-1□5-Δ D3V-113(M)-1□5-Δ	D3V-113(M)-1□4-Δ D3V-63(M)-1□4-Δ	D3V-6G3(M)-1□3-Δ	D3V-013(M)-1□3-Δ
OF max.	45 gf	70 gf	35 gf	20 gf	
RF min.	3 gf	6 gf	---	---	
PT max.	9.0 mm	9.0 mm	9.0 mm		9.0 mm
OT min.	2.0 mm	2.0 mm	3.2 mm		3.2 mm
MD max.	2.0 mm	2.8 mm (F gap type) or 2.0 mm (G gap type)		2.8 mm (F gap type) or 2.0 mm (G gap type)	
OP	15.2 ^{+2.6} / _{-3.2} mm		15.2 ± 2.6 mm		

- D3V-21G3K-1□4A-Δ
- D3V-163K-1□5-Δ
- D3V-113K-1□5-Δ
- D3V-113K-1□4-Δ
- D3V-63K-1□4-Δ
- D3V-6G3K-1□3-Δ
- D3V-013K-1□3-Δ



Model	D3V-21G3K-1□4A-Δ	D3V-163K-1□5-Δ D3V-113K-1□5-Δ	D3V-113K-1□4-Δ D3V-63K-1□4-Δ	D3V-6G3K-1□3-Δ	D3V-013K-1□3-Δ
OF max.	20 gf	35 gf	20 gf	10 gf	
RF min.	---	4 gf	---	---	
PT max.	15.0 mm	15.0 mm			15.0 mm
OT min.	4.0 mm	4.0 mm			4.0 mm
MD max.	3.0 mm	3.8 mm (F gap type) or 3.0 mm (G gap type)			3.8 mm
OP	15.2 ± 3.0 mm				

Simulated Roller Lever Models

- D3V-21G4-1□4A-Δ
- D3V-164-1□5-Δ
- D3V-114-1□5-Δ
- D3V-114-1□4-Δ
- D3V-64-1□4-Δ
- D3V-6G4-1□3-Δ
- D3V-014-1□3-Δ

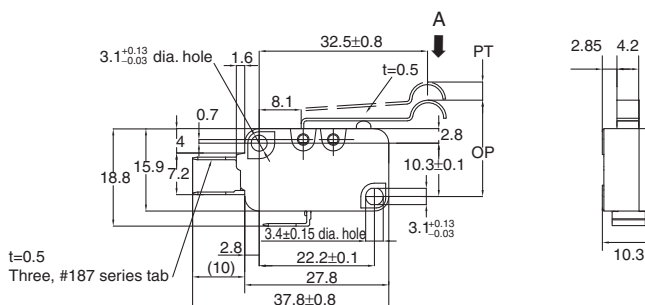
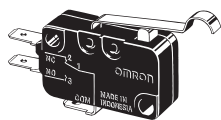

- D3V-21G4M-1□4A-Δ
- D3V-164M-1□5-Δ
- D3V-114M-1□5-Δ
- D3V-114M-1□4-Δ
- D3V-64M-1□4-Δ
- D3V-6G4M-1□3-Δ
- D3V-014M-1□3-Δ

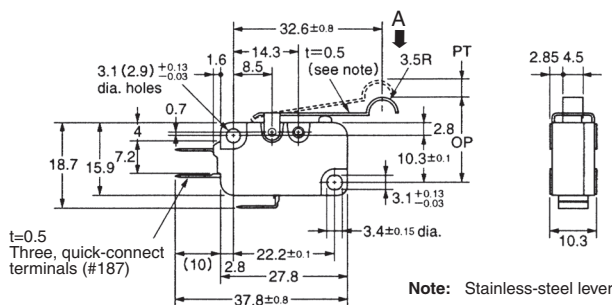

Model	D3V-21G4(M)-1□4A-Δ	D3V-164(M)-1□5-Δ D3V-114(M)-1□5-Δ	D3V-114(M)-1□4-Δ D3V-64(M)-1□4-Δ	D3V-6G4(M)-1□3-Δ	D3V-014(M)-1□3-Δ
OF max.	85 gf	125 gf	60 gf	30 gf	
RF min.	7 gf	14 gf	6 gf	---	
PT max.	4.0 mm	4.0 mm			4.0 mm
OT min.	1.6 mm	1.6 mm			1.6 mm
MD max.	1.4 mm	1.5 mm (F gap type) or 0.8 mm (G gap type)			1.5 mm
OP	18.7 ± 1.2 mm				

- D3V-21G4K-1□4A-Δ
- D3V-164K-1□5-Δ
- D3V-114K-1□5-Δ
- D3V-114K-1□4-Δ
- D3V-64K-1□4-Δ
- D3V-6G4K-1□3-Δ
- D3V-014K-1□3-Δ

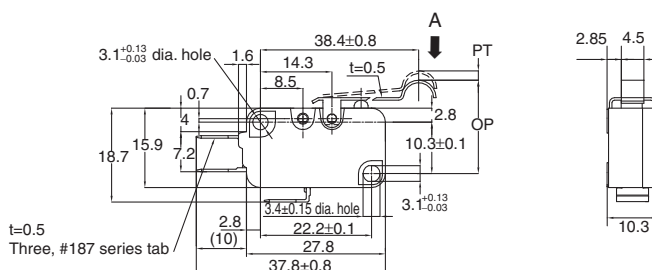
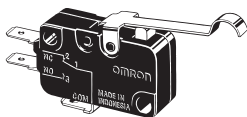

Model	D3V-21G4K-1□4A-Δ	D3V-164K-1□5-Δ D3V-114K-1□5-Δ	D3V-114K-1□4-Δ D3V-64K-1□4-Δ	D3V-6G4K-1□3-Δ	D3V-014K-1□3-Δ
OF max.	55 gf	75 gf	40 gf	20 gf	
RF min.	3 gf	10 gf	3 gf	---	
PT max.	8.0 mm	8.0 mm			8.0 mm
OT min.	1.5 mm	1.5 mm			1.5 mm
MD max.	3.0 mm	3.5 mm (F gap type) or 3.0 mm (G gap type)			3.5 mm
OP	18.7 ± 1.2 mm				

Short Hinge Roller Lever Models

- D3V-21G5-1□4A-Δ
- D3V-165-1□5-Δ
- D3V-115-1□5-Δ
- D3V-115-1□4-Δ
- D3V-65-1□4-Δ
- D3V-6G5-1□3-Δ
- D3V-015-1□3-Δ



- D3V-21G5M-1□4A-Δ
- D3V-165M-1□5-Δ
- D3V-115M-1□5-Δ
- D3V-115M-1□4-Δ
- D3V-65M-1□4-Δ
- D3V-6G5M-1□3-Δ
- D3V-015M-1□3-Δ

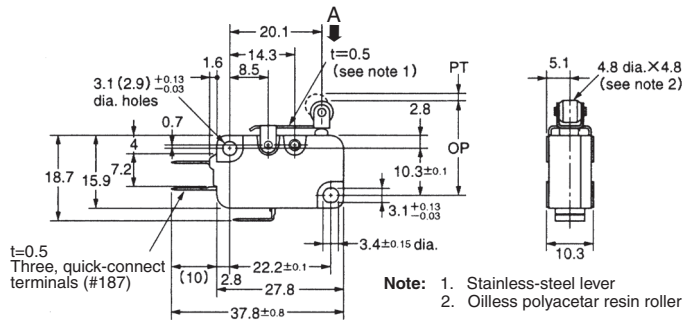

Model	D3V-21G5(M)-1□4A-Δ	D3V-165(M)-1□5-Δ D3V-115(M)-1□5-Δ	D3V-115(M)-1□4-Δ D3V-65(M)-1□4-Δ	D3V-6G5(M)-1□3-Δ	D3V-015(M)-1□3-Δ
OF max. RF min.	145 gf 20 gf	240 gf 50 gf	120 gf 15 gf		60 gf 6 gf
PT max. OT min. MD max.	1.6 mm 0.8 mm 0.5 mm	1.6 mm 0.8 mm 0.6 mm (F gap type) or 0.5 mm (G gap type)			1.6 mm 0.8 mm 0.6 mm
OP	20.7±0.6 mm				

- D3V-21G5K-1□4A-Δ
- D3V-165K-1□5-Δ
- D3V-115K-1□5-Δ
- D3V-115K-1□4-Δ
- D3V-65K-1□4-Δ
- D3V-6G5K-1□3-Δ
- D3V-015K-1□3-Δ

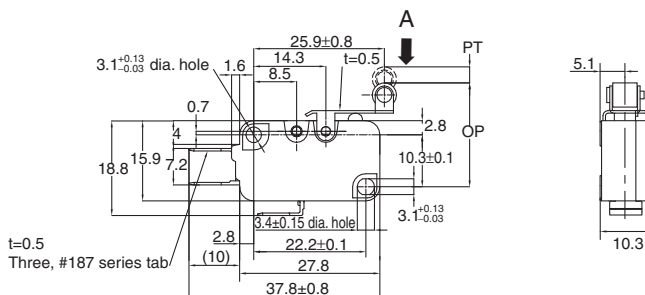

Model	D3V-21G5K-1□4A-Δ	D3V-165K-1□5-Δ D3V-115K-1□5-Δ	D3V-115K-1□4-Δ D3V-65K-1□4-Δ	D3V-6G5K-1□3-Δ	D3V-015K-1□3-Δ
OF max. RF min.	100 gf 8 gf	160 gf 15 gf	80 gf 8 gf		40 gf 4 gf
PT max. OT min. MD max.	2.6 mm 1.0 mm 8.0 mm	2.6 mm 1.0 mm 0.9 mm (F gap type) or 0.8 mm (G gap type)			2.6 mm 1.0 mm 0.9 mm
OP	20.7 ± 1.0 mm				

Hinge Roller Lever Models

- D3V-21G6-1□4A-Δ
- D3V-166-1□5-Δ
- D3V-116-1□5-Δ
- D3V-116-1□4-Δ
- D3V-66-1□4-Δ
- D3V-6G6-1□3-Δ
- D3V-016-1□3-Δ



- D3V-21G6M-1□4A-Δ
- D3V-166M-1□5-Δ
- D3V-116M-1□5-Δ
- D3V-116M-1□4-Δ
- D3V-66M-1□4-Δ
- D3V-6G6M-1□3-Δ
- D3V-016M-1□3-Δ



Model	D3V-21G6(M)-1□4A-Δ	D3V-166(M)-1□5-Δ D3V-116(M)-1□5-Δ	D3V-116(M)-1□4-Δ D3V-66(M)-1□4-Δ	D3V-6G6(M)-1□3-Δ	D3V-016(M)-1□3-Δ
OF max. RF min.	80 gf 5 gf	125 gf 14 gf	60 gf 6 gf	30 gf ---	
PT max. OT min. MD max.	4.0 mm 1.6 mm 0.8 mm	4.0 mm 1.6 mm 1.5 mm (F gap type) or 0.8 mm (G gap type)			4.0 mm 1.6 mm 1.5 mm
OP	20.7±1.2 mm				

- D3V-21G6K-1□4A-Δ
- D3V-166K-1□5-Δ
- D3V-116K-1□5-Δ
- D3V-116K-1□4-Δ
- D3V-66K-1□4-Δ
- D3V-6G6K-1□3-Δ
- D3V-016K-1□3-Δ



Model	D3V-21G6K-1□4A-Δ	D3V-166K-1□5-Δ D3V-116K-1□5-Δ	D3V-116K-1□4-Δ D3V-66K-1□4-Δ	D3V-6G6K-1□3-Δ	D3V-016K-1□3-Δ
OF max. RF min.	50 gf 3 gf	75 gf 10 gf	40 gf 3 gf	20 gf ---	
PT max. OT min. MD max.	7.2 mm 2.0 mm 2.0 mm	7.2 mm 2.0 mm 2.7 mm (F gap type) or 2.0 mm (G gap type)			7.2 mm 2.0 mm 2.7 mm
OP	20.7 ± 2.2 mm				

Precautions

Be sure to read the precautions and information common to all Snap Action and Detection Switches, contained in the Technical User's Guide, "Snap Action Switches, Technical Information" for correct use.

■ Correct Use

Mounting Direction

Mount lever-operated switches with a maximum operating force of 0.49 N in a direction where the actuator weight will not be applied to the switch. Since the switch is designed for a small load, its resetting force is small. Therefore, resetting failure may occur if unnecessary load is applied to the switch.

Insulation Distance

According to EN61058-1, the minimum insulation thickness for this switch should be 1.1 mm and minimum clearance distance between the terminal and mounting plate should be 1.9 mm. If the insulation distance cannot be provided in the product incorporating the switch, either use a switch with insulation barrier or use a Separator to ensure sufficient insulation distance.

Using Microloads

Using a model for ordinary loads to switch microloads may result in faulty operation. Instead, use the models that are designed for microloads and that operate in the following range;



However, even when using microload models within the operating range shown above, if inrush current or inductive voltage spikes occur when the contact is opened or closed, then contact wear may increase and so decrease the service life. Therefore, insert a contact protection circuit where necessary.

Solder Terminal Approval Conditions

Use of soldering iron for normal soldering is acceptable. Soldering hook holes version available.
Soldering terminal types 1 and 2 are met.

■ Cautions

Handling

Be careful not to drop the switch. Doing so may cause damage to the switch's internal components because it is designed for a small load.

MEMO

A large grid of dashed lines for writing notes, consisting of 20 columns and 30 rows of small squares.

Omron Electronic Components, LLC

Terms and Conditions of Sales

I. GENERAL

- Definitions:** The words used herein are defined as follows.
 - Terms:** These terms and conditions
 - Seller:** Omron Electronic Components LLC and its subsidiaries
 - Buyer:** The buyer of Products, including any end user in section III through VI
 - Products:** Products and/or services of Seller
 - Including:** Including without limitation
- Offer; Acceptance:** These Terms are deemed part of all quotations, acknowledgments, invoices, purchase orders and other documents, whether electronic or in writing, relating to the sale of Products by Seller. Seller hereby objects to any Terms proposed in Buyer's purchase order or other documents which are inconsistent with, or in addition to, these Terms.
- Distributor:** Any distributor shall inform its customer of the contents after and including section III of these Terms.

II. SALES

- Prices; Payment:** All prices stated are current, subject to change without notice by Seller. Buyer agrees to pay the price in effect at the time the purchase order is accepted by Seller. Payments for Products received are due net 30 days unless otherwise stated in the invoice. Buyer shall have no right to set off any amounts against the amount owing in respect of this invoice.
- Discounts:** Cash discounts, if any, will apply only on the net amount of invoices sent to Buyer after deducting transportation charges, taxes and duties, and will be allowed only if (a) the invoice is paid according to Seller's payment terms and (b) Buyer has no past due amounts owing to Seller.
- Interest:** Seller, at its option, may charge Buyer 1.5% interest per month or the maximum legal rate, whichever is less, on any balance not paid within the stated terms.
- Orders:** Seller will accept no order less than 200 U.S. dollars net billing.
- Currencies:** If the prices quoted herein are in a currency other than U.S. dollars, Buyer shall make remittance to Seller at the then current exchange rate most favorable to Seller; provided that if remittance is not made when due, Buyer will convert the amount to U.S. dollars at the then current exchange rate most favorable to Seller available during the period between the due date and the date remittance is actually made.
- Governmental Approvals:** Buyer shall be responsible for all costs involved in obtaining any government approvals regarding the importation or sale of the Products.
- Taxes:** All taxes, duties and other governmental charges (other than general real property and income taxes), including any interest or penalties thereon, imposed directly or indirectly on Seller or required to be collected directly or indirectly by Seller for the manufacture, production, sale, delivery, importation, consumption or use of the Products sold hereunder (including customs duties and sales, excise, use, turnover and license taxes) shall be charged to and remitted by Buyer to Seller.
- Financial:** If the financial position of Buyer at any time becomes unsatisfactory to Seller, Seller reserves the right to stop shipments or require satisfactory security or payment in advance. If Buyer fails to make payment or otherwise comply with these Terms or any related agreement, Seller may (without liability and in addition to other remedies) cancel any unshipped portion of Products sold hereunder and stop any Products in transit until Buyer pays all amounts, including amounts payable hereunder, whether or not then due, which are owing to it by Buyer. Buyer shall in any event remain liable for all unpaid accounts.
- Cancellation; Etc:** Orders are not subject to rescheduling or cancellation unless Buyer indemnifies Seller fully against all costs or expenses arising in connection therewith.
- Force Majeure:** Seller shall not be liable for any delay or failure in delivery resulting from causes beyond its control, including earthquakes, fires, floods, strikes or other labor disputes, shortage of labor or materials, accidents to machinery, acts of sabotage, riots, delay in or lack of transportation or the requirements of any government authority.
- Shipping; Delivery:** Unless otherwise expressly agreed in writing by Seller:
 - All sales and shipments of Products shall be FOB shipping point (unless otherwise stated in writing by Seller), at which point title to and all risk of loss of the Products shall pass from Seller to Buyer, provided that Seller shall retain a security interest in the Products until the full purchase price is paid by Buyer;
 - Delivery and shipping dates are estimates only; and
 - Seller will package Products as it deems proper for protection against normal handling and extra charges apply to special conditions.
- Claims:** Any claim by Buyer against Seller for shortage or damage to the Products occurring before delivery to the carrier or any claim related to pricing or other charges must be presented in detail in writing to Seller within 30 days of receipt of shipment.

III. PRECAUTIONS

- Suitability:** IT IS THE BUYER'S SOLE RESPONSIBILITY TO ENSURE THAT ANY OMRON PRODUCT IS FIT AND SUFFICIENT FOR USE IN A MOTORIZED VEHICLE APPLICATION. BUYER SHALL BE SOLELY RESPONSIBLE FOR DETERMINING APPROPRIATENESS OF THE PARTICULAR PRODUCT WITH RESPECT TO THE BUYER'S APPLICATION INCLUDING (A) ELECTRICAL OR ELECTRONIC COMPONENTS, (B) CIRCUITS, (C) SYSTEM ASSEMBLIES, (D) END PRODUCT, (E) SYSTEM, (F) MATERIALS OR SUBSTANCES OR (G) OPERATING ENVIRONMENT. Buyer acknowledges that it alone has determined that the Products will meet their requirements of the intended use in all cases. Buyer must know and observe all prohibitions of use applicable to the Product/s.
- Use with Attention:** The followings are some examples of applications for which particular attention must be given. This is not intended to be an exhaustive list of all possible use of any Product, nor to imply that any use listed may be suitable for any Product:
 - Outdoor use, use involving potential chemical contamination or electrical interference.

- Use in consumer Products or any use in significant quantities.
 - Energy control systems, combustion systems, railroad systems, aviation systems, medical equipment, amusement machines, vehicles, safety equipment, and installations subject to separate industry or government regulations.
 - Systems, machines, and equipment that could present a risk to life or property.
- Prohibited Use:** NEVER USE THE PRODUCT FOR AN APPLICATION INVOLVING SERIOUS RISK TO LIFE OR PROPERTY WITHOUT ENSURING THAT THE SYSTEM AS A WHOLE HAS BEEN DESIGNED TO ADDRESS THE RISKS, AND THAT THE PRODUCT IS PROPERLY RATED AND INSTALLED FOR THE INTENDED USE WITHIN THE OVERALL EQUIPMENT OR SYSTEM.
 - Motorized Vehicle Application:** USE OF ANY PRODUCT/S FOR A MOTORIZED VEHICLE APPLICATION MUST BE EXPRESSLY STATED IN THE SPECIFICATION BY SELLER.
 - Programmable Products:** Seller shall not be responsible for the Buyer's programming of a programmable Product.

IV. WARRANTY AND LIMITATION

- Warranty:** Seller's exclusive warranty is that the Products will be free from defects in materials and workmanship for a period of twelve months from the date of sale by Seller (or such other period expressed in writing by Seller). SELLER MAKES NO WARRANTY OR REPRESENTATION, EXPRESS OR IMPLIED, ABOUT ALL OTHER WARRANTIES, NON-INFRINGEMENT, MERCHANTABILITY OR FITNESS FOR A PARTICULAR PURPOSE OF THE PRODUCTS.
- Buyer Remedy:** Seller's sole obligation hereunder shall be to replace (in the form originally shipped with Buyer responsible for labor charges for removal or replacement thereof) the non-complying Product or, at Seller's election, to repay or credit Buyer an amount equal to the purchase price of the Product; provided that there shall be no liability for Seller or its affiliates unless Seller's analysis confirms that the Products were correctly handled, stored, installed and maintained and not subject to contamination, abuse, misuse or inappropriate modification. Return of any Products by Buyer must be approved in writing by Seller before shipment.
- Limitation on Liability:** SELLER AND ITS AFFILIATES SHALL NOT BE LIABLE FOR SPECIAL, INDIRECT, INCIDENTAL OR CONSEQUENTIAL DAMAGES, LOSS OF PROFITS OR PRODUCTION OR COMMERCIAL LOSS IN ANY WAY CONNECTED WITH THE PRODUCTS, WHETHER SUCH CLAIM IS BASED IN CONTRACT, WARRANTY, NEGLIGENCE OR STRICT LIABILITY. FURTHER, IN NO EVENT SHALL LIABILITY OF SELLER OR ITS AFFILIATES EXCEED THE INDIVIDUAL PRICE OF THE PRODUCT ON WHICH LIABILITY IS ASSERTED.
- Indemnities:** Buyer shall indemnify and hold harmless Seller, its affiliates and its employees from and against all liabilities, losses, claims, costs and expenses (including attorney's fees and expenses) related to any claim, investigation, litigation or proceeding (whether or not Seller is a party) which arises or is alleged to arise from Buyer's acts or omissions under these Terms or in any way with respect to the Products.

V. INFORMATION; ETC.

- Intellectual Property:** The intellectual property embodied in the Products is the exclusive property of Seller and its affiliates and Buyer shall not attempt to duplicate it in any way without the written permission of Seller. Buyer (at its own expense) shall indemnify and hold harmless Seller and defend or settle any action brought against Seller to the extent that it is based on a claim that any Product made to Buyer specifications infringed intellectual property rights of another party.
- Property; Confidentiality:** Notwithstanding any charges to Buyer for engineering or tooling, all engineering and tooling shall remain the exclusive property of Seller. All information and materials supplied by Seller to Buyer relating to the Products are confidential and proprietary, and Buyer shall limit distribution thereof to its trusted employees and strictly prevent disclosure to any third party.
- Performance Data:** Performance data is provided as a guide in determining suitability and does not constitute a warranty. It may represent the result of Seller's test conditions, and the users must correlate it to actual application requirements.
- Change In Specifications:** Product specifications and descriptions may be changed at any time based on improvements or other reasons. It is Seller's practice to change part numbers when published ratings or features are changed, or when significant engineering changes are made. However, some specifications of the Product may be changed without any notice.
- Errors And Omissions:** The information on Seller's website or in other documentation has been carefully checked and is believed to be accurate; however, no responsibility is assumed for clerical, typographical or proofreading errors or omissions.
- Export Controls:** Buyer shall comply with all applicable laws, regulations and licenses regarding (a) export of the Products or information provided by Seller; (b) sale of Products to forbidden or other proscribed persons or organizations; (c) disclosure to non-citizens of regulated technology or information.

VI. MISCELLANEOUS

- Waiver:** No failure or delay by Seller in exercising any right and no course of dealing between Buyer and Seller shall operate as a waiver of rights by Seller.
- Assignment:** Buyer may not assign its rights hereunder without Seller's written consent.
- Law:** These Terms are governed by Illinois law (without regard to conflict of laws). Federal and state courts in Cook County, Illinois have exclusive jurisdiction for any dispute hereunder.
- Amendment:** These Terms constitute the entire agreement between Buyer and Seller relating to the Products, and no provision may be changed or waived unless in writing signed by the parties.
- Severability:** If any provision hereof is rendered ineffective or invalid, such provision shall not invalidate any other provision.

Certain Precautions on Specifications and Use

1. **Suitability for Use.** Seller shall not be responsible for conformity with any standards, codes or regulations which apply to the combination of the Product in Buyer's application or use of the Product. At Buyer's request, Seller will provide applicable third party certification documents identifying ratings and limitations of use which apply to the Product. This information by itself is not sufficient for a complete determination of the suitability of the Product in combination with the end product, machine, system, or other application or use. Buyer shall be solely responsible for determining appropriateness of the particular Product with respect to Buyer's application, product or system. Buyer shall take application responsibility in all cases but the following is a non-exhaustive list of applications for which particular attention must be given:
 - (i) Outdoor use, uses involving potential chemical contamination or electrical interference, or conditions or uses not described in this document.
 - (ii) Energy control systems, combustion systems, railroad systems, aviation systems, medical equipment, amusement machines, vehicles, safety equipment, and installations subject to separate industry or government regulations.
 - (iii) Use in consumer products or any use in significant quantities.
 - (iv) Systems, machines and equipment that could present a risk to life or property. Please know and observe all prohibitions of use applicable to this product.

NEVER USE THE PRODUCT FOR AN APPLICATION INVOLVING SERIOUS RISK TO LIFE OR PROPERTY WITHOUT ENSURING THAT THE SYSTEM AS A WHOLE HAS BEEN DESIGNED TO ADDRESS THE RISKS, AND THAT THE OMRON PRODUCT IS PROPERLY RATED AND INSTALLED FOR THE INTENDED USE WITHIN THE OVERALL EQUIPMENT OR SYSTEM.
2. **Programmable Products.** Seller shall not be responsible for the user's programming of a programmable product, or any consequence thereof.
3. **Performance Data.** Performance data given in this publication is provided as a guide for the user in determining suitability and does not constitute a warranty. It may represent the result of Seller's test conditions, and the users must correlate it to actual application requirements. Actual performance is subject to Seller's Warranty and Limitations of Liability.
4. **Change in Specifications.** Product specifications and accessories may be changed at any time based on improvements and other reasons. It is our practice to change part numbers when published ratings or features are changed, or when significant construction changes are made. However, some specifications of the Product may be changed without any notice. When in doubt, special part numbers may be assigned to fix or establish key specifications for your application. Please consult with your Seller representative at any time to confirm actual specifications of purchased Product.
5. **Errors and Omissions.** The information in this publication has been carefully checked and is believed to be accurate; however, no responsibility is assumed for clerical, typographical or proofreading errors, or omissions.
6. **RoHS Compliance.** Where indicated, our products currently comply, to the best of our knowledge as of the date of this publication, with the requirements of the European Union's Directive on the Restriction of certain Hazardous Substances ("RoHS"), although the requirements of RoHS do not take effect until July 2006. These requirements may be subject to change. Please consult our website for current information.

Complete "Terms and Conditions of Sale" for product purchase and use are on Omron's website at <http://www.components.omron.com> – under the "About Us" tab, in the Legal Matters section.

ALL DIMENSIONS SHOWN ARE IN MILLIMETERS.

To convert millimeters into inches, multiply by 0.03937. To convert grams into ounces, multiply by 0.03527.

OMRON®

**OMRON ELECTRONIC
COMPONENTS LLC**

55 E. Commerce Drive, Suite B
Schaumburg, IL 60173

847-882-2288

OMRON ON-LINE

Global - <http://www.omron.com>

USA - <http://www.components.omron.com>