

**Series 210 - side view**

**IR high intensity 880 nm**

**Features**

- for application mounting in side view
- size 1008: 3,0(L) x 1,8(W) x 1,0(H) mm
- circuit substrate: glass laminated epoxy
- devices are ROHS conform
- lead free solderable, soldering pads: gold plated
- taped in 8 mm blister tape, cathode to transporting perforation
- all devices sorted into luminous intensity classes
- high radiation intensity type



**Absolute Maximum Ratings**

$I_{F, max}$ [mA]	$I_{F, P}$ [mA] $t_p \leq 100 \mu s$ $\tau=1: 10$	$V_R$ [V]	$I_{R, max}$ [ $\mu A$ ]	Thermal resistance $R_{thJA}$ [K / W]	$T_{Op}$ [ $^{\circ}C$ ]	$T_{St}$ [ $^{\circ}C$ ]
50	250	5	100	500	-40...85	-55...85

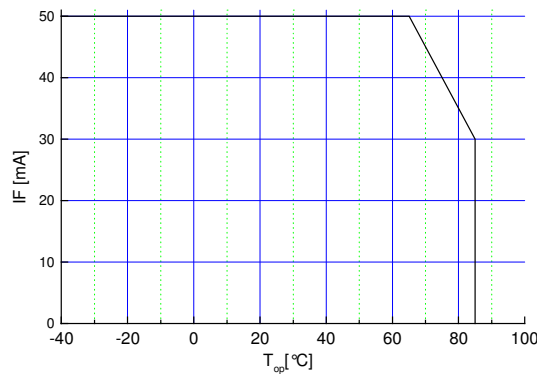

Maximal forward current (DC) characteristic

**Electro-Optical Characteristics**

Type	Marking at	Measurement $I_F$ [mA]	Switching time (rise & fall)		$V_F$ [V]		$\lambda_p$ [nm]	$I_e$ [mW/sr]	
			typ [ns]	max [ns]	typ	max		min	typ
OIS-210 880	cathode	50	20	80	1,4	1,7	$875 \pm 15$	1.2	2.5

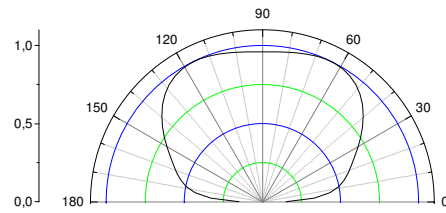

view angle

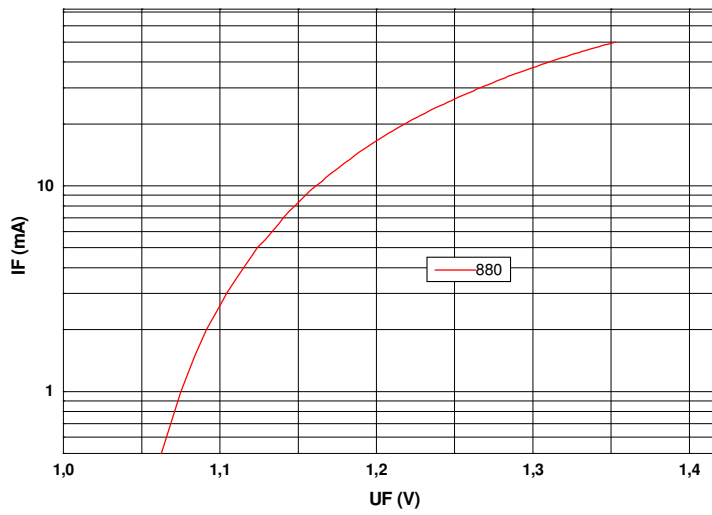

$U_F - I_F$   
characteristic

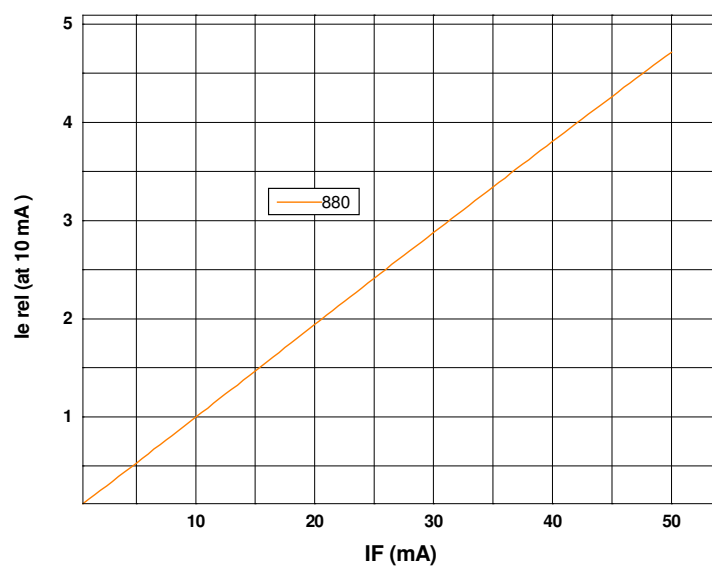

$I_F - I_{e,rel}$   
characteristic

**Outline Drawing**

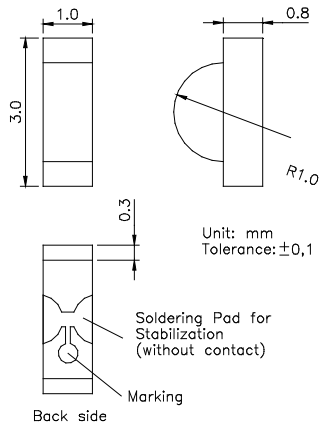

**Recommended Soldering Patterns**

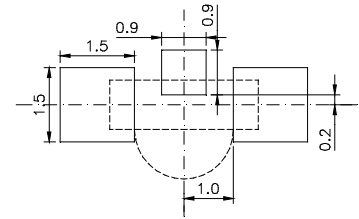

**Soldering Conditions**

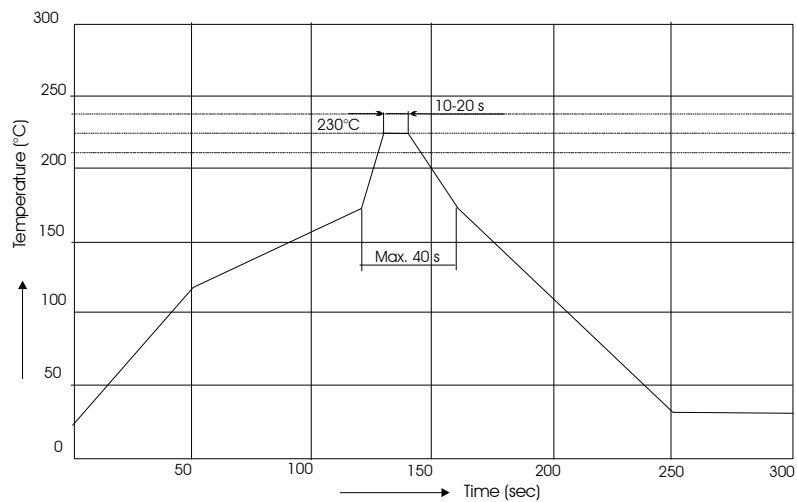

IR reflow soldering profile

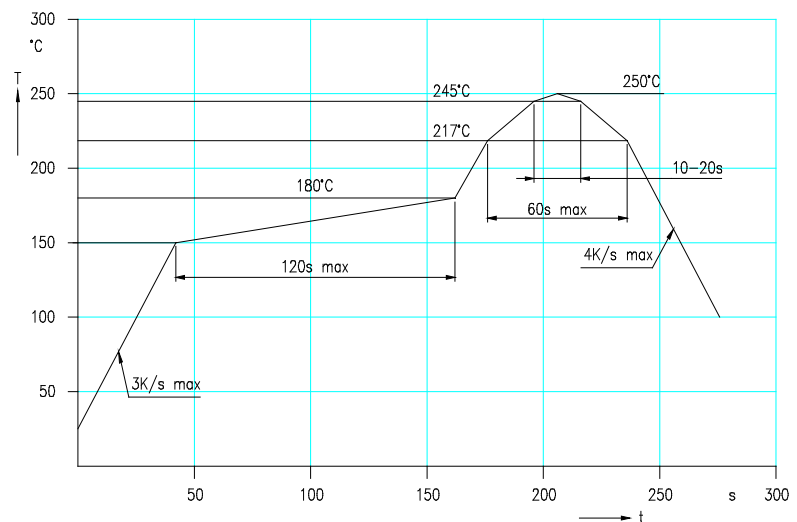

IR reflow soldering profile for lead free soldering

Manual soldering: max power of iron 25W/ 3s/ 300°C

## Ordering Code For Parts

<u>Series</u>	<u>Color</u>	<u>Encapsulation</u>	<u>Packaging</u>
OIS-210	???????	X	T
			T - taped
		X - uncolored clear	

Type definition, e.g. OIS-210 880-X -T

## LED Luminous Intensity Groups And Subgroups [ mW/sr ]

(general information – not this device specific)

C:	0.28 - 0.45	C1:	0.28 - 0.36	J1:	4.50 - 5.60
D:	0.45 - 0.71	C2:	0.36 - 0.45	J2:	5.60 - 7.10
E:	0.71 - 1.12	D1:	0.45 - 0.56	K1:	7.10 - 9.00
F:	1.12 - 1.80	D2:	0.56 - 0.71	K2:	9.00 - 11.20
G:	1.80 - 2.80	E1:	0.71 - 0.90	L1:	11.20 - 14.00
H:	2.80 - 4.50	E2:	0.90 - 1.12	L2:	14.00 - 18.00
J:	4.50 - 7.10	F1:	1.12 - 1.40	M1:	18.00 - 22.40
K:	7.10 - 11.20	F2:	1.40 - 1.80	M2:	22.40 - 28.00
L:	11.20 - 18.00	G1:	1.80 - 2.24	N1:	28.00 - 35.50
M:	18 - 28	G2:	2.24 - 2.80	N2:	35.50 - 45.00
N:	28 - 45	H1:	2.80 - 3.55	P1:	45.00 - 56.00
P:	45 - 71	H2:	3.55 - 4.50	P2:	56.00 - 71.00

**Measured according to CIE 127. All SMD-LEDs are 100% measured and selected on full automated equipment with an accuracy of  $\pm 11$  %.**

## Tape And Reel Packing

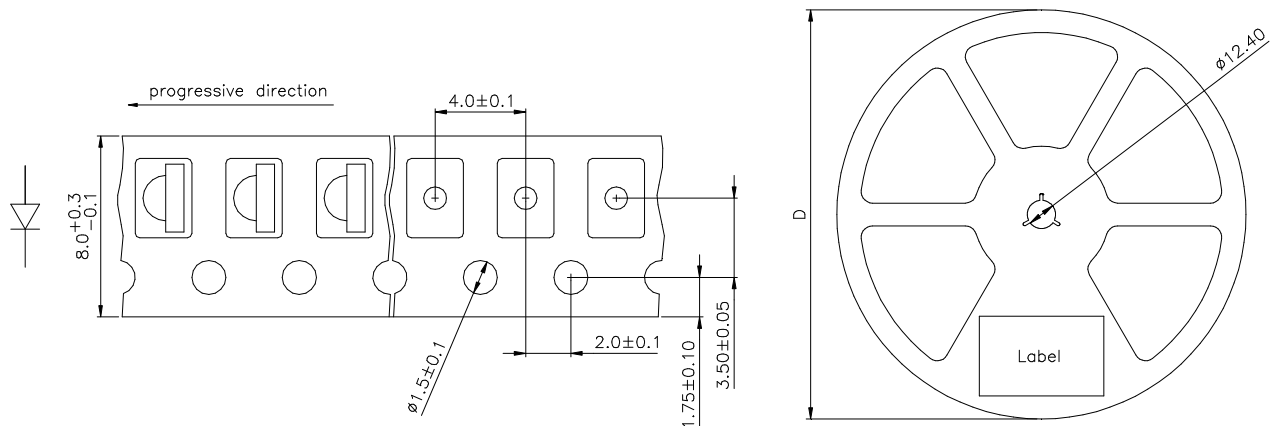

D	Parts/reel
180 mm	3000
330 mm	12000

**Packing:** The reel is sealed in special plastic bag with integrate ESD protection ( MIL - STD 81705 ) including a silica dry-pack

### Label

Order No.	XXXXXXXXXX	Customer order No.
Type	OIS-210 ?????-??-T	
Intensity group	ZZ	
Charge No.	1122-AAAAAA	11 Week – 22 year – A internal identification
Quantity	9999	

Attention please:

The information describes the type of component and shall not considered as assured characteristics. Terms of delivery and rights to change reserved.

Due to technical requirements components may contain dangerous substances.

The data sheet may changed without prior information; the valid issue will be on our webpage in internet.

Packaging:

Please use the recycling operators known to you.

Components used in life support devices or systems and safety systems must be expressly authorized for such purpose!