

## FEATURES

- Accepts 0-5V and 0-10V inputs
- Large, easy-to-read, 0.37"/9.4mm LED display
- Choice of 5 LED power/color options
- High input impedance, 100kΩ
- +5V to +40V model draws 9mA typ.
- Miniature size: 1.38" x 1.25" x 0.95"
- High-quality, 20-turn, span (gain) and zero (offset) adjustments
- DIP-switch selectable range and decimal points
- Vibration-resistant package; Reliable screw-terminal input connections
- Hundreds of different input/readout combinations

DATEL's DMS-20PC-0/5 Series are the world's smallest, full-featured, 0-5V input process control monitors. Their large, easy-to-read, 0.37"/9.4mm LED displays are available in a choice of 4 LED color/intensity options: standard red, standard green, super-bright red, and low-power red. Two power supply input ranges are also available: the industry-standard +5V and a wide-range +5V to +40V (which typically draws 9mA at +24V).

Gain (span) and offset (zero) adjustments are performed with on-board, precision, 20-turn potentiometers. All decimal-point and range-change selections are made on an 8-position, vibration-resistant, gold-plated DIP switch. Unlike competitive meters, there are no jumpers or solder gaps to open or close, and to further enhance reliability, the entire assembly utilizes 100% soldered connections. Both power-supply and input-signal connections are made via reliable screw-type terminal blocks.

The DMS-20PC-0/5's DIP switch and potentiometers accommodate hundreds of input-voltage/output-reading combinations. This practically eliminates the need for more costly, long-lead-time, factory "specials" in applications which use several different-range meters. A supplied bezel assembly—featuring metal fasteners and a rubber gasket—simplifies panel mounting and also provides excellent resistance to environmental dust and moisture. All these outstanding features combine to make the DMS-20PC-0/5 the perfect meter for prototype and OEM, 0-5V input, process control monitoring.

## SIMPLIFIED SCHEMATIC DIAGRAM

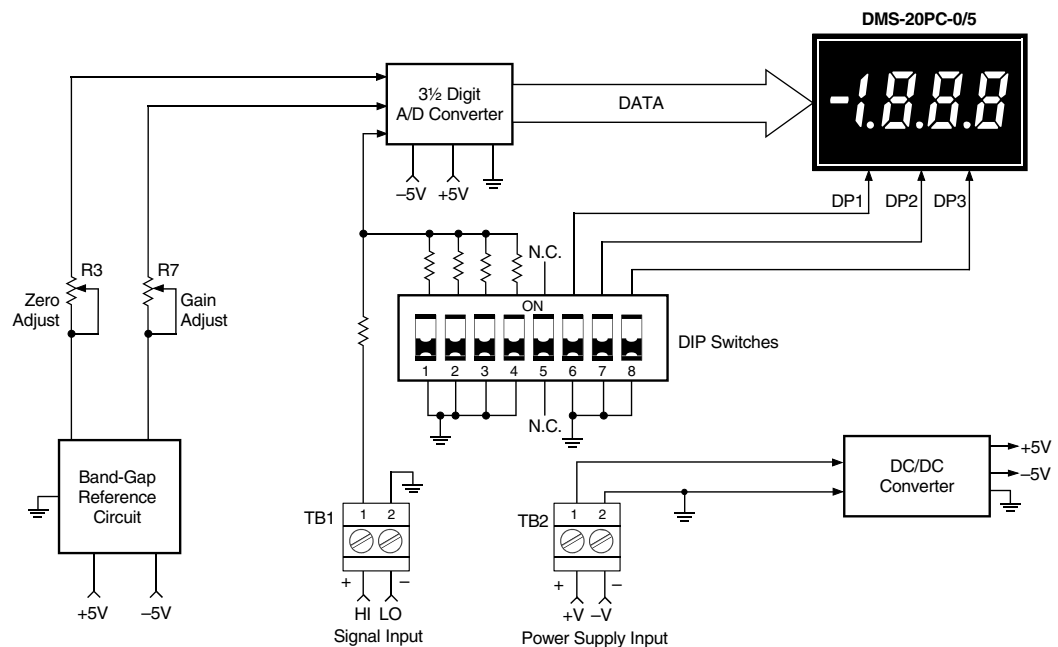

Figure 1. DMS-20PC-0/5 simplified schematic



## Performance/Functional Specifications

Typical at T<sub>A</sub> = +25°C, unless otherwise noted.

Inputs	Min.	Typ.	Max.	Units
Full Scale Input Range ①	4.9	5.0	5.1	Volts
Input Impedance	100	–	140	kΩ
Overvoltage Protection ②	–	–	±40	Volts
<b>Performance</b>				
Sampling Rate	2.5 reading per second			
Accuracy (1 minute warm-up):	±0.05%FS ±1 Count			
Temperature Drift (0 to +60°C)	–	±0.15	±0.3	Cnts/°C
<b>Power Supply Requirements</b>				
DMS-20PC-0/5-5RS (@90mA max.)	+4.75	+5.00	+5.25	Volts
DMS-20PC-0/5-5GS (@120mA max.)	+4.75	+5.00	+5.25	Volts
DMS-20PC-0/5-5RL (@15mA max.)	+4.75	+5.00	+5.25	Volts
DMS-20PC-0/5-5RH (@90mA max.)	+4.75	+5.00	+5.25	Volts
DMS-20PC-0/5-24RS (@15mA max.)	+4.75	–	+40.0	Volts
<b>Display</b>				
Display Type and Size	3½ digit, 0.37"/9.4mm high LED			
Polarity Indication	"–" for negative V <sub>IN</sub>			
Overrange Indication	"–1_ _ _" for negative inputs "1_ _ _" for positive inputs			
<b>Physical/Environmental</b>				
Operating Temperature	0	–	+60	°C
Storage Temperature	–20	–	+75	°C
Humidity (non-condensing)	0	–	95	%
Case Material	Polycarbonate			
Weight	0.6 ounces (17 grams)			

① The DMS-20PC-0/5 can also be used in most 0-10V applications. See the section on 0-10V inputs for more information. See Note 3 on Table 1.

② INPUT LO (TB1 "–LO") is internally connected to the power return (TB2 "–V"). Overvoltage specifications apply to the INPUT HI (TB1 "+HI") connection.

## Ordering Information

<b>DMS-20PC-0/5-5RS-C</b>	+5V supply, standard-intensity red LED's
<b>DMS-20PC-0/5-5GS-C</b>	+5V supply, standard-intensity green LED's
<b>DMS-20PC-0/5-5BS-C</b>	+5V supply, bright blue LED's
<b>DMS-20PC-0/5-5RL-C</b>	+5V supply, low-power red LED's
<b>DMS-20PC-0/5-5RH-C</b>	+5V supply, high-intensity red LED's
<b>DMS-20PC-0/5-24RL-C</b>	+5V to +40V supply, low-power red LED's
<b>DMS-PS1-CM-C</b>	+5V/1.0A AC/DC power supply module
<b>DMS-PS4-CM-C</b>	+24V/0.45A AC/DC power supply module
<b>DMS-PS7-CM-C</b>	+24V/0.7A AC/DC power supply module

**DMS-20-CP** Panel cutout punch

Note: A DMS-BZL4 bezel assembly with a sealing gasket is supplied with each meter.

## TECHNICAL NOTES

**1. Input Configuration:** The DMS-20PC-0/5 has its input low terminal (TB1 "LO") internally connected to the power supply ground terminal (TB2 "–V"). This connection effectively places the meter's input in a single-ended configuration. In some applications, single-ended inputs can cause ground-loop induced errors (the meter's display becomes unstable or bounces). This occurs because the LED drive currents flow through both the –V terminal and the signal LO terminal.

If suspected ground-loop errors are encountered, and the input signal LO terminal is externally connected to –V somewhere else in the system, try removing the connection to TB1 "LO". Inputs which have no ground-return connection to –V (commonly referred to as "floating inputs") must have their most negative potential tied to TB1 "LO". Please consult DATEL for more information.

Applications which require electrical isolation between the input signal source and the system power supply must use a separate transformer-isolated supply to power the meter.

**2. Panel Mounting:** In most standard through-the-panel installations, the DMS-20PC-0/5 must be secured to the panel with DMS-BZL4 bezel assemblies (see the Mechanical Specifications section for more information).

## OPERATING AND SETUP INSTRUCTIONS

As shipped, the DMS-20PC-0/5 is factory calibrated to read "000" for a 0.0V input and "1999" for a 5.0V input. The following worst-case procedure assumes the DMS-20PC-0/5 is completely mis-adjusted, i.e., both potentiometers and the DIP switches are randomly set.

1. Set R7 (full scale span/gain adjust) and R3 (zero/offset adjust) fully clockwise, roughly 22 turns, and place SW1-SW8 to OFF (down position).
2. Select DIP switch setting #1 in Table 1.
3. Apply a precision 0.0V input and adjust R3 until the meter's display reads "000".
4. Apply a precision 5.0V input and adjust R7 until the meter's display reads "1999". Repeat steps 3 and 4 to make sure the adjustments do not affect one another.
5. Select the appropriate decimal point by setting SW6, SW7 or SW8 to ON (DP1, DP2 or DP3 respectively).

NOTE: The "000" to "1999" display readings referred to in the instructions above are for illustrative purposes only. If other display readings such as "000" to "1200" are desired, refer to the DIP-Switch Settings Tables for SW1-SW4 settings. (SW5 is reserved for future use, it has no affect on display operation.) The initial setting of R3 and R7 fully clockwise is recommended in the adjustment procedure for all the following examples.

### Examples (0-5V Inputs)

1. Desired display readings are:

0.0V input = "0.00"  
5.0V input = "6.00"

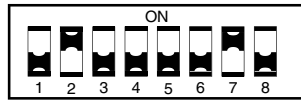

Use DIP-switch setting #3 in Table 1 and enable decimal point DP2 via SW7. Apply 0.0V and adjust R3 so the display reads "0.00". Apply 5.0V and adjust R7 so the display reads "6.00".

2. Desired display readings are:

0.0V input = "000"  
5.0V input = "800"

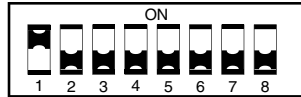

Use DIP-switch setting #2 in Table 1. Apply 0.0V and adjust R3 so the display reads "000". Apply 5.0V and adjust R7 so the display reads "800". For these display readings, no decimal points are used. Set SW6, SW7 and SW8 to OFF.

3. Desired display readings are:

0.0V input = ".000"  
5.0V input = ".250"



Use DIP-switch setting #5 in Table 1 and enable decimal point DP1 via SW6. Apply 0.0V and adjust R3 so the display reads ".000". Apply 5.0V and adjust R7 so the display reads ".250".

**Table 1. 0-5V DIP-Switch Settings** ③

Display Reading	SW1	SW2	SW3	SW4
0.0V Input    5.0V Input				
1. 000        1200-1999	Off	Off	Off	Off
2. 000        700-1200	On	Off	Off	Off
3. 000        400-700	Off	On	Off	Off
4. 000        300-400	Off	Off	On	Off
5. 000        190-300	Off	On	On	Off
6. 000        120-190	Off	Off	On	On
7. 000        100-150	Off	On	On	On
8. 000        90-140	On	On	On	On

③ The DMS-20PC-0/5 is optimized for handling 5V signal ranges that are positioned between -0.1V and +6.0V. As such, input ranges can be anywhere between -0.1V to +4.9V and +1.0V to +6.0V as long as their full range is 5 Volts. The meter's zero/offset potentiometer (R3) has enough adjustment range to produce a "000" display reading for input signal levels between -0.1V and +1.0V.

Please note the DMS-20PC digital panel meter from which the DMS-20PC-0/5 is derived has an accuracy specification of ±2 counts (max.). Thus, it may not always be possible to obtain the exact desired display readings.

4. Desired display readings are:

1.0V input = "000"  
6.0V input = "090"

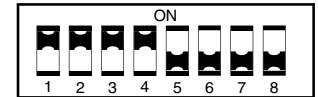

Even though this input is positioned between +1.0V and +6.0V, it still meets the 5V full scale input range listed in the Functional Specifications section. Use DIP-switch setting #8 in Table 1. Apply 1.0V and adjust R3 so the display reads "000". Apply 6.0V and adjust R7 so the display reads "090". With this type of input, it is advisable to recheck both input levels to be sure the potentiometer settings do not affect one another.

### 0-10V Inputs

While the DMS-20PC-0/5 is optimized for operation with 0-5V inputs, its versatile input stage can also accommodate most 0-10V applications. The meter's zero/offset potentiometer (R3) has enough adjustment range to produce a "000" display reading with input signal levels between -0.1V and +1.0V. Table 2. summarizes the available ranges when the DMS-20PC-0/5 is used with 0-10V inputs.

#### Example (0-10V Inputs)

1. Desired display readings are:

0.0V input = "000"  
10.0V input = "500"

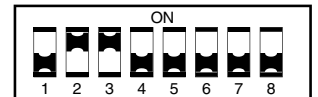

Use DIP switch setting #4 in Table 2. Apply 0.0V and adjust R3 so the display reads "000". Apply 10.0V and adjust R7 so the display reads "500".

**Table 2. 0-10V DIP-Switch Settings**

Display Reading	SW1	SW2	SW3	SW4
0.0V Input    10.0V Input				
1. 000        1400-1999	On	Off	Off	Off
2. 000        800-1400	Off	On	Off	Off
3. 000        600-800	Off	Off	On	Off
4. 000        380-600	Off	On	On	Off
5. 000        240-380	Off	Off	On	On
6. 000        200-300	Off	On	On	On
7. 000        180-280	On	On	On	On

## MECHANICAL SPECIFICATIONS

TOLERANCES: 2 PL DEC ±0.02 (±0.51)  
 3 PL DEC ±0.010 (±0.254)  
 WIRE SIZE: 18 to 26 AWG (Solid or stranded)  
 STRIPPING LENGTH: 0.20" (5.08mm)

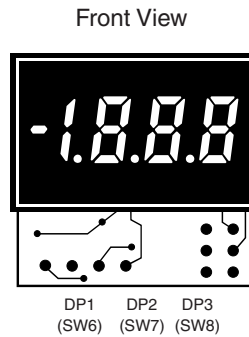
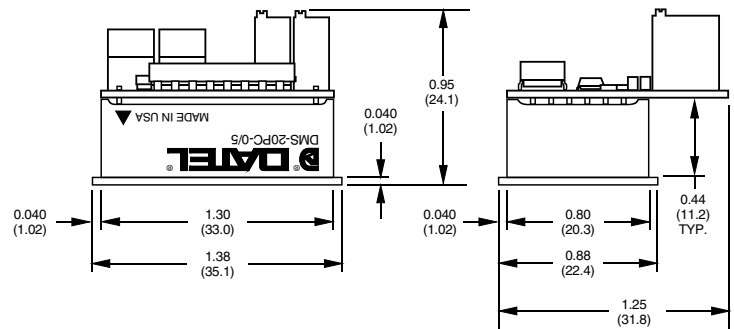
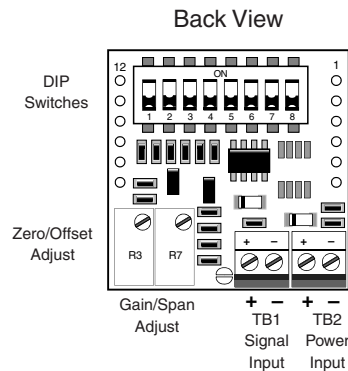

## BEZEL INSTALLATION AND RECOMMENDED DRILL AND PANEL CUTOUT

