

Product Features

- Small size by using simple matching circuit board
- Single Supply Voltage
- Heat sink 99.9% copper, gold plated
- High Productivity
- Low Manufacturing Cost
- GaAs HFET

Application

- UMTS Repeater
- RF Sub-Systems
- Base Station

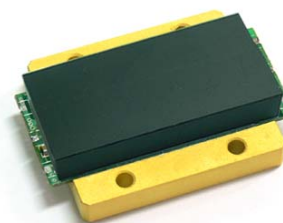

Package : DP-56

Description

The power amplifier module is designed for base stations and cell extenders and operating frequency range is from 1.9GHz to 3.5GHz

GaAs HFET is used and attached on a copper sub carrier. It is connected by using bias and in/out matching circuit method with gold wire bonding.

The bias and matching circuit are designed much simpler than other circuits for silicon IC's, LDMOS because GaAs HFET is operated by low supply voltage whereas others are operated by high supply voltage.

For better thermal conductivity, enhanced mode PCB was used in the 99.9% copper gold plate heat sink.

This simplicity results cost competitiveness and performance enhancement.

Specifications

PARAMETER	RFT2140-08
Frequency Range (MHz)	2110 ~ 2170
Small Signal Gain (dB)	26
Gain Flatness (Max.)	± 1dB @ 50MHz BW
Input Return Loss	-10dB
Output P1dB	38 dBm
W-CDMA Power (1 FA)	30dBm @ -45dBc ACLR
Output IP3	51dBm @ tone / 25dBm
Noise Figure (Typ.)	4 dB
Drain Voltage	9V
Drain Current	1.5A
Operating Temp Range	-20°C ~ +70°C
Dimensions (W×L×H)	32.0 × 44.0 × 10.0 [mm]

NOTE

*Test condition: 2140MHz, 3GPP W-CDMA signal modulation
Test Model 1, 64DPCH, 3.84MHz BW, ±5MHz offset

* RFT Series : Internally Matched Module

Performance Charts ($V_d=9V$, $I_d=1.5A$, $T=25^\circ C$)

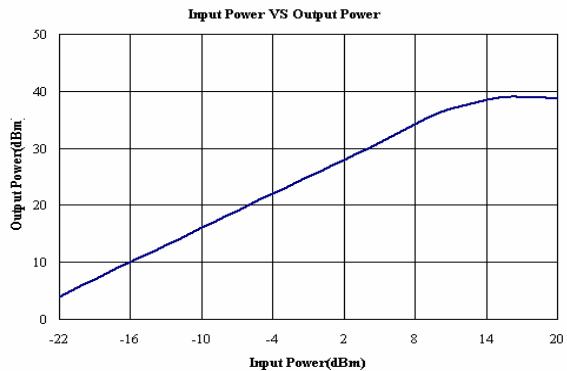
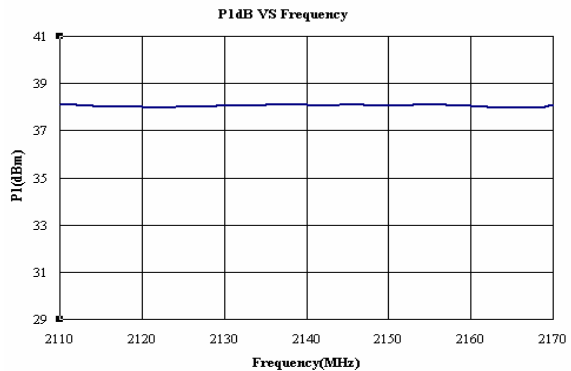
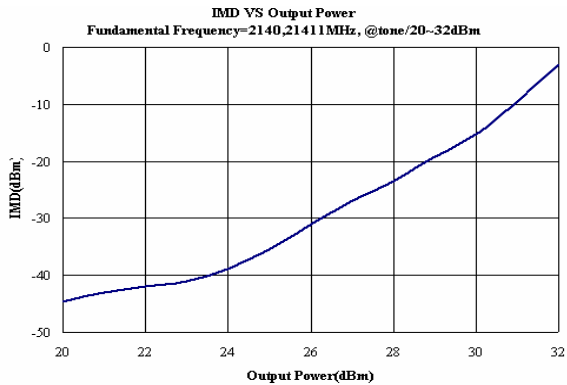
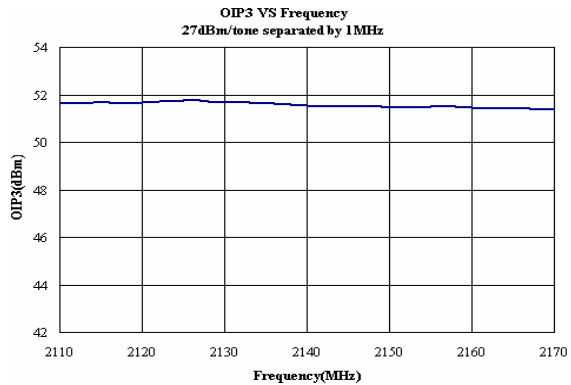
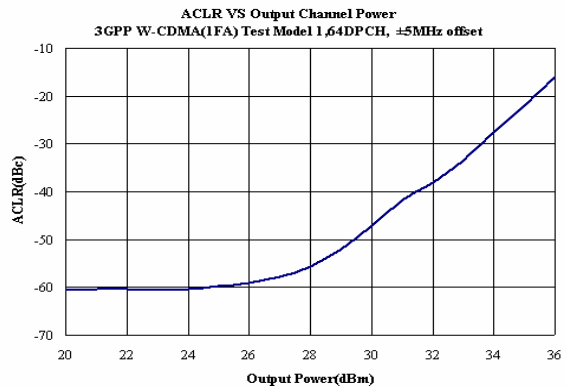
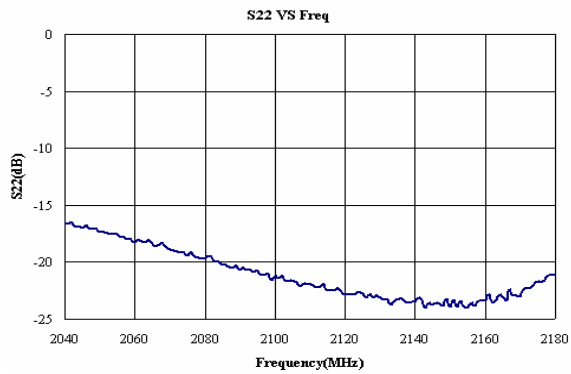
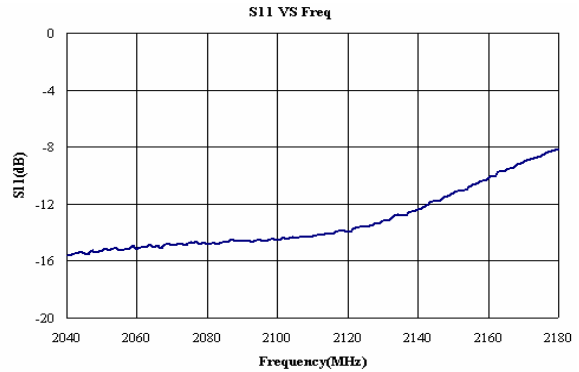
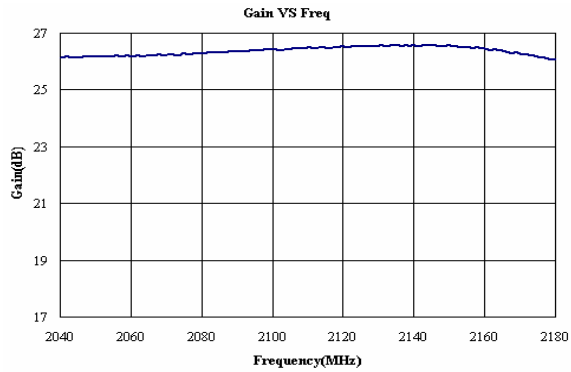

Package Dimensions (Type: DP-56)

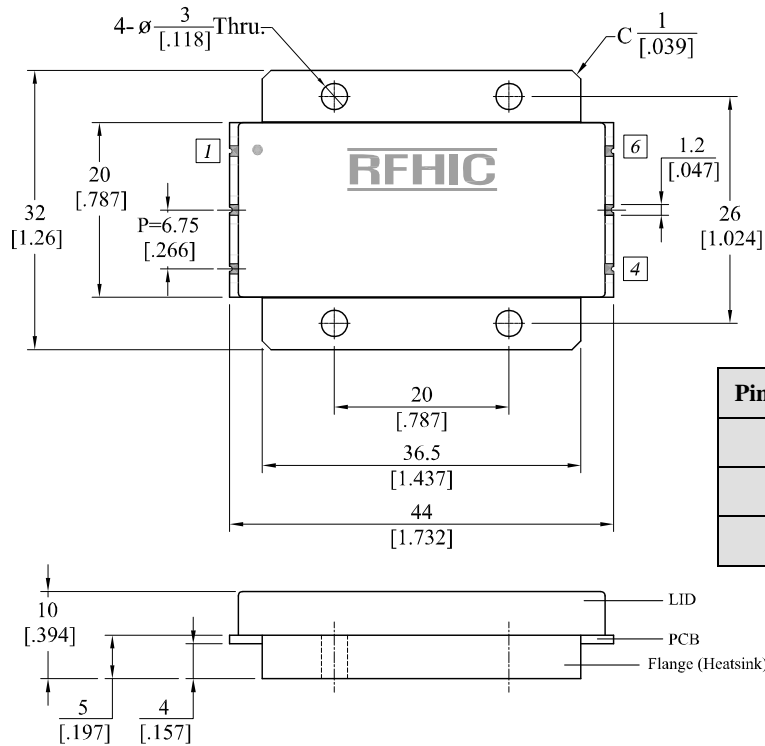

Pin NO	Function	Pin NO	Function
1	GND	6	Vcc
2	RF IN	5	RF OUT
3	E/N	4	GND

Installation Guideline

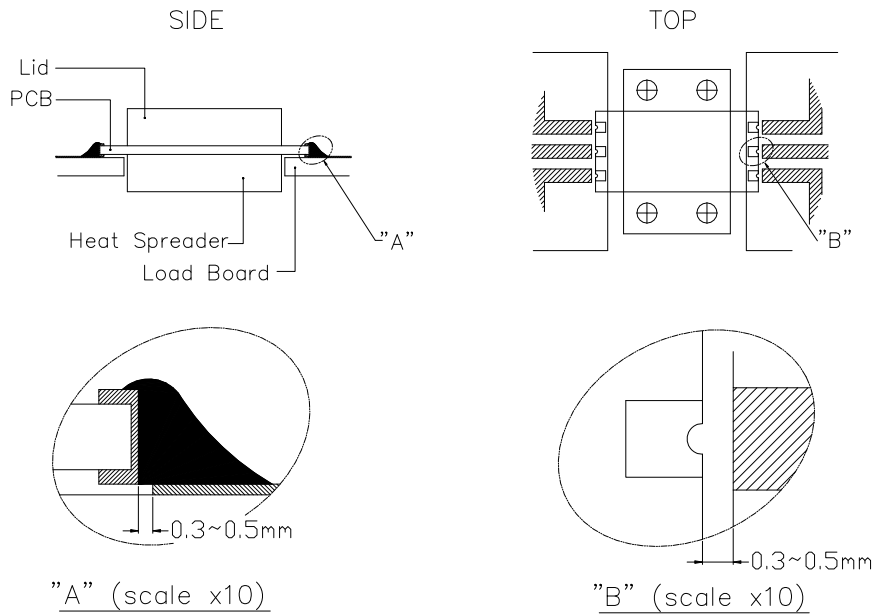

★ It can be easily removed with solder wick and other removable material

RFHIC Corporation (RFHIC) reserves the right to make changes to any products herein or to discontinue any product at any time without notice. RFHIC do not assume any liability for the suitability of its products for any particular purpose, and disclaims any and all liability, including without limitation consequential or incidental damages. The product specifications herein expressed have been carefully checked and are assumed to be reliable. However, RFHIC disclaims liability for inaccuracies and strongly recommends buyers to verify that the information they are using is current before placing purchase orders. RFHIC products are not intended for use in life support equipment or application where malfunction of the product can be expected to result in personal injury or death. Buyer uses or sells such products for any such unintended or unauthorized application, buyer shall indemnify, protect and hold RFHIC and its directors, officers, stockholders, employees, representatives and distributors harmless against any and all claims arising out of such use. RFHIC's liability under or arising out of damages, claims of whatsoever kind and nature which RFHIC products could cause shall be limited in amount to the net purchase price of the products sold to buyer by RFHIC.