

ISOLATED DC/DC CONVERTERS

48 VDC Input 12 VDC/8.5 A Output, 1/16 Brick

bel
POWER PRODUCTS

SRCA-08S12L

RoHS Compliant

Rev.B

- Isolated
- Fixed Frequency
- High Efficiency
- High Power Density
- Low Cost
- Input Under Voltage Lockout
- Input Over Voltage Shutdown
- OCP/SCP
- Over Temperature Protection
- Remote On/Off



Description

The SRCA-08S12L is an isolated DC/DC converter that operates from a nominal 48 VDC source. These converters use a half bridge power train to provide isolation and step down. These units will provide up to 100 W of output power from a nominal 48 VDC input. These units are designed to be highly efficient and low cost. Features include remote on/off, over current protection and under voltage lockout. These converters are provided in an industry standard sixteenth-brick package.

Part Selection

Output Voltage	Input Voltage	Max. Output Current	Max. Output Power	Typical Efficiency	Model Number Active Low
12 V	36 V - 55 V	8.5 A	100 W	95%	SRCA-08S12L

- Notes:** 1. Add "G" suffix at the end of the model number to indicate Tray Packaging.
2. All part numbers above indicate RoHS 6. Change the second letter "R" to "7" for RoHS 5 part numbers.

Absolute Maximum Ratings

Parameter	Min	Typ	Max	Notes
Input Voltage (continuous)	-0.3 V	-	80 V	
Remote On/Off	-0.3 V	-	18 V	
I/O Isolation Voltage	-	500 V	-	
Ambient Temperature	-40 °C	-	85 °C	
Storage Temperature	-40 °C	-	125 °C	

Input Specifications

Parameter	Min	Typ	Max	Notes
Input Voltage	36 V	-	55 V	
Input Current (full load)	-	-	2.5 A	
Input Current (no load)	-	-	120 mA	
Remote Off Input Current	-	4 mA	10 mA	Active Low
Input Reflected Ripple Current (pk-pk)	-	40 mA	100 mA	Tested with simulated source impedance of 10 uH, 5 Hz to 20 MHz; use a 100 uF/100 V electrolytic capacitor and 1 uF/100 V ceramic capacitor at the input.
Input Reflected Ripple Current (rms)	-	10 mA	30 mA	
I ² t Inrush Current Transient	-	0.039 A ² s	0.062 A ² s	
Input Over Voltage Protection Threshold	-	59 V	-	
Turn On Voltage Threshold	-	35 V	-	
Turn Off Voltage Threshold	-	30 V	-	

ISOLATED DC/DC CONVERTERS

48 VDC Input 12 VDC/8.5 A Output, 1/16 Brick



Output Specifications

Parameter	Min	Typ	Max	Notes		
Output Voltage Set Point				I _{out} =no load		
Vin=36 V	8.8 V	9 V	9.2 V			
Vin=48 V	11.8 V	12 V	12.2 V			
Vin=55 V	13.5 V	13.75 V	13.95 V			
Line Regulation	-	4.75 V	5.0 V			
Load Regulation						
Vin=36 V	-	0.6 V	0.8 V			
Vin=48 V	-	0.6 V	0.8 V			
Vin=55 V	-	0.6 V	0.8 V			
Regulation Over Temperature (-40 °C to +85 °C)	-	100 mV	200 mV			
Output Current	0 A	-	8.5 A			
Current Limit Threshold	9 A	-	14 A			
Short Circuit Surge Transient	-	1.3 A ² s	2.1 A ² s			
Ripple and Noise (rms)	-	30 mV	60 mV	Test conditions: 0-20 MHz BW, with a 1 uF ceramic capacitor and a 10 uF Tantalum capacitor at the output; Vin=48 V.		
Ripple and Noise (pk-pk)	-	90 mV	150 mV			
Turn on Time	-	10 mS	20 mS			
Overshoot at Turn on	-	0%	3%			
Output Capacitance	0 uF	-	2000 uF			
Transient Response						
50% ~ 75% Max Load	Overshoot	Vin=48V	-	150 mV	350 mV	Test conditions: di/dt = 0.5 A/uS, Vin=48 V
	Settling Time		-	30 uS	100 uS	
75% ~ 50% Max Load	Overshoot		-	150 mV	350 mV	
	Settling Time		-	30 uS	100 uS	

Note: All specifications are typical at 25 °C unless otherwise stated.

General Specifications

Parameter	Min	Typ	Max	Notes
Efficiency	93%	95%	-	Vin=48V, I _o =I _{o,max}
Switching Frequency	160 kHz	190 kHz	220 kHz	
Isolation Capacitance	-	1500 pF	-	
Over Temperature Protection	-	115 °C	-	Average PCB temperature will not exceed 115 °C.
MTBF	3,008,073 hours			Calculated Per Bell Core SR-332 (I _o =80% full load; V _o =12 V; T _a = 25 °C)
Dimensions				
Inches (L × W × H)	1.3 x 0.9 x 0.4			
Millimeters (L × W × H)	33.0 x 22.9 x 10.2			
Weight	-	14.5 g	-	

Note: All specifications are typical at 25 °C unless otherwise stated.

ISOLATED DC/DC CONVERTERS

48 VDC Input 12 VDC/8.5 A Output, 1/16 Brick



Control Specifications

Parameter	Min	Typ	Max	Notes
Remote On/Off				
Signal Low (Unit On)	Active Low	-0.3 V	-	SRCA-08S12L. The remote on/off pin open, Unit off.
Signal High (Unit Off)		2.4 V	-	

Efficiency Data

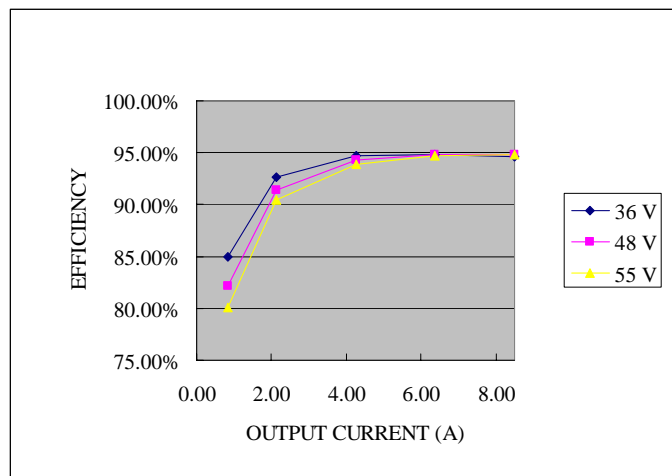

Thermal Derating Curve

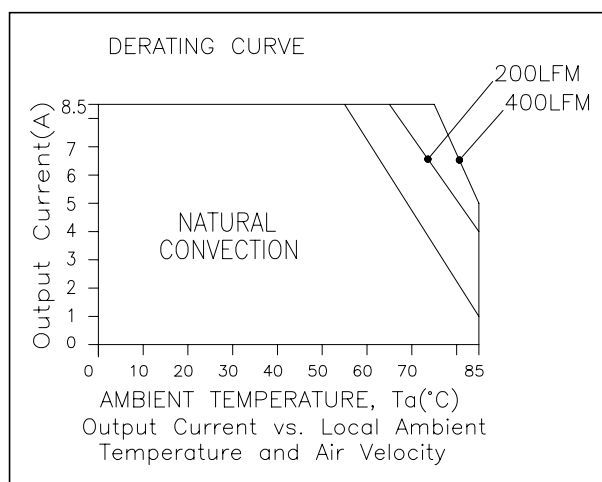

Note: Derating curve is tested at nominal input voltage.

ISOLATED DC/DC CONVERTERS

48 VDC Input 12 VDC/8.5 A Output, 1/16 Brick



Ripple and Noise Waveform

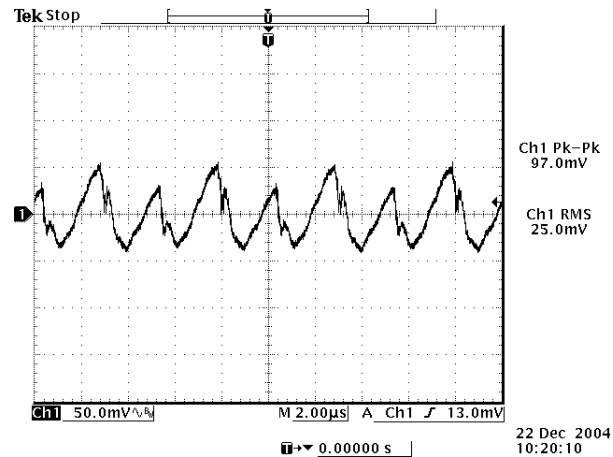

Note: Ripple and noise at full load, 48 V input and $T_a=25$ deg C, and with a 10 μ F tantalum capacitor and 1 μ F ceramic capacitor on output.

Transient Response Waveforms

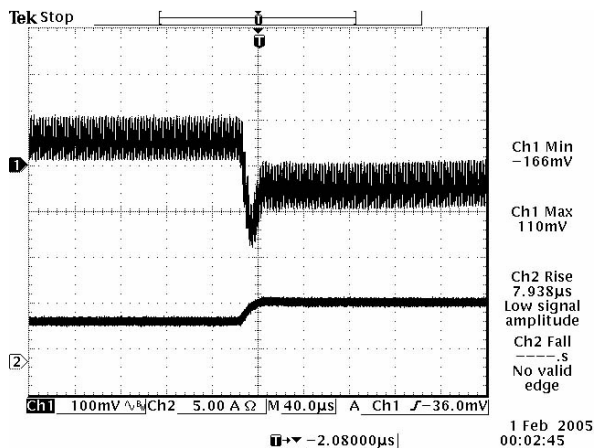

50% to 75% Transient at 48 V input

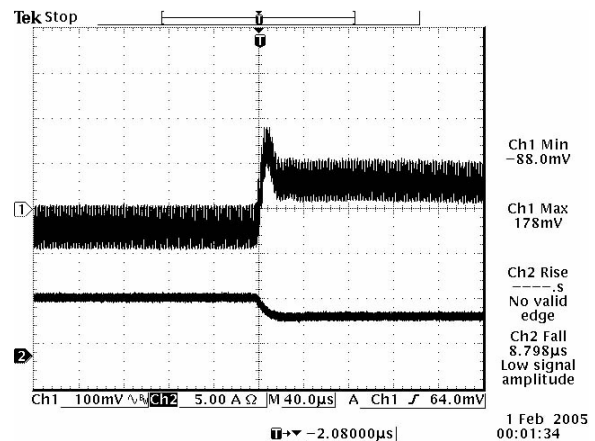

75% to 50% load Transient at 48 V input

Note: Transient response at $di/dt=0.5$ A/ μ S, $T_a=25$ deg C.

ISOLATED DC/DC CONVERTERS

48 Vdc Input 12 Vdc/8.5 A Output, 1/16 Brick



Mechanical Outline

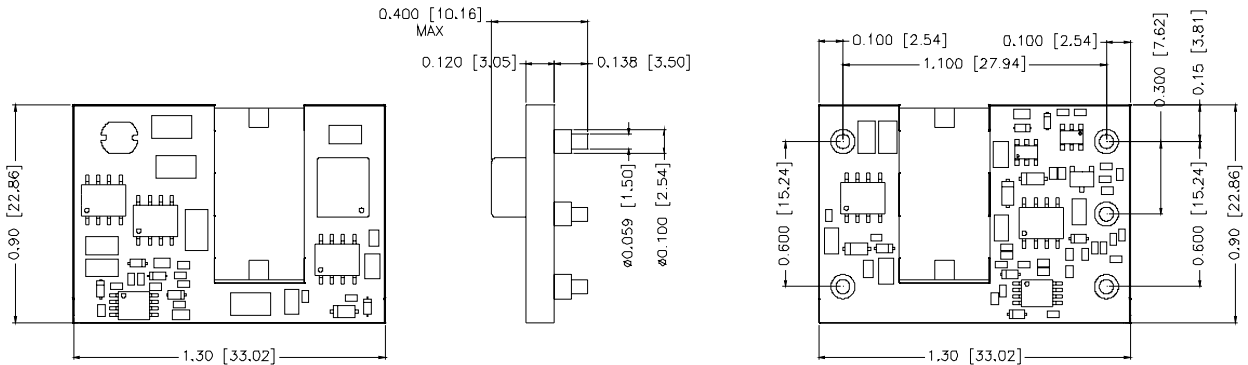

RECOMMENDED PAD LAYOUT

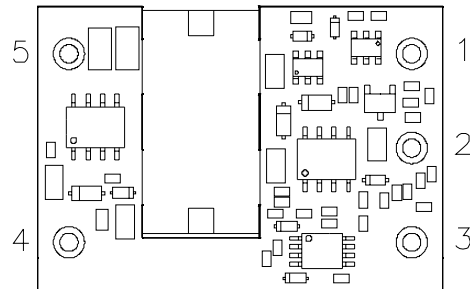
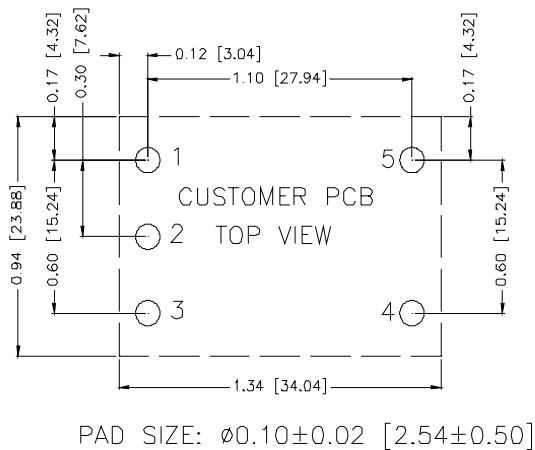

Pin Connections

Pin	Function
1	Vin+
2	Remote On/Off
3	Vin-
4	Vout-
5	Vout+

RoHS Compliance

Complies with the European Directive 2002/95/EC, calling for the elimination of lead and other hazardous substances from electronic products.



©2008 Bel Fuse Inc. Specifications subject to change without notice. 121808

CORPORATE

Bel Fuse Inc.
206 Van Vorst Street
Jersey City, NJ 07302
Tel 201-432-0463
Fax 201-432-9542
www.belfuse.com

FAR EAST

Bel Fuse Ltd.
8F/ 8 Luk Hop Street
San Po Kong
Kowloon, Hong Kong
Tel 852-2328-5515
Fax 852-2352-3706
www.belfuse.com

EUROPE

Bel Fuse Europe Ltd.
Preston Technology Management Centre
Marsh Lane, Suite G7, Preston
Lancashire, PR1 8UD, U.K.
Tel 44-1772-556601
Fax 44-1772-888366
www.belfuse.com