

## Surface Mount Ceramic Chip Capacitors High Temperature 200°C C0G MLCC



### Benefits and Features:

- No Piezoelectric Noise.
- Extremely low ESR and ESL.
- High Thermal Stability.
- High Ripple Current Capability.
- Preferred capacitance solution at line frequencies and into the MHz range.
- No capacitance change with respect to applied rated DC voltage.
- Minimal capacitance change with respect to temperature from -55°C to +200°C.
- No capacitance decay with time.
- Non-polar device.

### Applications:

Typical applications include critical timing, tuning, circuits requiring low loss, circuits with pulse, high current, decoupling, by-pass, filtering, transient voltage suppression, blocking and energy storage for use in extreme environments commonly present in applications such as down-hole exploration, aerospace engine compartments and geophysical probes.

KEMET's New High Temperature Surface Mount C0G MLCCs feature a robust and proprietary base metal dielectric system that offers industry-leading performance relative to capacitance and case size combined with capacitance stability at extreme temperatures up to +200°C. This new platform promotes downsizing opportunities of existing High Temperature C0G technology, and offers replacement opportunities of existing X7R/BX/BR technologies.

Standard capacitance ratings for these devices range from 0.5 pF up to 0.22 µF in capacitance tolerance offerings of ±0.25pF, ±0.5pF, ±1%, ±2%, ±5%, ±10%, or ±20%. The Temperature Coefficient of Capacitance (TCC) is ±30ppm/°C from -55°C to +200°. Devices are available in DC voltage ratings of 10V, 16V, 25V, 50V and 100V, with a maximum dissipation factor of 0.10%. Seven standard EIA case size options are available which include -0603, 0805, 1206, 1210, and 1812- with either nickel barrier/tin or Sn/Pb terminations.

### Outline Drawing

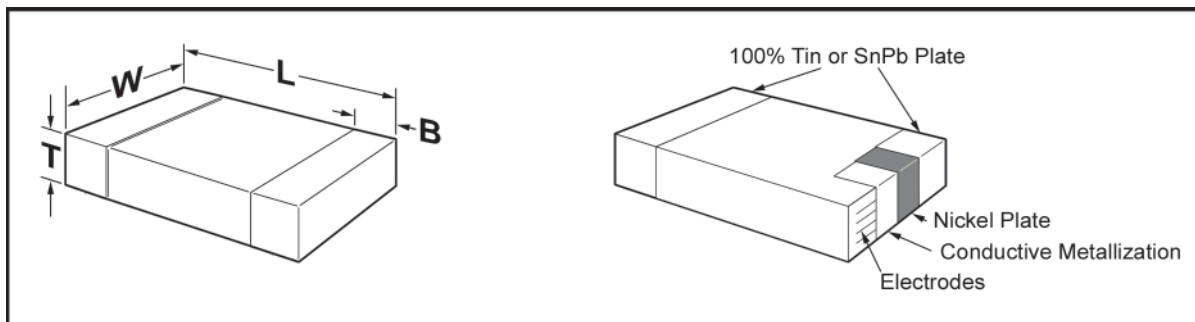

### Dimensions - Millimeters (Inches)

EIA SIZE CODE	METRIC SIZE CODE	L LENGTH	W WIDTH	B BANDWIDTH	S SEPARATION minimum
0603	1608	1.6 (.063) ± .15 (.006)	0.8 (.032) ± .15 (.006)	0.35 (.014) ± .15 (.006)	0.7 (.028)
0805	2012	2.0 (.079) ± .20 (.008)	1.25 (.049) ± .20 (.008)	0.50 (.020) ± .25 (.010)	0.75 (.030)
1206	3216	3.2 (.126) ± .20 (.008)	1.6 (.063) ± .20 (.008)	0.50 (.020) ± .25 (.010)	N/A
1210	3225	3.2 (.126) ± .20 (.008)	2.5 (.098) ± .20 (.008)	0.50 (.020) ± .25 (.010)	N/A
1812	4532	4.5 (.177) ± .30 (.012)	3.2 (.126) ± .30 (.012)	0.60 (.024) ± .35 (.014)	N/A

## Ordering Information

C	1210	H	124	J	5	G	A	C	TU
Ceramic	Case Size (L"x W")	Specification/ Series	Capacitance Code (pF)	Capacitance Tolerance	Voltage	Dielectric	Failure Rate/ Design	End Metallization (Plated)	Packaging/Grade (C-Spec)*
	0603 0805 1206 1210 1812	H = High Temp (200°C)	2 Sig. Digits + Number of Zeros* *Use 9 for 1.0 - 9.9pF *Use 8 for 0.5 - .99pF ex. 2.2pF = 229 ex. 0.5pF = 508	C = ±0.25pF D = ±0.5pF F = ±1% G = ±2% J = ±5% K = ±10% M = ±20%	8 = 10V 4 = 16V 3 = 25V 6 = 35V 5 = 50V 1 = 100V 2 = 200V	G = C0G	A = N/A	C = 100% Matte Sn L = SnPb (5% min)	Blank = Bulk TU = 7" Reel Unmarked TM = 7" Reel Marked

\*Contact KEMET for availability and ordering details if you require additional reeling or packaging options.

Additional termination options may be available, contact KEMET for details.

## Electrical Parameters/Characteristics

<b>Operating Temperature Range:</b> -55°C to +200°C
<b>Temperature Coefficient of Capacitance :</b> ±30PPM/°C (up to 200°C)
<b>Aging Rate (Max % Cap Loss/Decade Hour):</b> 0%
<b>Dielectric Withstanding Voltage:</b> 250%
<b>Dissipation Factor (DF) @ 25°C:</b> .001 (0.10%) Max
<b>Insulation Resistance (IR) Limit @ 25°C:</b> 1000 megohm microfarads or 100GΩ <b>Insulation Resistance (IR) Limit @ 200°C:</b> 10 megohm microfarads or 1GΩ

**Capacitance and Dissipation Factor (DF) measured under the following conditions:**

1kHz and 1 Vrms if capacitance >1000pF  
 1MHz and 1 Vrms if capacitance ≤1000pF

## Qualification/Certification

RoHS-PRC (6/6) - 100% matte Sn termination

<b>Product Qualification Test Plan</b>	
<b>RELIABILITY/ ENVIRONMENTAL TESTS per MIL-STD-202/JESD22</b>	
High Temperature Life	200°C, Rated Voltage, 2000 Hours.
Load Humidity	85°C /85%RH, Rated Voltage, 1000 Hours.
Low Voltage Humidity	85°C /85%RH, 1.5V, 1000 Hours.
Temperature Cycling	-55°C to +200°C, 50 Cycles.
Thermal Shock	-55°C to +150°C, 20s transfer, 15 min dwell, 300 Cycles.
Moisture Resistance	Cycled Temp / RH. 0V, 10 cycles @ 24 Hrs each.
<b>PHYSICAL, MECHANICAL &amp; PROCESS TESTS per MIL-STD 202/JIS-C-6429</b>	
Resistance to Solvents	Include Aqueous wash chemical - OKEM Clean or equivalent.
Mechanical Shock and Vibration	Method 213: Figure 1, Condition F Method 204: 5 gs for 20 min, 12 cycles.
Resistance to Soldering Heat	Condition B, no pre-heat of samples, Single Wave Solder.
Terminal Strength	Force of 1.8 kg for 60 seconds.
Board Flex	3mm minimum.

# Electrical Characteristics

Delta Cap vs. Temperature (Typical)

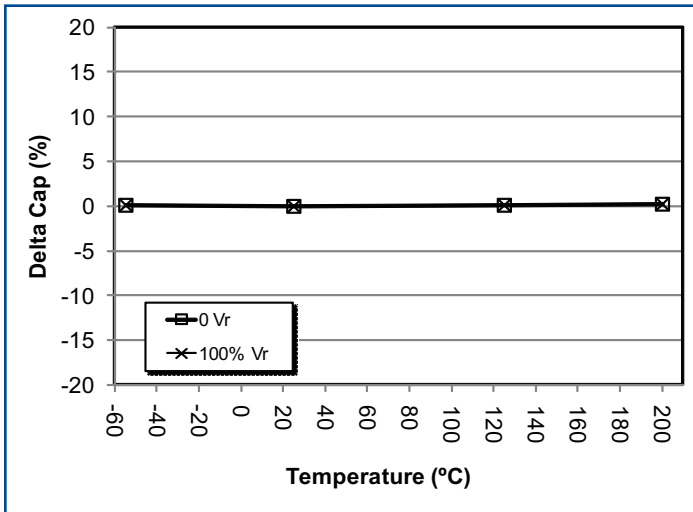

C1210H104J1GAC - Life Test IR Distribution (Lognormal)

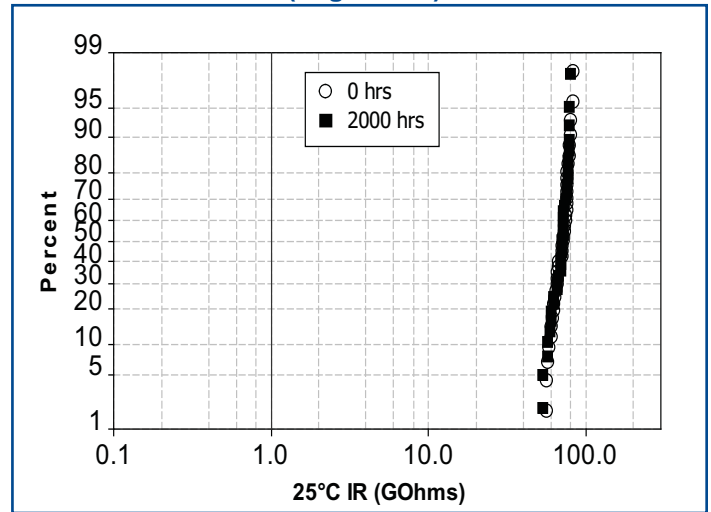

Capacitance vs. Temperature with 25V DC bias (Rated Voltage)

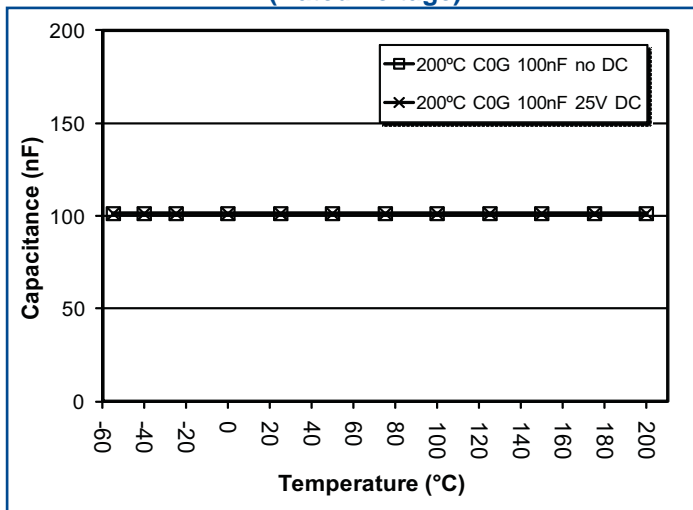

DF vs. Temperature without DC bias.

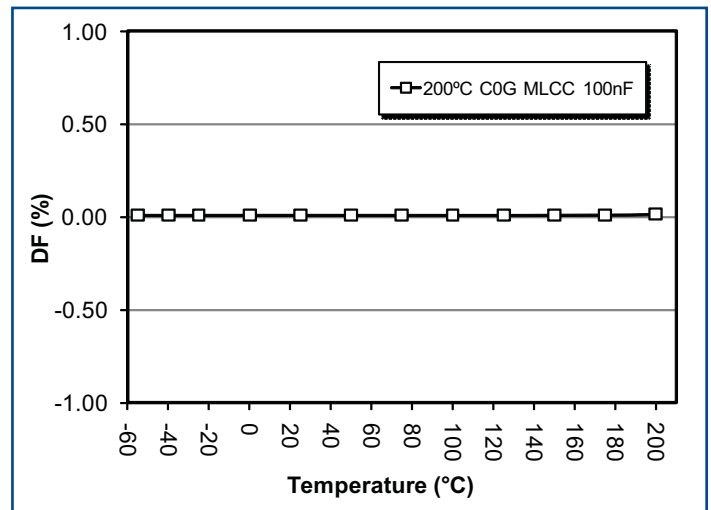

IR vs. Temperature with 25V DC bias (Rated Voltage)

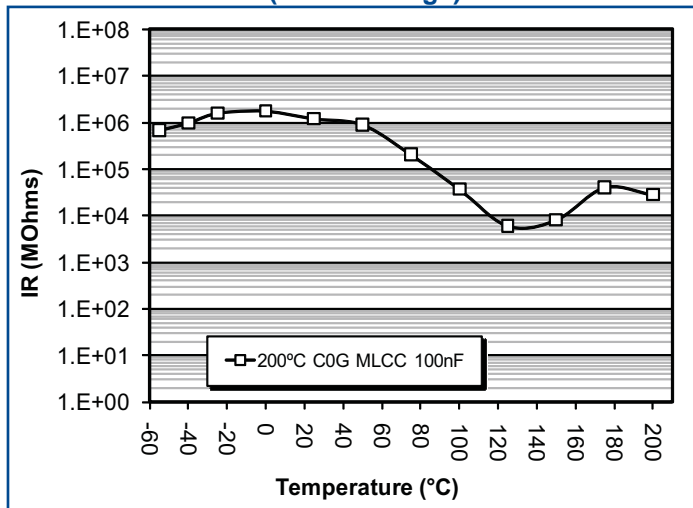

BME vs. PME/IR vs. Temperature with 25V DC bias (Rated Voltage)

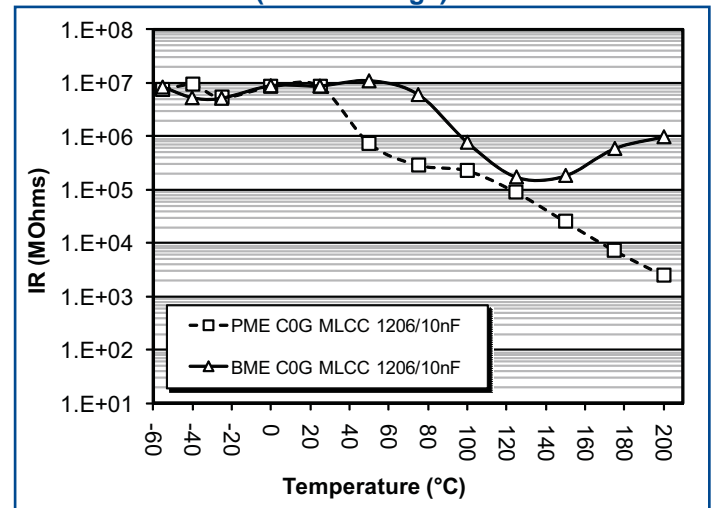



## Chip Thickness / Packaging Quantities

**Thickness Code Reference Chart**  
**Packaging Quantity Based on Finished Chip Thickness Specifications**

Thickness Code	Chip Size	Thickness ± Range (mm)	Qty per Reel 7" Plastic	Qty per Reel 13" Plastic	Qty per Reel 7" Paper	Qty per Reel 13" Paper	Qty per Bulk Cassette
AA	01005	0.20 ± 0.02	--	--	15000	--	--
AB	0201	0.30 ± 0.03	--	--	15000	--	--
BB	0402	0.50 ± 0.05	--	--	10000	50000	50000
CB	0603	0.80 ± 0.07	--	--	4000	10000	15000
CC	0603	0.80 ± 0.10	--	--	4000	10000	--
CD	0603	0.80 ± 0.15	--	--	4000	10000	--
DB	0805	0.60 ± 0.10	--	--	4000	10000	10000
DC	0805	0.78 ± 0.10	--	--	4000	10000	--
DD	0805	0.90 ± 0.10	--	--	4000	10000	--
DE	0805	1.00 ± 0.10	2500	10000	--	--	--
DF	0805	1.10 ± 0.10	2500	10000	--	--	--
DG	0805	1.25 ± 0.15	2500	10000	--	--	--
DH	0805	1.25 ± 0.20	2500	10000	--	--	--
DL	0805	0.95 ± 0.10	4000	10000	--	--	--
EB	1206	0.78 ± 0.10	4000	10000	4000	10000	--
EC	1206	0.90 ± 0.10	4000	10000	--	--	--
ED	1206	1.00 ± 0.10	2500	10000	--	--	--
EE	1206	1.10 ± 0.10	2500	10000	--	--	--
EF	1206	1.20 ± 0.15	2500	10000	--	--	--
EG	1206	1.60 ± 0.15	2000	8000	--	--	--
EH	1206	1.60 ± 0.20	2000	8000	--	--	--
EJ	1206	1.70 ± 0.20	2000	8000	--	--	--
EK	1206	0.80 ± 0.10	2000	8000	--	--	--
EM	1206	1.25 ± 0.15	2500	10000	--	--	--
EN	1206	0.95 ± 0.10	4000	10000	--	--	--
FB	1210	0.78 ± 0.10	4000	10000	--	--	--
FC	1210	0.90 ± 0.10	4000	10000	--	--	--
FD	1210	0.95 ± 0.10	4000	10000	--	--	--
FE	1210	1.00 ± 0.10	2500	10000	--	--	--
FF	1210	1.10 ± 0.10	2500	10000	--	--	--
FG	1210	1.25 ± 0.15	2500	10000	--	--	--
FH	1210	1.55 ± 0.15	2000	8000	--	--	--
FJ	1210	1.85 ± 0.20	2000	8000	--	--	--
FK	1210	2.10 ± 0.20	2000	8000	--	--	--
FL	1210	1.40 ± 0.15	2000	8000	--	--	--
FM	1210	1.70 ± 0.20	2000	8000	--	--	--
FN	1210	1.85 ± 0.20	2000	8000	--	--	--
FO	1210	1.50 ± 0.20	2000	8000	--	--	--
FP	1210	1.60 ± 0.20	2000	8000	--	--	--
FR	1210	2.25 ± 0.20	2000	8000	--	--	--
FS	1210	2.50 ± 0.20	1000	4000	--	--	--
FT	1210	1.90 ± 0.20	1500	4000	--	--	--
GB	1812	1.00 ± 0.10	1000	4000	--	--	--
GC	1812	1.10 ± 0.10	1000	4000	--	--	--
GD	1812	1.25 ± 0.15	1000	4000	--	--	--
GE	1812	1.30 ± 0.10	1000	4000	--	--	--
GF	1812	1.50 ± 0.10	1000	4000	--	--	--
GG	1812	1.55 ± 0.10	1000	4000	--	--	--
GH	1812	1.40 ± 0.15	1000	4000	--	--	--
GJ	1812	1.70 ± 0.15	1000	4000	--	--	--
GK	1812	1.60 ± 0.20	1000	4000	--	--	--
GL	1812	1.90 ± 0.20	1000	4000	--	--	--
GM	1812	2.00 ± 0.20	1000	4000	--	--	--
GN	1812	1.70 ± 0.20	1000	4000	--	--	--
GO	1812	2.50 ± 0.20	500	2000	--	--	--
HB	1825	1.10 ± 0.15	1000	4000	--	--	--
HC	1825	1.15 ± 0.15	1000	4000	--	--	--
HD	1825	1.30 ± 0.15	1000	4000	--	--	--
HE	1825	1.40 ± 0.15	1000	4000	--	--	--
HF	1825	1.50 ± 0.15	1000	4000	--	--	--
HG	1825	1.60 ± 0.20	1000	4000	--	--	--
JB	2220	1.00 ± 0.15	1000	4000	--	--	--
JC	2220	1.10 ± 0.15	1000	4000	--	--	--
JD	2220	1.30 ± 0.15	1000	4000	--	--	--
JE	2220	1.40 ± 0.15	1000	4000	--	--	--
JF	2220	1.50 ± 0.15	1000	4000	--	--	--
JG	2220	1.70 ± 0.15	1000	4000	--	--	--
JH	2220	1.80 ± 0.15	1000	4000	--	--	--
JO	2220	2.40 ± 0.15	500	2000	--	--	--
JP	2220	1.60 ± 0.20	1000	4000	--	--	--
KB	2225	1.00 ± 0.15	1000	4000	--	--	--
KC	2225	1.10 ± 0.15	1000	4000	--	--	--
KD	2225	1.30 ± 0.15	1000	4000	--	--	--
KE	2225	1.40 ± 0.15	1000	4000	--	--	--
KF	2225	1.60 ± 0.20	1000	4000	--	--	--
LA	1808	1.40 ± 0.15	1000	4000	--	--	--
LB	1808	1.60 ± 0.15	1000	4000	--	--	--
LC	1808	2.00 ± 0.15	1000	4000	--	--	--
LD	1808	0.90 ± 0.10	2500	10000	--	--	--
MA	1632	0.80 ± 0.10	4000	10000	--	--	--

## Soldering Process

All parts incorporate the standard KEMET barrier layer of pure nickel, with an overplate of pure tin to provide excellent solderability as well as resistance to leaching.

HMP solders ,e.g., Pb94, are recommended for high temperature applications.

## Marking

These chips will be supplied unmarked. If required, they can be laser-marked as an extra option. Details on the marking format are included in KEMET Surface Mount catalog F3102.

In general, the information in the KEMET Surface Mount catalog F3102 applies to these capacitors. The information in this bulletin supplements that in the catalog.