



FEATURES

- 75 WATTS MAXIMUM OUTPUT POWER
- SINGLE : OUTPUT CURRENT UP TO 20A
DUAL : TOTAL OUTPUT CURRENT UP TO 15A;
UP TO 100% LOAD IMBALANCE
- COMPACT 2.40 X 2.28 X 0.50 INCH PACKAGE
- HIGH EFFICIENCY UP TO 90%
- INPUT RANGE FROM 36VDC TO 75VDC
- FIXED SWITCHING FREQUENCY (300KHz)
- HALT TESTED
- INDUSTRY STANDARD FOOTPRINT
- ADJUSTABLE OUTPUT VOLTAGE,
INDEPENDENTLY REGULATED OUTPUTS
- INPUT TO OUTPUT ISOLATION (BASIC INSULATION)
- CE MARK MEETS 2006/95/EC, 93/68/EEC AND 2004/108/EC
- SINGLE: UL60950-1, EN60950-1 AND IEC60950-1 LICENSED
- DUAL:DESIGN MEET UL60950-1, EN60950-1 AND IEC60950-1 LICENSED
- ISO9001 CERTIFIED MANUFACTURING FACILITIES
- COMPLIANT TO RoHS EU DIRECTIVE 2002/95/EC

APPLICATIONS

Wireless Network
Telecom/Datacom
Industry Control System
Distributed Power Architectures
Semiconductor Equipment

OPTIONS

Remote on/off, Pin length

DESCRIPTION

HEC75-SERIES DC/DC converters provide up to 75 watts of output power in an industry standard half-brick package and footprint. All models feature a wide input range, trimmable output voltage and a 20A current rating (15A for dual output).

TECHNICAL SPECIFICATION

All specifications are typical at nominal input, full load and 25°C otherwise noted

OUTPUT SPECIFICATIONS		INPUT SPECIFICATIONS	
Output power	75 Watts, max.	Input voltage range	36 – 75VDC
Voltage accuracy	Full load and nominal Vin ± 1.5%	Input filter	L-C type
Minimum load	0%	Input surge voltage 100mS max	100VDC
Voltage adjustability	Single (Note 5) + 10% , -20% Dual + 10% , -10%	Start up time	Nominal Vin and Power up 25mS, typ. constant resistive load Remote ON/OFF 25mS, typ.
Line regulation	LL to HL at FL See table	Input reflected-ripple current	20mAp-p
Load regulation	No Load to Full Load See table	Start-up voltage	34VDC
Remote sense	Single (Note 5) 10% of Vout	Shutdown voltage	32VDC
Ripple and noise 20MHz bandwidth (Note 6)	100mVp-p	Remote ON/OFF (Note 8)	
Temperature coefficient	±0.02% / °C, max.	(Negative logic)	ON=Short or 0V < Vr < 1.2V, IIN=1mA max. OFF=Open or 3V < Vr < 15V, IIN=50µA max.
Transient response recovery time 25% load step change	200µS	(Positive logic)	ON=Open or 3V < Vr < 15V, IIN=50µA max. OFF=Short or 0V < Vr < 1.2V, IIN=1mA max.
Over voltage protection threshold (Non-latching Hiccup)	115% ~ 130% of Vout	Input current of remote control pin	Nominal Vin -0.5mA ~ 0.5mA
Maximum total output current I1 + I2 Dual	15A	Remote off state input current	Nominal Vin 20mA
Over current protection threshold	110% ~ 140% of Iout Rated	ENVIRONMENTAL SPECIFICATIONS	
Short circuit protection	Hiccup, automatics recovery	Operating base-plate temperature range (Note 9)	-40°C to 100°C (with derating)
GENERAL SPECIFICATIONS		Over temperature protection	110°C
Efficiency	See table	Humidity max, Non-condensing	95%
Isolation voltage	Input to Output 1600 VDC, min. Input to Case 1000 VDC, min. Output to Case 1000 VDC, min.	Storage temperature range	-55°C to 125°C
Isolation resistance	10 ⁷ ohms, min.	Thermal shock	MIL-STD-810F
Isolation capacitance	2500 pF, max.	Vibration	MIL-STD-810F
Switching frequency	300 KHz, typ.	EMC CHARACTERISTICS	
Approvals and standard (Note 7)	IEC60950-1, UL60950-1, EN60950-1	EMI (Note 10)	EN55022 Class A
Case material	Open with Aluminum base-plate	Radiated immunity	EN61000-4-3 10 V/m Perf. Criteria A
Weight	Single 63g (2.22oz) Dual 70g (2.47oz)	Fast transient (Note 11)	EN61000-4-4 ± 2KV Perf. Criteria B
MTBF (Note 1)	BELLCORE TR-NWT-000332 Single 2.000 x 10 ⁶ hrs Dual 1.300 x 10 ⁵ hrs MIL-HDBK-217F Single 2.170 x 10 ⁵ hrs Dual 1.080 x 10 ⁵ hrs	Surge (Note 11)	EN61000-4-5 ± 1KV Perf. Criteria B
		Conducted immunity	EN61000-4-6 10 Vr.m.s Perf. Criteria A





Model Number	Input Range	Output Voltage	Output Current		Line Regulation	Load Regulation	Input Current		Eff ⁽⁴⁾ (%)
			Min. load	Full load			No load ⁽³⁾	Full load ⁽²⁾	
HEC75-48S1P8	36 – 75 VDC	1.8 VDC	0mA	20 A	4 mV	6 mV	120mA	0.926 A	85
HEC75-48S2P5	36 – 75 VDC	2.5 VDC	0mA	20 A	5 mV	8 mV	90mA	1.255 A	87
HEC75-48S3P3	36 – 75 VDC	3.3 VDC	0mA	20 A	7 mV	10 mV	120mA	1.618 A	90
HEC75-48S05	36 – 75 VDC	5.0 VDC	0mA	15 A	10 mV	15 mV	130mA	1.838 A	90
HEC75-48S15	36 – 75 VDC	15 VDC	0mA	5 A	30 mV	45 mV	160mA	1.860 A	90

Model Number	Input Range	Output Voltage		Output Current		Line Regulation	Load Regulation	Eff ⁽⁴⁾ (%)
		V1	V2	I 1	I 2			
HEC75-48D3305	36 – 75 VDC	5 VDC	3.3 VDC	15 A	15 A	10/7 mV	15/10 mV	88
HEC75-48D3325	36 – 75 VDC	3.3 VDC	2.5 VDC	15 A	15 A	7/5 mV	10/8 mV	81
HEC75-48D0518	36 – 75 VDC	5 VDC	1.8 VDC	15 A	15 A	10/4 mV	15/6 mV	85
HEC75-48D3318	36 – 75 VDC	3.3 VDC	1.8 VDC	15 A	15 A	7/4 mV	10/6 mV	81

- Note
- BELLCORE TR-NWT-000332. Case 1: 50% Stress, Temperature at Tc=40°C. MIL-HDBK-217F Notice2 @Ta=25 °C, Full load(Ground, Benign, controlled environment).
 - Maximum value at nominal input voltage and full load.
 - Typical value at nominal input voltage and no load.
 - Single : Typical value at nominal input voltage and full load.
Dual : Typical value at nominal input voltage and both outputs current are 7.5A.
 - Maximum output deviation is 10% inclusive of remote sense. If remote sense is not being used, the + sense should be connected to its corresponding +OUTPUT and likewise the -sense should be connected to its corresponding –OUTPUT.
 - Measured with a 1µF M/C and a 10µF M/C(for dual outputs) or 1µF M/C and a 10µF T/C(for single outputs)
 - Dual output safety approvals pending.
 - The negative / positive logic and pin length are optional. The pin voltage is referenced to -Vin.
Single : Please see single output product options table.
Dual : Please see dual output product options table.
 - Heat sink is optional and P/N: 7G-0021A-F, 7G-0022A-F, 7G-0023A-F, 7G-0024A-F.
 - The HEC75 meets EN55022 class A and class B only with external components connected with the input pins of the converter.
 - An external input filter capacitor is required if the module has to meet EN61000-4-4, EN61000-4-5.
The filter capacitor Power Mate suggest: Nippon chemi-con KY series, 220µF/100V, ESR 48mΩ.
 - BASEPLATE GROUNDING : Base-plate should be grounded at one of the four screw bolts prior to operation.
 - The converter is provided by basic insulation.





Single Output :

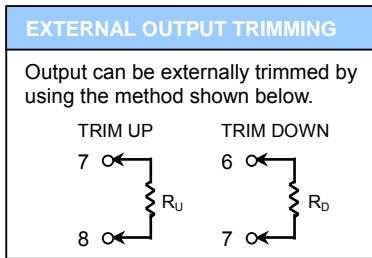
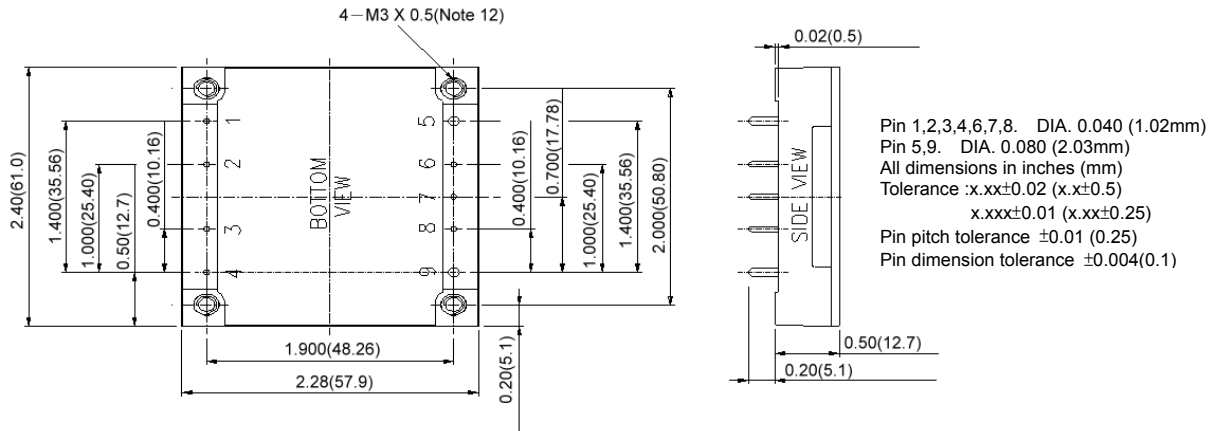

PIN CONNECTION		
PIN	Define	Diameter
1	- INPUT	0.04 Inches
2	CASE	0.04 Inches
3	CTRL	0.04 Inches
4	+ INPUT	0.04 Inches
5	- OUTPUT	0.08 Inches
6	- SENSE	0.04 Inches
7	TRIM	0.04 Inches
8	+ SENSE	0.04 Inches
9	+ OUTPUT	0.08 Inches

PRODUCT OPTIONS TABLE	
Option	Suffix
Negative remote ON/OFF logic, 0.20" pin length (standard)	-
Negative remote ON/OFF logic, 0.145" pin length	-L
Negative remote ON/OFF logic, 0.11" pin length	-K
Positive remote ON/OFF logic, 0.20" pin length	-P
Positive remote ON/OFF logic, 0.145" pin length	-S
Positive remote ON/OFF logic, 0.11" pin length	-M

Example : HEC75-48S3P-3

Dual Output :

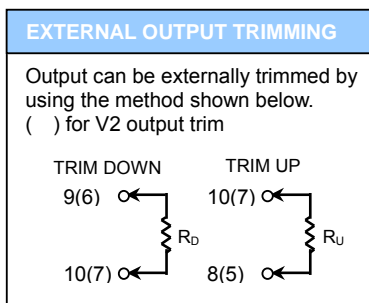
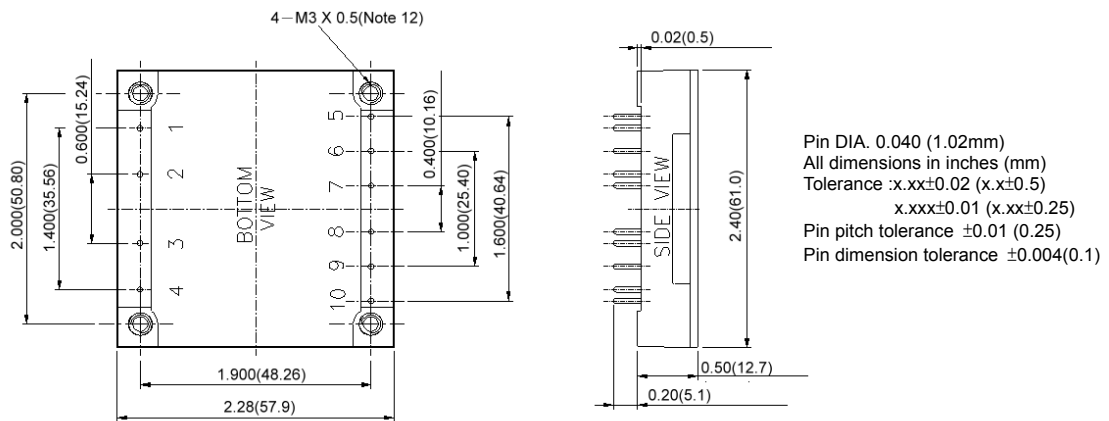

PIN CONNECTION		
PIN	Define	Diameter
1	- INPUT	0.04 Inches
2	CASE	0.04 Inches
3	CTRL	0.04 Inches
4	+ INPUT	0.04 Inches
5	+ V2	0.04 Inches
6	-V2 (COM)	0.04 Inches
7	V2 TRIM	0.04 Inches
8	+V1	0.04 Inches
9	-V1 (COM)	0.04 Inches
10	V1 TRIM	0.04 Inches

PRODUCT OPTIONS TABLE	
Option	Suffix
Positive remote ON/OFF logic, 0.20" pin length (standard)	-
Positive remote ON/OFF logic, 0.145" pin length	-L
Positive remote ON/OFF logic, 0.11" pin length	-K
Negative remote ON/OFF logic, 0.20" pin length	-N
Negative remote ON/OFF logic, 0.145" pin length	-S
Negative remote ON/OFF logic, 0.11" pin length	-M

Example : HEC75-48D3305-N





75WATTS SINGLE/DUAL OUTPUT DC-DC CONVERTER

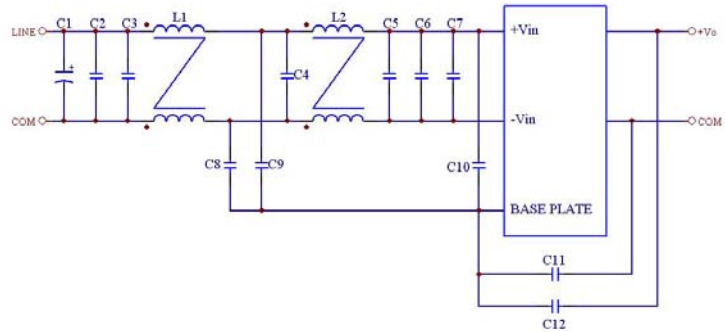
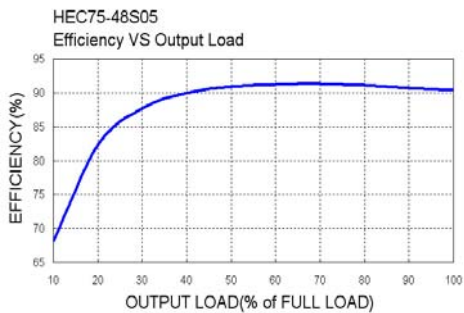
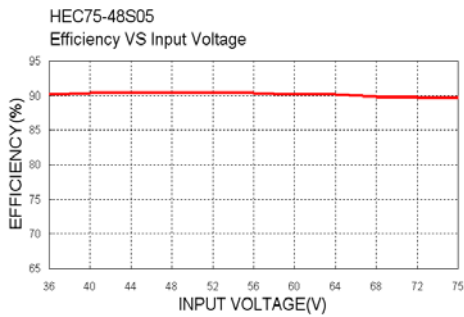
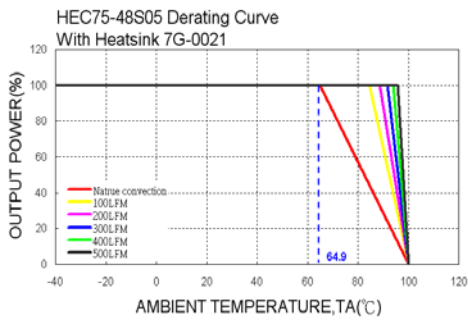
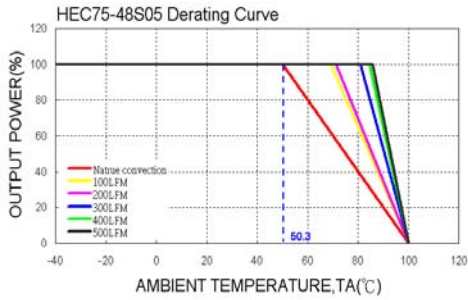

Recommended Filter for EN55022 Class B Compliance

The components used in the above figure, together with the manufacturers' part numbers for these components, are as follows:

	C1	C2	C3	C4	C5
HEC75-xxx	220μF/100V	2.2μF /100V	2.2μF /100V	2.2μF /100V	100μF/100V
	C6	C7	C8	C9	C10
	2.2μF /100V	2.2μF /100V	1.5nF /3KV	1.5nF /3KV	1.5nF /3KV
	C11	C12	L1	L2	
	1.5nF /3KV	1.5nF /3KV	1400.4μH	304.98μH	

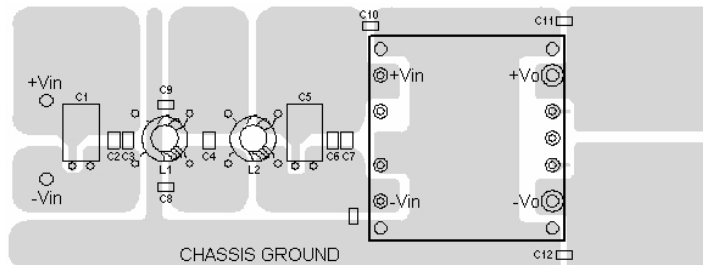

Recommended EN55022 Class B Filter Circuit Layout

