

## Features

- Attenuation: 1 dB Steps to 15 dB
- Low DC Power Consumption
- Small Footprint, JEDEC Package
- Integral TTL Driver
- 50 Ohm Impedance
- Test Boards Available
- Tape and Reel Packaging Available
- Lead-Free CSP-1 Package
- 100% Matte Tin Plating over Copper
- Halogen-Free “Green” Mold Compound
- 260°C Reflow Compatible
- RoHS\* Compliant Version of AT90-0413

## Description

M/A-COM’s MAADCC0006 is a GaAs FET 4-Bit digital attenuator with integral driver. Step size is 1 dB providing a 15 dB attenuation range. This device is in an PQFN plastic surface mount package. The MAADCC0006 is suited for applications where accuracy, fast speed, low power consumption and low costs are required.

## Schematic with Off-Chip Components

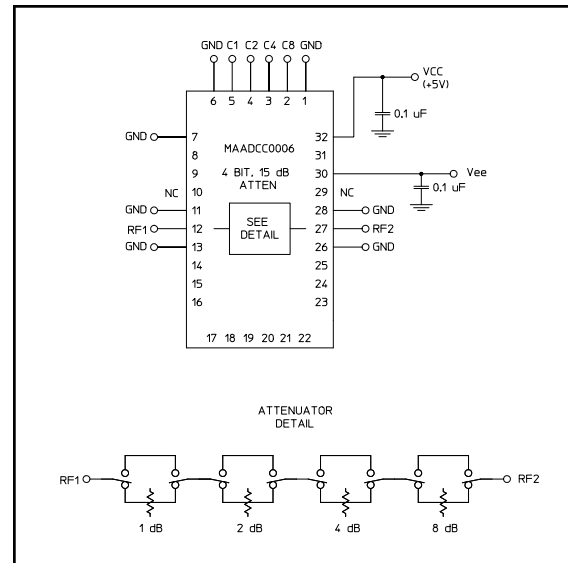

## Pin Configuration<sup>2</sup>

Pin No.	Function	Pin No.	Function
1	GND	17	N/C
2	C8	18	N/C
3	C4	19	N/C
4	C2	20	N/C
5	C1	21	N/C
6	GND	22	N/C
7	GND	23	N/C
8	N/C	24	N/C
9	N/C	25	N/C
10	N/C <sup>1</sup>	26	GND
11	GND	27	RF2
12	RF1	28	GND
13	GND	29	N/C <sup>1</sup>
14	N/C	30	Vee
15	N/C	31	N/C
16	N/C	32	+Vcc

1. Pins 10 & 29 must be isolated.
2. The exposed pad centered on the package bottom must be connected to RF and DC ground. (For PQFN Packages)

## Ordering Information

Part Number	Package
MAADCC0006	Bulk Packaging
MAADCC0006TR	1000 piece reel
MAADCC0006-TB	Sample Test Board

Note: Reference Application Note M513 for reel size information.

\* Restrictions on Hazardous Substances, European Union Directive 2002/95/EC.

**ADVANCED:** Data Sheets contain information regarding a product M/A-COM Technology Solutions is considering for development. Performance is based on target specifications, simulated results, and/or prototype measurements. Commitment to develop is not guaranteed.  
**PRELIMINARY:** Data Sheets contain information regarding a product M/A-COM Technology Solutions has under development. Performance is based on engineering tests. Specifications are typical. Mechanical outline has been fixed. Engineering samples and/or test data may be available. Commitment to produce in volume is not guaranteed.

• **North America** Tel: 800.366.2266 • **Europe** Tel: +353.21.244.6400  
 • **India** Tel: +91.80.4155721 • **China** Tel: +86.21.2407.1588  
 Visit [www.macomtech.com](http://www.macomtech.com) for additional data sheets and product information.

M/A-COM Technology Solutions Inc. and its affiliates reserve the right to make changes to the product(s) or information contained herein without notice.

## Digital Attenuator 15.0 dB, 4-Bit, TTL Driver, DC-4.0 GHz

Rev. V5

### Electrical Specifications: $T_A = 25^\circ\text{C}$

Parameter	Test Conditions	Frequency	Units	Min	Typ	Max
Insertion Loss	—	DC-2.5 GHz	dB	—	2.0	2.5
		DC-4.0 GHz	dB	—	2.5	3.0
Attenuation Accuracy	Individual Bits or Combination of Bits	DC-2.5 GHz	dB	—	—	$\pm(0.3+4\%$ of atten setting)
		DC-4.0 GHz	dB	—	—	$\pm(0.3+6\%$ of atten setting)
VSWR	Full Attenuation Range	DC-2.5 GHz	Ratio	—	1.5:1	1.8:1
		DC-4.0 GHz	Ratio	—	1.8:1	2.0:1
Switching Speed	50% Cntl to 90%/10% RF 10% to 90% or 90% to 10%	—	ns	—	25	—
		—	ns	—	4	—
1 dB Compression	—	50 MHz	dB	—	+21	—
		0.5-4.0 GHz	dB	—	+27	—
Input $IP_3$	Two-tone Inputs up to +5 dBm	50 MHz	dB	—	+35	—
		0.5-4.0 GHz	dB	—	+48	—
+Vcc	—	—	V	4.75	5.0	5.25
-Vee	—	—	V	-8.0	-5.0	-4.75
$V_{IL}$ $V_{IH}$	LOW-level input voltage HIGH-level input voltage	—	V	0.0	—	0.8
		—	V	2.0	—	5.0
$I_{in}$ (Input Leakage Current)	$V_{in} = V_{CC}$ or GND	—	$\mu\text{A}$	-1.0	—	1.0
$I_{cc}$ (Quiescent Supply Current)	$V_{cntrl} = V_{CC}$ or GND	—	$\mu\text{A}$	—	250	400
$\Delta I_{cc}$ (Additional Supply Current Per TTL Input Pin)	$V_{CC} = \text{Max}$ , $V_{cntrl} = V_{CC} - 2.1\text{ V}$	—	mA	—	—	1.5
IEE	$V_{EE}$ min to max, $V_{in} = V_{IL}$ or $V_{IH}$	—	mA	-1.0	-0.2	—
Thermal Resistance $\theta_{jc}$	—	—	$^\circ\text{C/W}$	—	15	—

### Absolute Maximum Ratings<sup>3,4</sup>

Parameter	Absolute Maximum
Max. Input Power 0.05 GHz 0.5 - 4.0 GHz	+27 dBm +34 dBm
$V_{CC}$	$-0.5\text{ V} \leq V_{CC} \leq +7.0\text{ V}$
$V_{EE}$	$-8.5\text{ V} \leq V_{EE} \leq +0.5\text{ V}$
$V_{CC} - V_{EE}$	$-0.5\text{ V} \leq V_{CC} - V_{EE} \leq 14.5\text{ V}$
$V_{in}^5$	$-0.5\text{ V} \leq V_{in} \leq V_{CC} + 0.5\text{ V}$
Operating Temperature	$-40^\circ\text{C}$ to $+85^\circ\text{C}$
Storage Temperature	$-65^\circ\text{C}$ to $+125^\circ\text{C}$

- Exceeding any one or combination of these limits may cause permanent damage to this device.
- M/A-COM does not recommend sustained operation near these survivability limits.
- Standard CMOS TTL interface, latch-up will occur if logic signal applied prior to power supply.

### Recommended PCB Configuration<sup>6</sup>

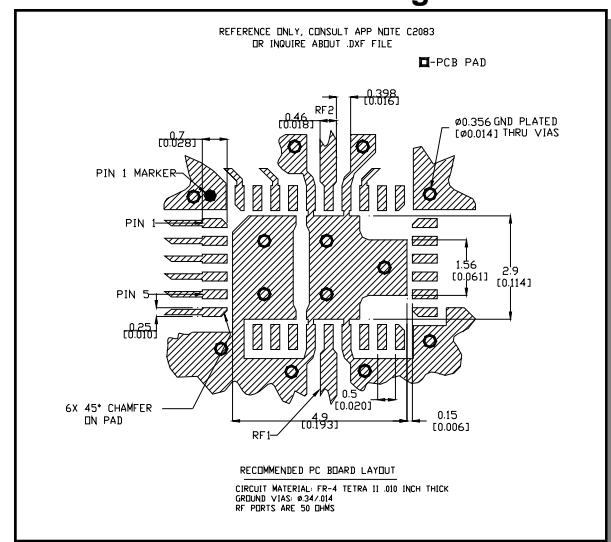

6. Application Note S2083 is available on line at [www.macom.com](http://www.macom.com)

2

**ADVANCED:** Data Sheets contain information regarding a product M/A-COM Technology Solutions is considering for development. Performance is based on target specifications, simulated results, and/or prototype measurements. Commitment to develop is not guaranteed.  
**PRELIMINARY:** Data Sheets contain information regarding a product M/A-COM Technology Solutions has under development. Performance is based on engineering tests. Specifications are typical. Mechanical outline has been fixed. Engineering samples and/or test data may be available. Commitment to produce in volume is not guaranteed.

• North America Tel: 800.366.2266 • Europe Tel: +353.21.244.6400  
 • India Tel: +91.80.4155721 • China Tel: +86.21.2407.1588  
 Visit [www.macomtech.com](http://www.macomtech.com) for additional data sheets and product information.

M/A-COM Technology Solutions Inc. and its affiliates reserve the right to make changes to the product(s) or information contained herein without notice.

## Handling Procedures

Please observe the following precautions to avoid damage:

## Static Sensitivity

Gallium Arsenide Integrated Circuits are sensitive to electrostatic discharge (ESD) and can be damaged by static electricity. Proper ESD control techniques should be used when handling these devices.

## Moisture Sensitivity

The MSL rating for this part is defined as Level 2 per IPC/JEDEC J-STD-020. Parts shall be stored and/or baked as required for MSL Level 2 parts.

## Truth Table (Digital Attenuator)

C8	C4	C2	C1	Attenuation
0	0	0	0	Loss, Reference
0	0	0	1	1.0 dB
0	0	1	0	2.0 dB
0	1	0	0	4.0 dB
1	0	0	0	8.0 dB
1	1	1	1	15.0 dB

0 = TTL Low. 1 = TTL High

## Typical Performance Curves

Reference Loss vs. Frequency

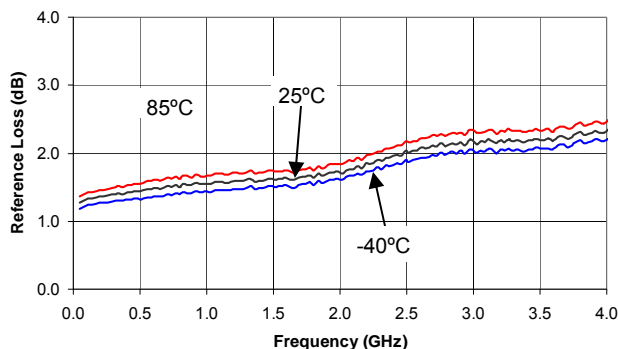

Attenuation - 1 dB Bit vs. Frequency

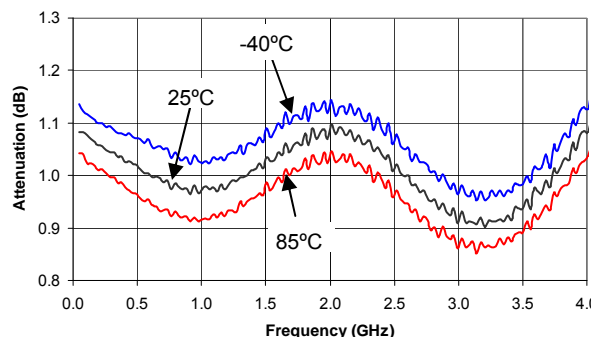

Attenuation - 2 dB Bit vs. Frequency

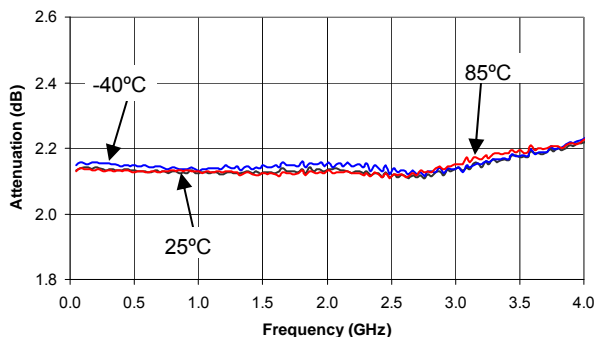

Attenuation - 4dB Bit vs. Frequency

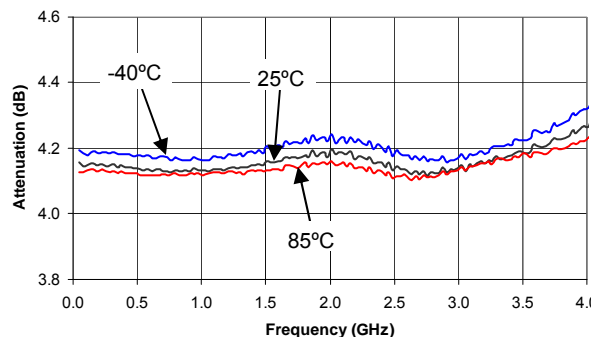

## Typical Performance Curves

Attenuation - 8 dB Bit vs. Frequency

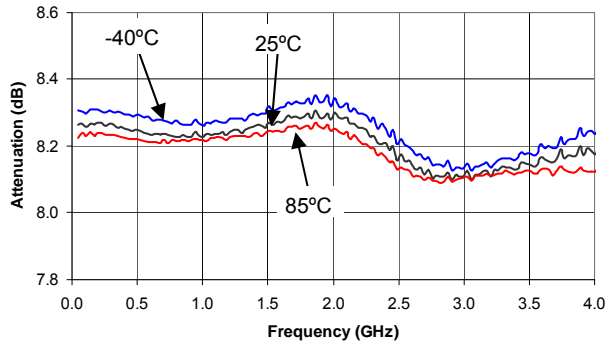

Attenuation - 15 dB Attenuation vs. Frequency

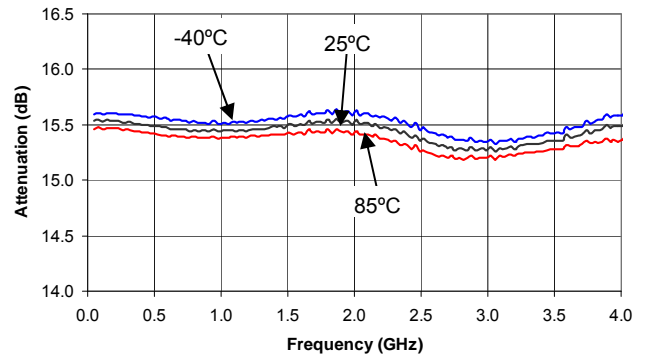

VSWR vs. Frequency  
Reference Loss State

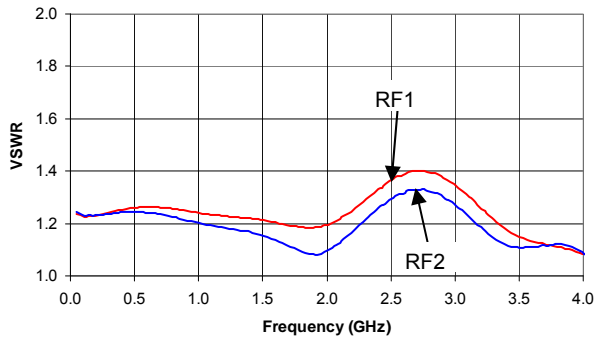

VSWR - 1 dB Bit vs. Frequency

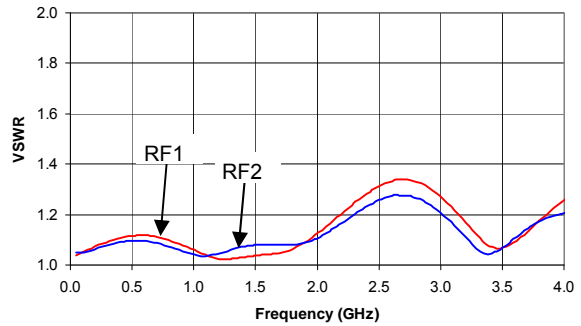

VSWR - 2 dB Bit vs. Frequency

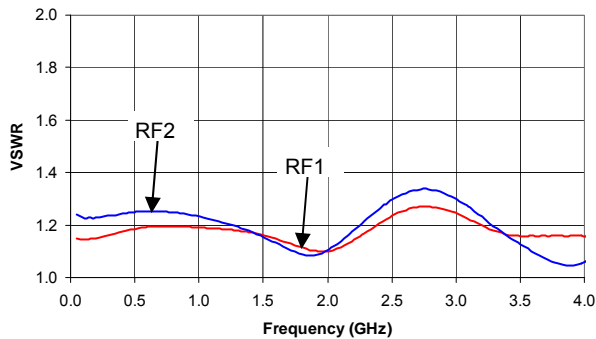

VSWR - 4 dB Bit vs. Frequency

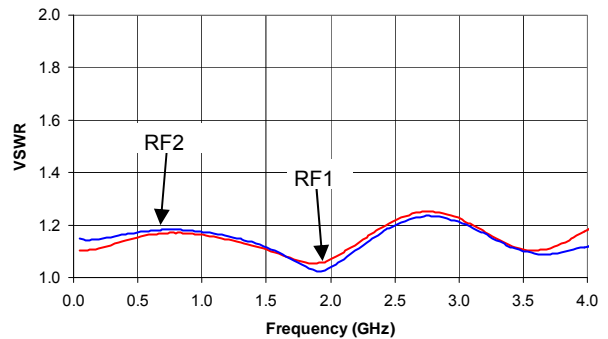

## Typical Performance Curves

VSWR - 8 dB Bit vs. Frequency

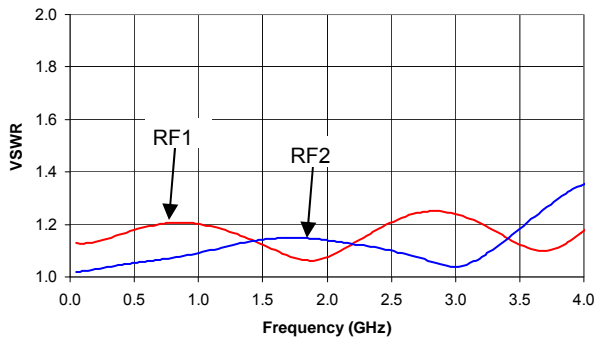

VSWR - 15 dB Attenuation vs. Frequency

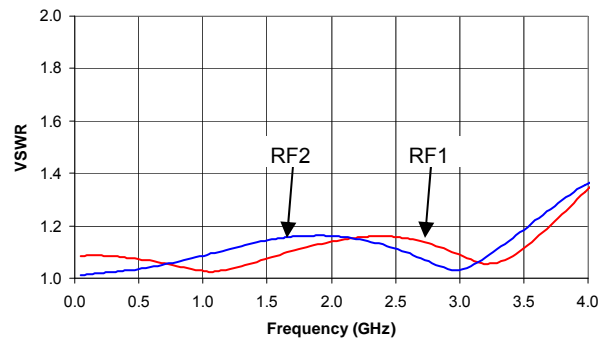

## CSP-1, Lead-Free 4 x 6 mm, 32-lead PQFN†

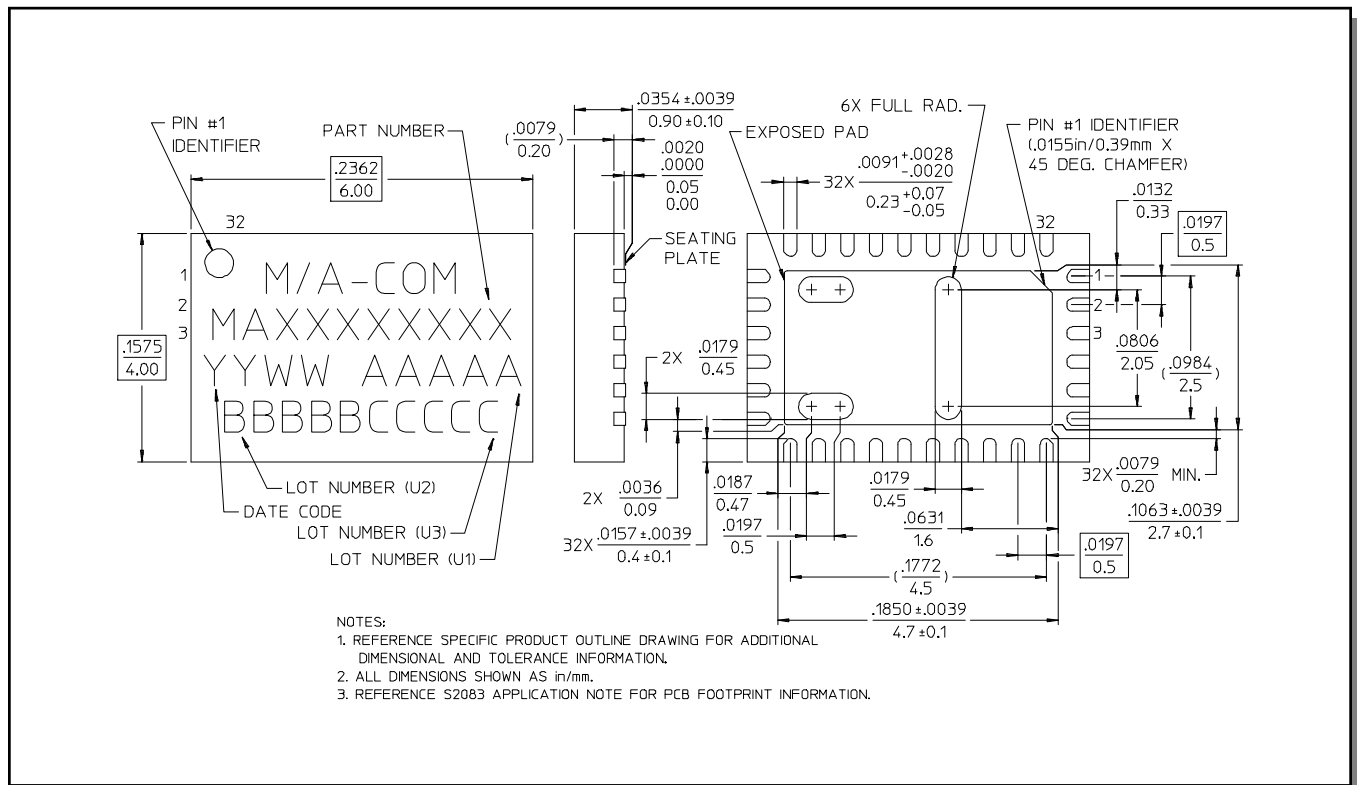

† Reference Application Note M538 for lead-free solder reflow recommendations.