

Agency Approvals

AGENCY	AGENCY FILE NUMBER
	E230531

Maximum Ratings and Thermal Characteristics (T_A=25°C unless otherwise noted)

Parameter	Symbol	Value	Unit
Peak Pulse Power Dissipation at T _A =25°C by 10x1000µs waveform (Fig.1)(Note 1), (Note 2)	P _{PPM}	3000	W
Power Dissipation on infinite heat sink at T _A =50°C	P _{M(AV)}	6.5	W
Peak Forward Surge Current, 8.3ms Single Half Sine Wave (Note 3)	I _{FSM}	300	A
Maximum Instantaneous Forward Voltage at 100A for Unidirectional only	V _F	3.5	V
Operating Junction and Storage Temperature Range	T _J , T _{STG}	-65 to 150	°C
Typical Thermal Resistance Junction to Lead	R _{θJL}	15	°C/W
Typical Thermal Resistance Junction to Ambient	R _{θJA}	75	°C/W

Notes:

1. Non-repetitive current pulse, per Fig. 3 and derated above T_A = 25°C per Fig. 2.
2. Mounted on copper pad area of 0.31x0.31" (8.0 x 8.0mm) to each terminal.
3. Measured on 8.3ms single half sine wave or equivalent square wave for unidirectional device only, duty cycle=4 per minute maximum.

Description

The SMDJ series is designed specifically to protect sensitive electronic equipment from voltage transients induced by lightning and other transient voltage events.

Features

- Halogen-Free
- RoHS compliant
- For surface mounted applications in order to optimize board space
- Low profile package
- Built-in strain relief
- Typical maximum temperature coefficient
 $\Delta V_{BR} = 0.1\% \times V_{BR}@25^\circ\text{C} \times \Delta T$
- Glass passivated chip junction
- 3000W peak pulse power capability at 10x1000µs waveform, repetition rate (duty cycles):0.01 %
- Fast response time: typically less than 1.0ps from 0V to BV min
- Excellent clamping capability
- Low incremental surge resistance
- Typical I_R less than 2µA above 12V
- High Temperature soldering guaranteed: 260°C/40 seconds at terminals
- Plastic package has Underwriters Laboratory Flammability 94V-O
- Matte Tin Lead-free Plated

Applications

TVS devices are ideal for the protection of I/O Interfaces, V_{CC} bus and other vulnerable circuits used in Telecom, Computer, Industrial and Consumer electronic applications.

Electrical Characteristics

Part Number (Uni)	Part Number (Bi)	Marking		Reverse Stand off Voltage V_R (Volts)	Breakdown Voltage V_{BR} (Volts) @ I_T		Test Current I_T (mA)	Maximum Clamping Voltage V_C @ I_{PP} (V)	Maximum Peak Pulse Current I_{PP} (A)	Maximum Reverse Leakage I_R @ V_R (μ A)	Agency Approval 
		UNI	BI		MIN	MAX					
SMDJ5.0A	SMDJ5.0CA	RDE	DDE	5.0	6.40	7.00	10	9.2	326.1	800	X
SMDJ6.0A	SMDJ6.0CA	RDG	DDG	6.0	6.67	7.37	10	10.3	291.3	800	X
SMDJ6.5A	SMDJ6.5CA	RDK	DDK	6.5	7.22	7.98	10	11.2	267.9	500	X
SMDJ7.0A	SMDJ7.0CA	PDM	DDM	7.0	7.78	8.60	10	12.0	250.0	200	X
SMDJ7.5A	SMDJ7.5CA	PDP	DDP	7.5	8.33	9.21	1	12.9	232.6	100	X
SMDJ8.0A	SMDJ8.0CA	PDR	DDR	8.0	8.89	9.83	1	13.6	220.6	50	X
SMDJ8.5A	SMDJ8.5CA	PDT	DDT	8.5	9.44	10.40	1	14.4	208.3	20	X
SMDJ9.0A	SMDJ9.0CA	PDV	DDV	9.0	10.00	11.10	1	15.4	194.8	10	X
SMDJ10A	SMDJ10CA	PDX	DDX	10.0	11.10	12.30	1	17.0	176.5	5	X
SMDJ11A	SMDJ11CA	PDZ	DDZ	11.0	12.20	13.50	1	18.2	164.8	2	X
SMDJ12A	SMDJ12CA	PEE	DEE	12.0	13.30	14.70	1	19.9	150.8	2	X
SMDJ13A	SMDJ13CA	PEG	DEG	13.0	14.40	15.90	1	21.5	139.5	2	X
SMDJ14A	SMDJ14CA	PEK	DEK	14.0	15.60	17.20	1	23.2	129.3	2	X
SMDJ15A	SMDJ15CA	PEM	DEM	15.0	16.70	18.50	1	24.4	123.0	2	X
SMDJ16A	SMDJ16CA	PEP	DEP	16.0	17.80	19.70	1	26.0	115.4	2	X
SMDJ17A	SMDJ17CA	PER	DER	17.0	18.90	20.90	1	27.6	108.7	2	X
SMDJ18A	SMDJ18CA	PET	DET	18.0	20.00	22.10	1	29.2	102.7	2	X
SMDJ20A	SMDJ20CA	PEV	DEV	20.0	22.20	24.50	1	32.4	92.6	2	X
SMDJ22A	SMDJ22CA	PEX	DEX	22.0	24.40	26.90	1	35.5	84.5	2	X
SMDJ24A	SMDJ24CA	PEZ	DEZ	24.0	26.70	29.50	1	38.9	77.1	2	X
SMDJ26A	SMDJ26CA	PFE	DFE	26.0	28.90	31.90	1	42.1	71.3	2	X
SMDJ28A	SMDJ28CA	PFG	DFG	28.0	31.10	34.40	1	45.4	66.1	2	X
SMDJ30A	SMDJ30CA	PFK	DFK	30.0	33.30	36.80	1	48.4	62.0	2	X
SMDJ33A	SMDJ33CA	PFM	DFM	33.0	36.70	40.60	1	53.3	56.3	2	X
SMDJ36A	SMDJ36CA	PFP	DFP	36.0	40.00	44.20	1	58.1	51.6	2	X
SMDJ40A	SMDJ40CA	PFR	DFR	40.0	44.40	49.10	1	64.5	46.5	2	X
SMDJ43A	SMDJ43CA	PFT	DFT	43.0	47.80	52.80	1	69.4	43.2	2	X
SMDJ45A	SMDJ45CA	PFV	DFV	45.0	50.00	55.30	1	72.7	41.3	2	X
SMDJ48A	SMDJ48CA	PFX	DFX	48.0	53.30	58.90	1	77.4	38.8	2	X
SMDJ51A	SMDJ51CA	PFZ	DFZ	51.0	56.70	62.70	1	82.4	36.4	2	X
SMDJ54A	SMDJ54CA	RGE	DGE	54.0	60.00	66.30	1	87.1	34.4	2	X
SMDJ58A	SMDJ58CA	PGG	DGG	58.0	64.40	71.20	1	93.6	32.1	2	X
SMDJ60A	SMDJ60CA	PGK	DGK	60.0	66.70	73.70	1	96.8	31.0	2	X
SMDJ64A	SMDJ64CA	PGM	DGM	64.0	71.10	78.60	1	103.0	29.1	2	X
SMDJ70A	SMDJ70CA	PGP	DGP	70.0	77.80	86.00	1	113.0	26.5	2	X
SMDJ75A	SMDJ75CA	PGR	DGR	75.0	83.30	92.10	1	121.0	24.8	2	X
SMDJ78A	SMDJ78CA	PGT	DGT	78.0	86.70	95.80	1	126.0	23.8	2	X
SMDJ85A	SMDJ85CA	PGV	DGV	85.0	94.40	104.00	1	137.0	21.9	2	X
SMDJ90A	SMDJ90CA	PGX	DGX	90.0	100.00	111.00	1	146.0	20.5	2	X
SMDJ100A	SMDJ100CA	PGZ	DGZ	100.0	111.00	123.00	1	162.0	18.5	2	X
SMDJ110A	SMDJ110CA	PHE	DHE	110.0	122.00	135.00	1	177.0	16.9	2	X
SMDJ120A	SMDJ120CA	PHG	DHG	120.0	133.00	147.00	1	193.0	15.5	2	X
SMDJ130A	SMDJ130CA	PHK	DHK	130.0	144.00	159.00	1	209.0	14.4	2	X
SMDJ150A	SMDJ150CA	PHM	DHM	150.0	167.00	185.00	1	243.0	12.3	2	X
SMDJ160A	SMDJ160CA	PHP	DHP	160.0	178.00	197.00	1	259.0	11.6	2	X
SMDJ170A	SMDJ170CA	PHR	DHR	170.0	189.00	209.00	1	275.0	10.9	2	X

For parts without A, the V_{BR} is $\pm 10\%$, and V_C is 5% higher than A parts.

For bidirectional type having V_R of 10 volts and less, the I_R limit is double.

Ratings and Characteristic Curves ($T_A=25^\circ\text{C}$ unless otherwise noted)

Figure 1 - Peak Pulse Power Rating Curve

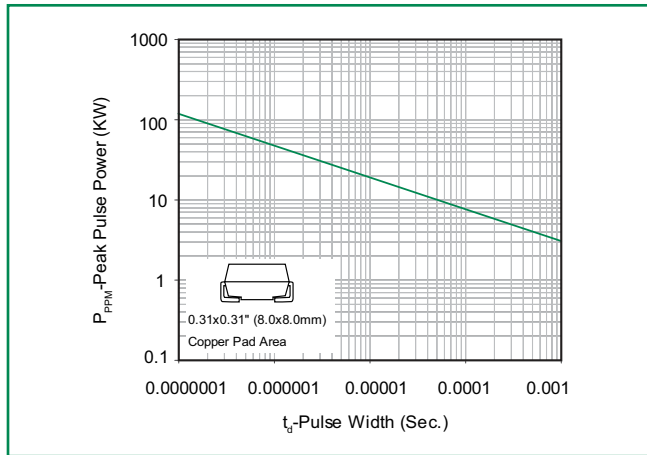

Figure 2 - Pulse Derating Curve

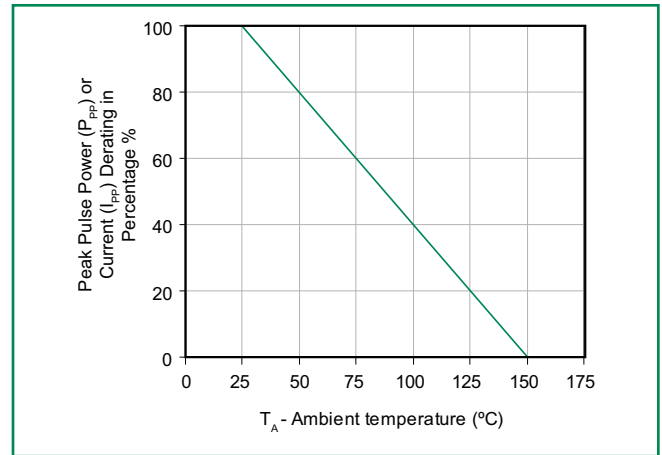

Figure 3 - Pulse Waveform

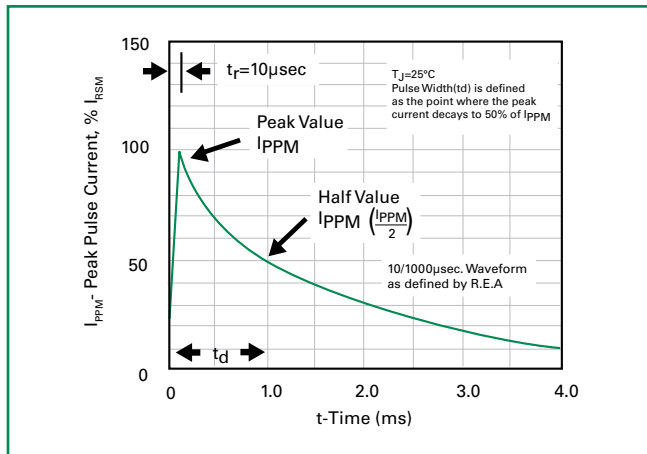

Figure 4 - Typical Junction Capacitance

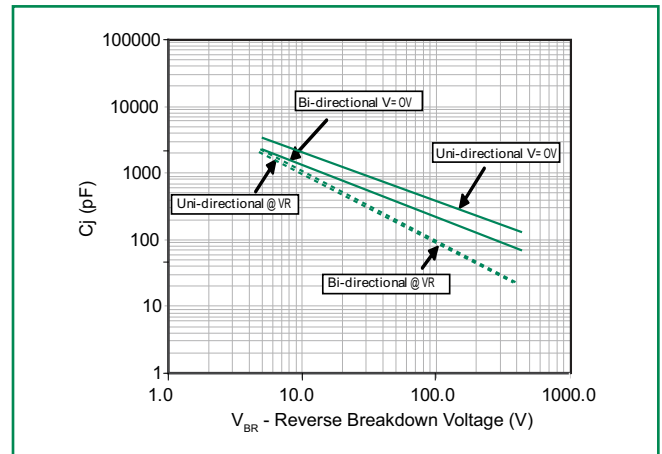

Figure 5 - Steady State Power Derating Curve

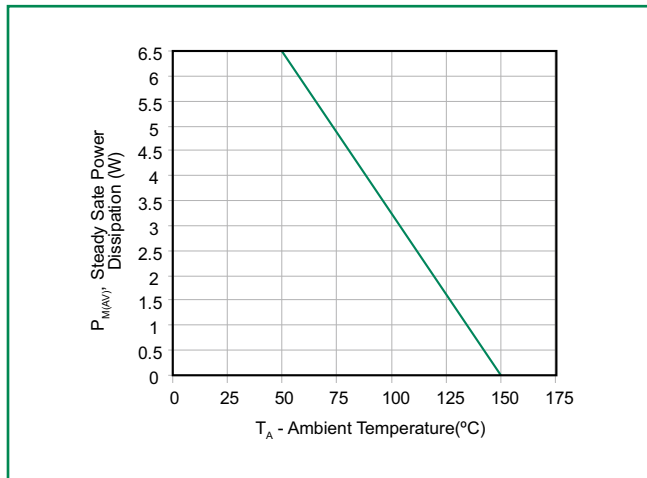
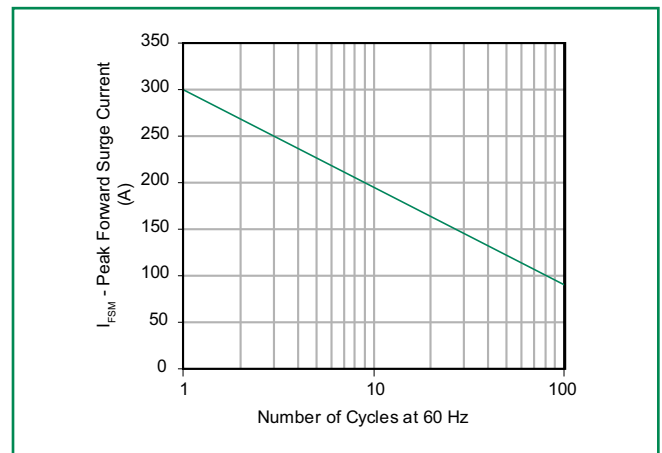
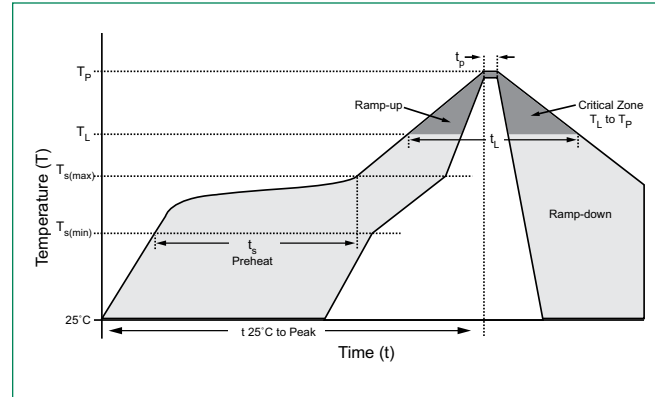

Figure 6 - Maximum Non-Repetitive Peak Forward Surge Current Uni-Directional only



Soldering Parameters

Reflow Condition		Lead-free assembly
Pre Heat	- Temperature Min ($T_{s(min)}$)	150°C
	- Temperature Max ($T_{s(max)}$)	200°C
	- Time (min to max) (t_s)	60 – 180 secs
Average ramp up rate (Liquidus Temp (T_L) to peak)		3°C/second max
$T_{s(max)}$ to T_L - Ramp-up Rate		3°C/second max
Reflow	- Temperature (T_L) (Liquidus)	217°C
	- Time (min to max) (t_s)	60 – 150 seconds
Peak Temperature (T_p)		260 ^{+0/-5} °C
Time within 5°C of actual peak Temperature (t_p)		20 – 40 seconds
Ramp-down Rate		6°C/second max
Time 25°C to peak Temperature (T_p)		8 minutes Max.
Do not exceed		280°C



Physical Specifications

Weight	0.007 ounce, 0.21 grams
Case	JEDEC DO214AB. Molded plastic body over glass passivated junction
Polarity	Color band denotes positive end (cathode) except Bidirectional.
Terminal	Matte Tin-plated leads, Solderable per JESD22-B102D

Environmental Specifications

Temperature Cycle	JESD22-A104
Pressure Cooker	JESD 22-A102
High Temp. Storage	JESD22-A103
HTRB	JESD22-A108
Thermal Shock	JESD22-A106

Dimensions

DO-214AB (SMC J-Bend)

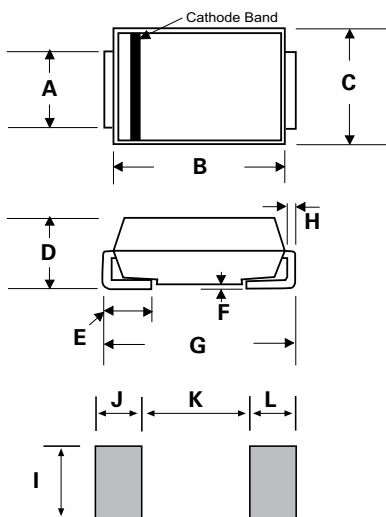

Dimensions	Inches		Millimeters	
	Min	Max	Min	Max
A	0.114	0.126	2.900	3.200
B	0.260	0.280	6.600	7.110
C	0.220	0.245	5.590	6.220
D	0.079	0.103	2.060	2.620
E	0.030	0.060	0.760	1.520
F	-	0.008	-	0.203
G	0.305	0.320	7.750	8.130
H	0.006	0.012	0.152	0.305
I	0.129	-	3.300	-
J	0.094	-	2.400	-
K	-	0.165	-	4.200
L	0.094	-	2.400	-

Part Numbering System

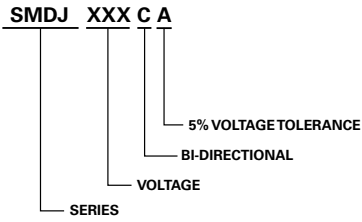

Part Marking System

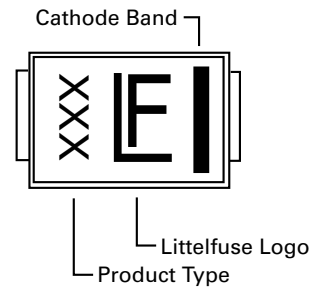

Packaging

Part number	Component Package	Quantity	Packaging Option	Packaging Specification
SMDJxxxXX	DO-214AB	3000	Tape & Reel – 16mm/13" tape	EIA STD RS-481

SMDJ Series