

Agency Approvals

AGENCY	AGENCY FILE NUMBER
	E230531

Maximum Ratings and Thermal Characteristics (T_A=25°C unless otherwise noted)

Parameter	Symbol	Value	Unit
Peak Pulse Power Dissipation by 10x1000µs test waveform (Fig.1) (Note 1)	P _{PPM}	3000	W
Steady State Power Dissipation on infinite heat sink at T _L =75°C (Fig. 5)	P _D	7.0	W
Peak Forward Surge Current, 8.3ms Single Half Sine Wave Unidirectional only (Note 2)	I _{FSM}	300	A
Maximum Instantaneous Forward Voltage at 100A for Unidirectional only (Note 3)	V _F	3.5/5.0	V
Operating Junction and Storage Temperature Range	T _J , T _{STG}	-55 to 175	°C
Typical Thermal Resistance Junction to Lead	R _{WJL}	8.0	°C/W
Typical Thermal Resistance Junction to Ambient	R _{WJA}	40	°C/W

Notes:

1. Non-repetitive current pulse, per Fig. 3 and derated above T_A = 25°C per Fig. 2.
2. Measured on 8.3ms single half sine wave or equivalent square wave, duty cycle=4 per minute maximum.
3. V_F<3.5V for devices of V_{BR} ≤ 200V and V_F<5.0V for devices of V_{BR} ≥ 201V.

Description

The 3KP Series is designed specifically to protect sensitive electronic equipment from voltage transients induced by lightning and other transient voltage events.

Features

- Halogen-Free
- RoHS compliant
- Typical maximum temperature coefficient
 $\Delta V_{BR} = 0.1\% \times V_{BR} @ 25^\circ\text{C} \times \Delta T$
- Glass passivated chip junction in P600 package
- 3000W peak pulse capability at 10x1000µs waveform, repetition rate (duty cycles):0.01%
- Fast response time: typically less than 1.0ps from 0 Volts to BV min
- Excellent clamping capability
- Low incremental surge resistance
- Typical I_R less than 2µA above 12V
- High temperature soldering guaranteed: 260°C/40 seconds / 0.375" (9.5mm) lead length, 5 lbs., (2.3kg) tension
- Plastic package has Underwriters Laboratory Flammability classification 94V-O
- Matte Tin Lead-free plated

Applications

TVS devices are ideal for the protection of I/O interfaces, V_{CC} bus and other vulnerable circuits used in telecom, computer, industrial and consumer electronic applications.

Transient Voltage Suppression Diodes

Axial Leaded – 3000W > 3KP series

Electrical Characteristics

Part Number (Uni)	Part Number (Bi)	Reverse Stand off Voltage V_R (Volts)	Breakdown Voltage V_{BR} (Volts) @ I_T		Test Current I_T (mA)	Maximum Clamping Voltage V_C @ I_{PP} (V)	Maximum Peak Pulse Current I_{PP} (A)	Maximum Reverse Leakage I_R @ V_R (μ A)	Agency Approval 
			MIN	MAX					
3KP5.0A	3KP5.0CA	5.0	6.40	7.00	50	9.2	326.1	5000	X
3KP6.0A	3KP6.0CA	6.0	6.67	7.37	50	10.3	291.3	5000	X
3KP6.5A	3KP6.5CA	6.5	7.22	7.98	50	11.2	267.9	2000	X
3KP7.0A	3KP7.0CA	7.0	7.78	8.60	50	12.0	250.0	1000	X
3KP7.5A	3KP7.5CA	7.5	8.33	9.21	5	12.9	232.6	250	X
3KP8.0A	3KP8.0CA	8.0	8.89	9.83	5	13.6	220.6	150	X
3KP8.5A	3KP8.5CA	8.5	9.44	10.40	5	14.4	208.3	50	X
3KP9.0A	3KP9.0CA	9.0	10.00	11.10	5	15.4	194.8	20	X
3KP10A	3KP10CA	10.0	11.10	12.30	5	17.0	176.5	15	X
3KP11A	3KP11CA	11.0	12.20	13.50	5	18.2	164.8	2	X
3KP12A	3KP12CA	12.0	13.30	14.70	5	19.9	150.8	2	X
3KP13A	3KP13CA	13.0	14.40	15.90	5	21.5	139.5	2	X
3KP14A	3KP14CA	14.0	15.60	17.20	5	23.2	129.3	2	X
3KP15A	3KP15CA	15.0	16.70	18.50	5	24.4	123.0	2	X
3KP16A	3KP16CA	16.0	17.80	19.70	5	26.0	115.4	2	X
3KP17A	3KP17CA	17.0	18.90	20.90	5	27.6	108.7	2	X
3KP18A	3KP18CA	18.0	20.00	22.10	5	29.2	102.7	2	X
3KP20A	3KP20CA	20.0	22.20	24.50	5	32.4	92.6	2	X
3KP22A	3KP22CA	22.0	24.40	26.90	5	35.5	84.5	2	X
3KP24A	3KP24CA	24.0	26.70	29.50	5	38.9	77.1	2	X
3KP26A	3KP26CA	26.0	28.90	31.90	5	42.1	71.3	2	X
3KP28A	3KP28CA	28.0	31.10	34.40	5	45.4	66.1	2	X
3KP30A	3KP30CA	30.0	33.30	36.80	5	48.4	62.0	2	X
3KP33A	3KP33CA	33.0	36.70	40.60	5	53.3	56.3	2	X
3KP36A	3KP36CA	36.0	40.00	44.20	5	58.1	51.6	2	X
3KP40A	3KP40CA	40.0	44.40	49.10	5	64.5	46.5	2	X
3KP43A	3KP43CA	43.0	47.80	52.80	5	69.4	43.2	2	X
3KP45A	3KP45CA	45.0	50.00	55.30	5	72.7	41.3	2	X
3KP48A	3KP48CA	48.0	53.30	58.90	5	77.4	38.8	2	X
3KP51A	3KP51CA	51.0	56.70	62.70	5	82.4	36.4	2	X
3KP54A	3KP54CA	54.0	60.00	66.30	5	87.1	34.4	2	X
3KP58A	3KP58CA	58.0	64.40	71.20	5	93.6	32.1	2	X
3KP60A	3KP60CA	60.0	66.70	73.70	5	96.8	31.0	2	X
3KP64A	3KP64CA	64.0	71.10	78.60	5	103.0	29.1	2	X
3KP70A	3KP70CA	70.0	77.80	86.00	5	113.0	26.5	2	X
3KP75A	3KP75CA	75.0	83.30	92.10	5	121.0	24.8	2	X
3KP78A	3KP78CA	78.0	86.70	95.80	5	126.0	23.8	2	X
3KP85A	3KP85CA	85.0	94.40	104.00	5	137.0	21.9	2	X
3KP90A	3KP90CA	90.0	100.00	111.00	5	146.0	20.5	2	X
3KP100A	3KP100CA	100.0	111.00	123.00	5	162.0	18.5	2	X
3KP110A	3KP110CA	110.0	122.00	135.00	5	177.0	16.9	2	X
3KP120A	3KP120CA	120.0	133.00	147.00	5	193.0	15.5	2	X
3KP130A	3KP130CA	130.0	144.00	159.00	5	209.0	14.4	2	X
3KP150A	3KP150CA	150.0	167.00	185.00	5	243.0	12.3	2	X
3KP160A	3KP160CA	160.0	178.00	197.00	5	259.0	11.6	2	X
3KP170A	3KP170CA	170.0	189.00	209.00	5	275.0	10.9	2	X
3KP180A	3KP180CA	180.0	200.00	221.00	5	289.0	10.4	2	X
3KP190A	3KP190CA	190.0	211.00	233.00	5	310.0	9.7	2	X
3KP200A	3KP200CA	200.0	222.00	246.00	5	329.2	9.1	2	X
3KP210A	3KP210CA	210.0	233.00	258.00	5	349.5	8.6	2	X
3KP220A	3KP220CA	220.0	244.00	270.00	5	371.1	8.1	2	X

For parts without A , the V_{BR} is $\pm 10\%$ and V_C is 5% higher than with A parts

For bidirectional type having V_R of 10 volts and less, the I_R limit is double.

Ratings and Characteristic Curves ($T_A=25^\circ\text{C}$ unless otherwise noted)

Figure 1 - Peak Pulse Power Rating Curve

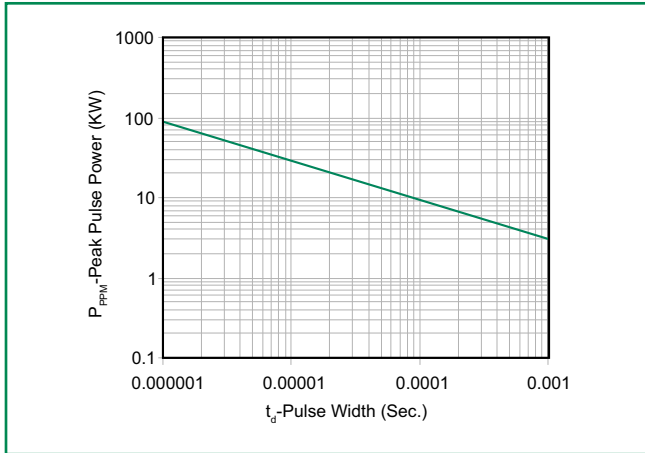

Figure 2 - Pulse Derating Curve

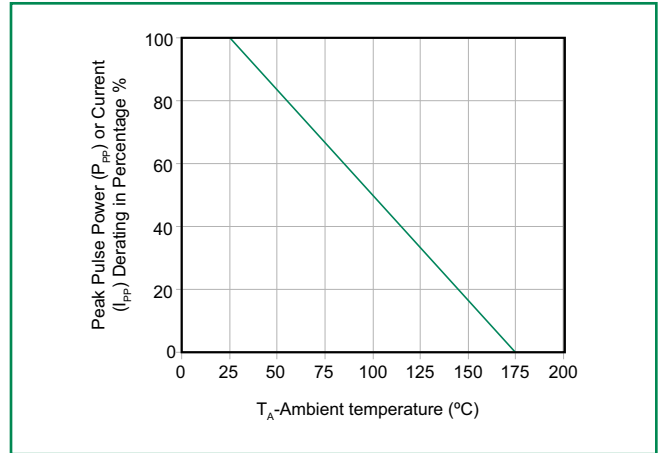

Figure 3 - Pulse Waveform



Figure 4 - Typical Junction Capacitance

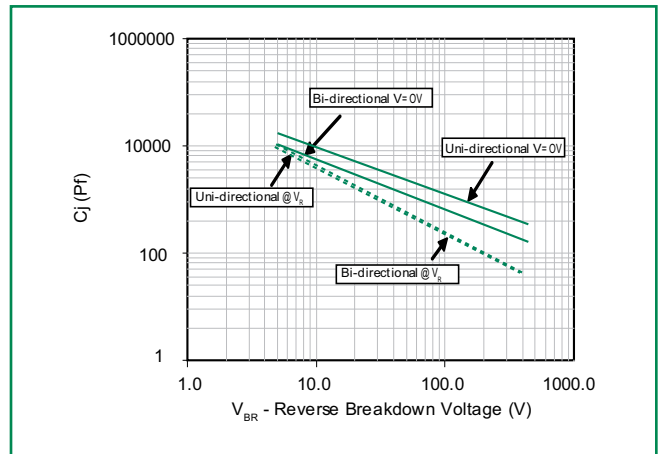

Figure 5 - Steady State Power Derating Curve

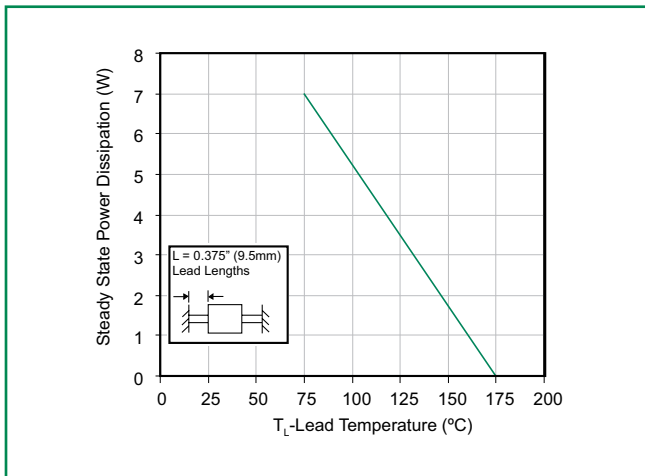
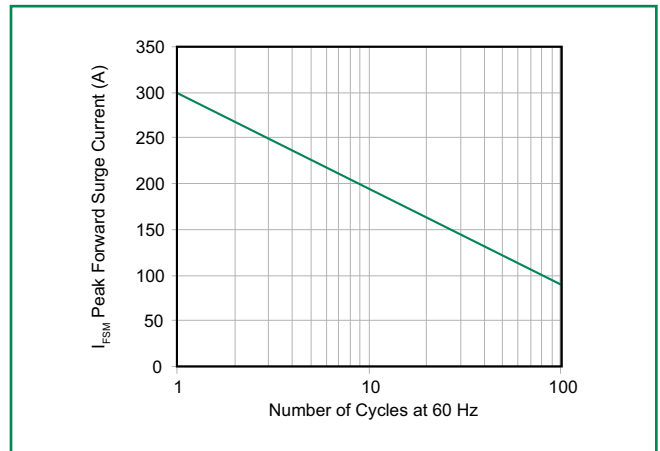

Figure 6 - Maximum Non-Repetitive Peak Forward Surge Current



3KP Series

Soldering Parameters

Reflow Condition		Lead-free assembly
Pre Heat	- Temperature Min ($T_{s(min)}$)	150°C
	- Temperature Max ($T_{s(max)}$)	200°C
	- Time (min to max) (t_s)	60 – 180 secs
Average ramp up rate (Liquidus Temp (T_L) to peak)		3°C/second max
$T_{s(max)}$ to T_L - Ramp-up Rate		3°C/second max
Reflow	- Temperature (T_L) (Liquidus)	217°C
	- Time (min to max) (t_s)	60 – 150 seconds
Peak Temperature (T_p)		260 ^{+0/-5} °C
Time within 5°C of actual peak Temperature (t_p)		20 – 40 seconds
Ramp-down Rate		6°C/second max
Time 25°C to peak Temperature (T_p)		8 minutes Max.
Do not exceed		280°C

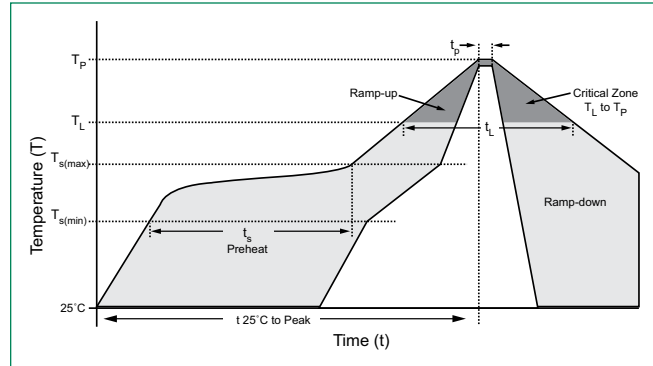

Flow/Wave Soldering (Solder Dipping)

Peak Temperature :	265°C
Dipping Time :	10 seconds
Soldering :	1 time

Physical Specifications

Weight	0.07oz., 2.1g
Case	P600 molded plastic body over passivated junction.
Polarity	Color band denotes the cathode except Bipolar.
Terminal	Matte Tin axial leads, solderable per JESD22-B102D.

Environmental Specifications

Temperature Cycle	JESD22-A104
Pressure Cooker	JESD 22-A102
High Temp. Storage	JESD22-A103
HTRB	JESD22-A108
Thermal Shock	JESD22-A106

Dimensions

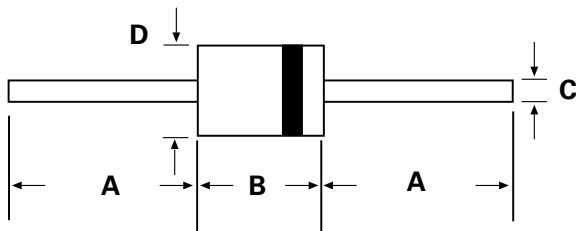

P600

Dimensions	Inches		Millimeters	
	Min	Max	Min	Max
A	1.000	-	25.40	-
B	0.340	0.360	8.60	9.10
C	0.048	0.052	1.22	1.32
D	0.340	0.360	8.60	9.10

Part Numbering System

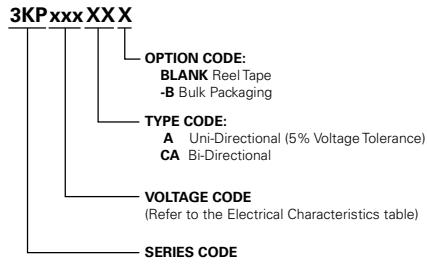

Part Marking System

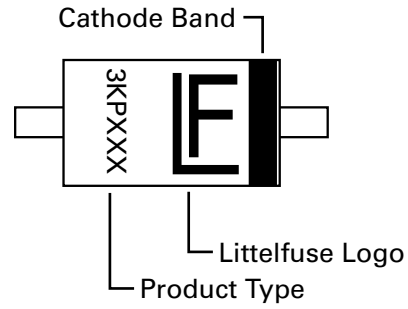

Packaging

Part Number	Component Package	Quantity	Packaging Option	Packaging Specification
3KPxxxXX	P600	800	Tape & Reel	EIA STD RS-296E
3KPxxxXX-B	P600	500	BULK	Littelfuse Concord Packing Spec. DM-0016