



SPN8080

N-Channel Enhancement Mode MOSFET

DESCRIPTION

The SPN8080 is the N-Channel logic enhancement mode power field effect transistors are produced using high cell density , DMOS trench technology.

This high density process is especially tailored to minimize on-state resistance.

These devices are particularly suited for low voltage application , notebook computer power management and other battery powered circuits where high-side switching .

FEATURES

- ◆ 80V/80A, $R_{DS(ON)} = 4.7m\Omega @ V_{GS} = 10V$
- ◆ 80V/37A, $R_{DS(ON)} = 8.7m\Omega @ V_{GS} = 6V$
- ◆ Super high density cell design for extremely low $R_{DS(ON)}$
- ◆ Exceptional on-resistance and maximum DC current capability
- ◆ TO-220-3L package design

APPLICATIONS

- DC/DC Converter
- Load Switch
- SMPS Secondary Side Synchronous Rectifier

PIN CONFIGURATION(TO-220-3L)

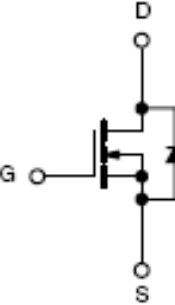
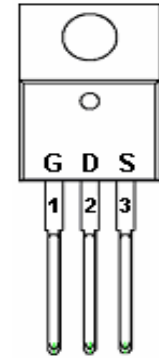

PART MARKING

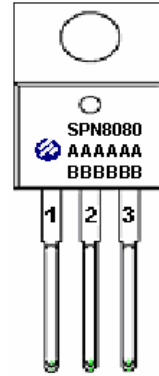

A : Lot Code
 B : Date Code
 (YY / MM / DD)



SPN8080

N-Channel Enhancement Mode MOSFET

PIN DESCRIPTION

Pin	Symbol	Description
1	G	Gate
2	D	Drain
3	S	Source

ORDERING INFORMATION

Part Number	Package	Part Marking
SPN8080T220TGB	TO-220-3L	SPN8080

※ SPN8080T220TGB: Tube ; Pb – Free; Halogen – Free

ABSOLUTE MAXIMUM RATINGS

($T_A=25^{\circ}\text{C}$ Unless otherwise noted)

Parameter	Symbol	Typical	Unit
Drain-Source Voltage	V_{DS}	80	V
Gate –Source Voltage	V_{GS}	± 20	V
Continuous Drain Current($T_J=150^{\circ}\text{C}$)	I_D	$T_A=25^{\circ}\text{C}$ 80	A
		$T_A=70^{\circ}\text{C}$ 15	
Pulsed Drain Current	I_{DM}	300	A
Avalanche Current	I_{AS}	15	A
Power Dissipation	P_D	$T_A=25^{\circ}\text{C}$ 62.5	W
		$T_A=70^{\circ}\text{C}$ 3.38	
Avalanche Energy with Single Pulse ($T_J=25^{\circ}\text{C}$, $I_D=30\text{A}$, $V_{DD}=37.5\text{V}$)	E_{AS}	400	mJ
Operating Junction Temperature	T_J	-55/150	$^{\circ}\text{C}$
Storage Temperature Range	T_{STG}	-55/150	$^{\circ}\text{C}$
Thermal Resistance-Junction to Ambient	$R_{\theta JA}$	2	$^{\circ}\text{C}/\text{W}$



SPN8080

N-Channel Enhancement Mode MOSFET

ELECTRICAL CHARACTERISTICS

(TA=25°C Unless otherwise noted)

Parameter	Symbol	Conditions	Min.	Typ	Max.	Unit
Static						
Drain-Source Breakdown Voltage	$V_{(BR)DSS}$	$V_{GS}=0V, I_D=250\mu A$	80			V
Gate Threshold Voltage	$V_{GS(th)}$	$V_{DS}=V_{GS}, I_D=250\mu A$	2.0		4.0	
Gate Leakage Current	I_{GSS}	$V_{DS}=0V, V_{GS}=\pm 20V$			± 100	nA
Zero Gate Voltage Drain Current	I_{DSS}	$V_{DS}=80V, V_{GS}=0V$			1	uA
		$V_{DS}=80V, V_{GS}=0V$ $T_J = 150^\circ C$			250	
On-State Drain Current	$I_{D(on)}$	$V_{DS} \geq 5V, V_{GS} = 10V$	70			A
Drain-Source On-Resistance	$R_{DS(on)}$	$V_{GS} = 10V, I_D=80A$		4.0	4.7	mΩ
		$V_{GS} = 6V, I_D=37A$		5.8	8.7	
Forward Transconductance	g_{fs}	$V_{DS}=10V, I_D=80A$		150		S
Diode Forward Voltage	V_{SD}	$I_S=40A, V_{GS} = 0V$			1.5	V
Dynamic						
Total Gate Charge	Q_g	$V_{DS}=40V, V_{GS}=10V$ $I_D= 80A$		250		nC
Gate-Source Charge	Q_{gs}			83		
Gate-Drain Charge	Q_{gd}			62		
Input Capacitance	C_{iss}	$V_{DS}=25V, V_{GS}=0V$ $f=1MHz$		14500		pF
Output Capacitance	C_{oss}			850		
Reverse Transfer Capacitance	C_{rss}			280		
Turn-On Time	$t_{d(on)}$	$V_{DD}=40V, R_L=20\Omega$ $I_D=37A, V_{GEN}=10V$ $R_G=3.3\Omega$		80		nS
	t_r			37		
Turn-Off Time	$t_{d(off)}$			140		
	t_f			27		



SPN8080 N-Channel Enhancement Mode MOSFET

TYPICAL CHARACTERISTICS

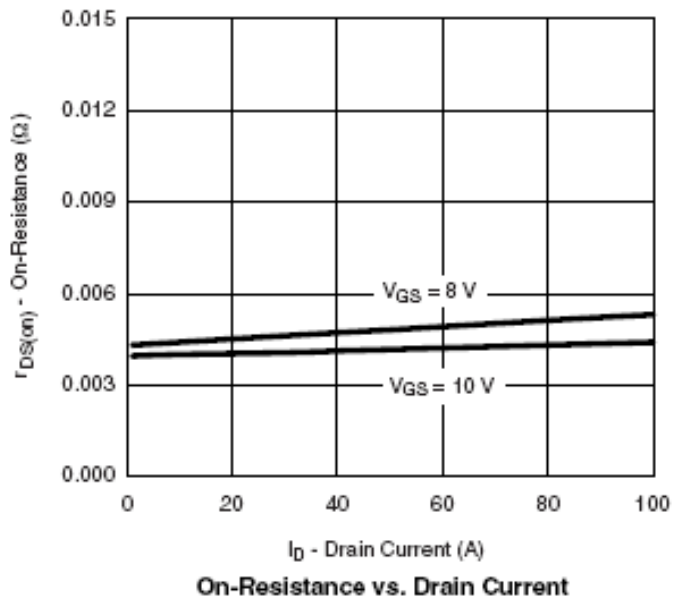
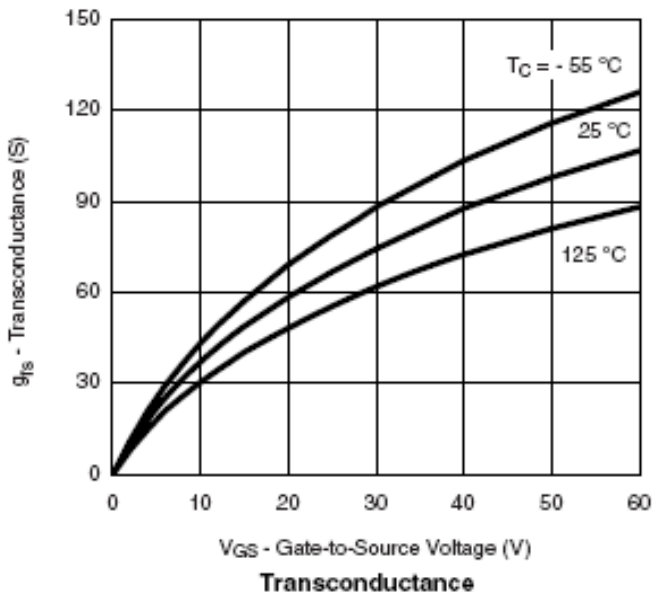
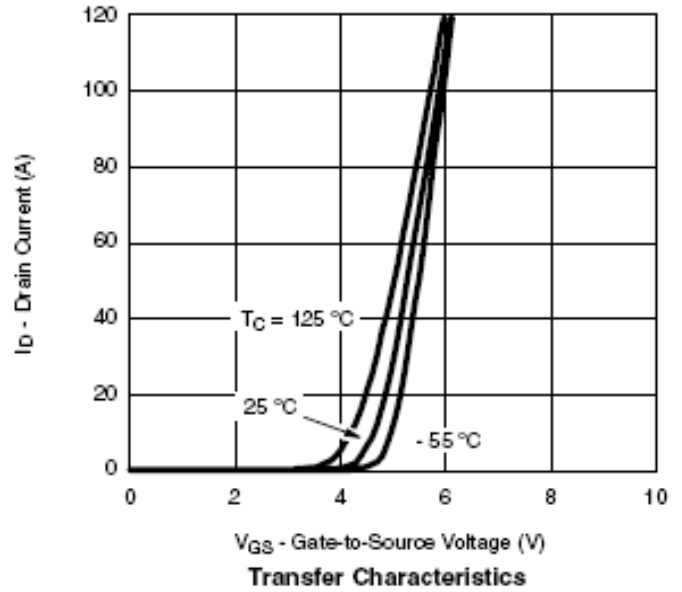
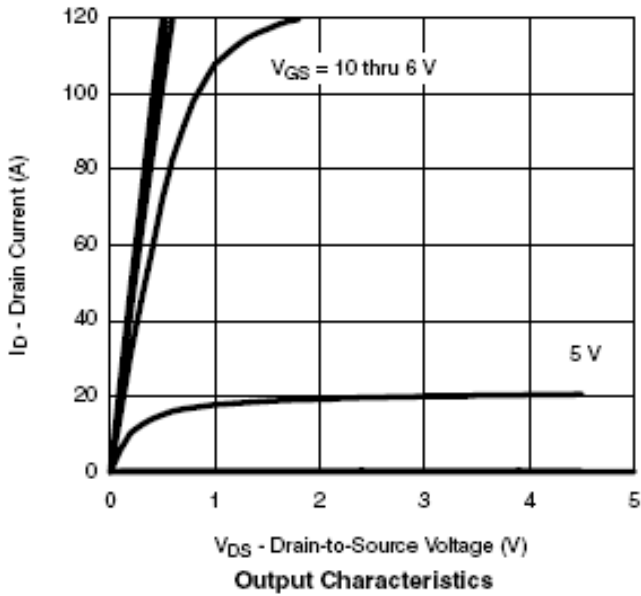



SPN8080 N-Channel Enhancement Mode MOSFET

TYPICAL CHARACTERISTICS

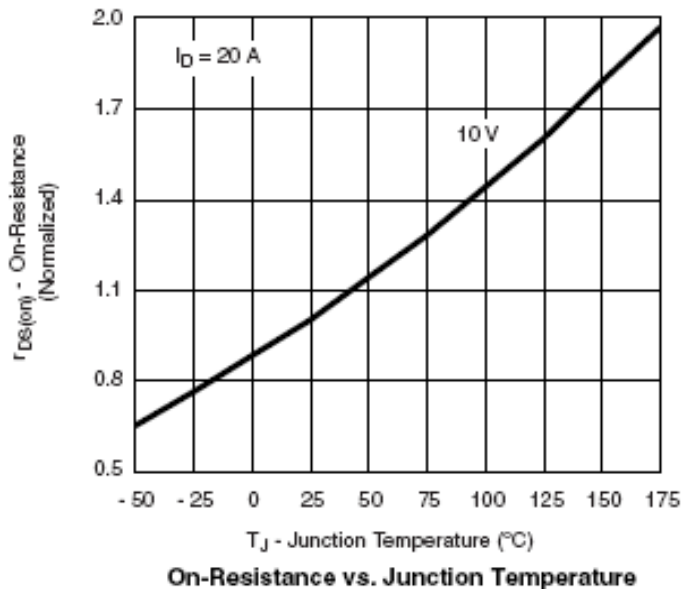
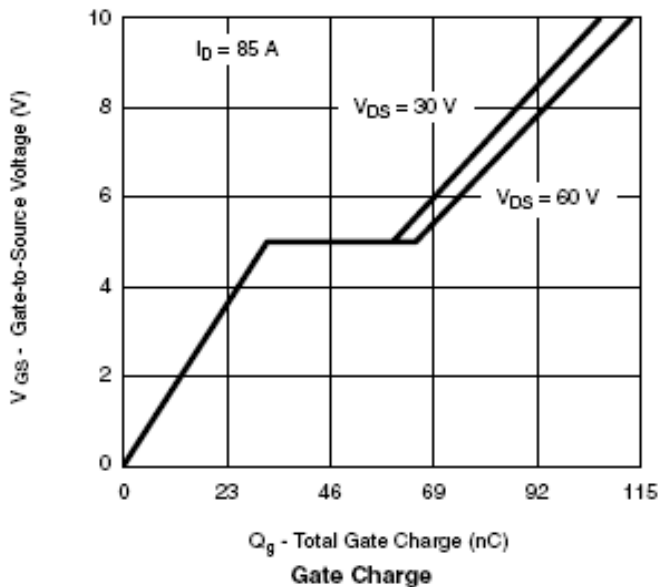
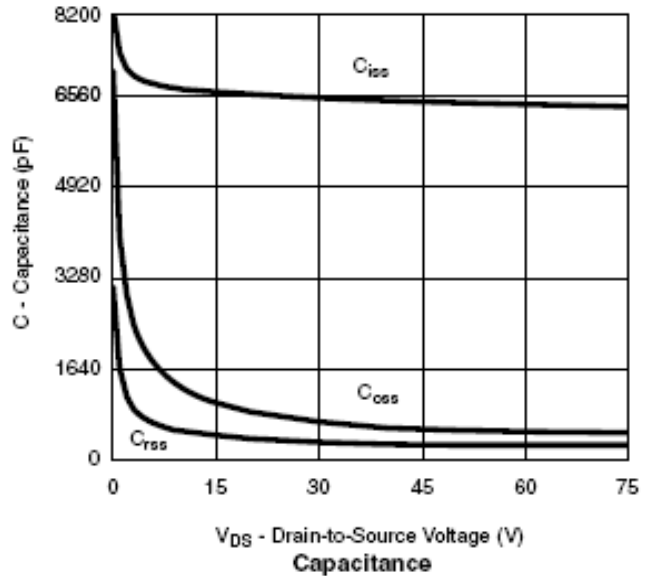
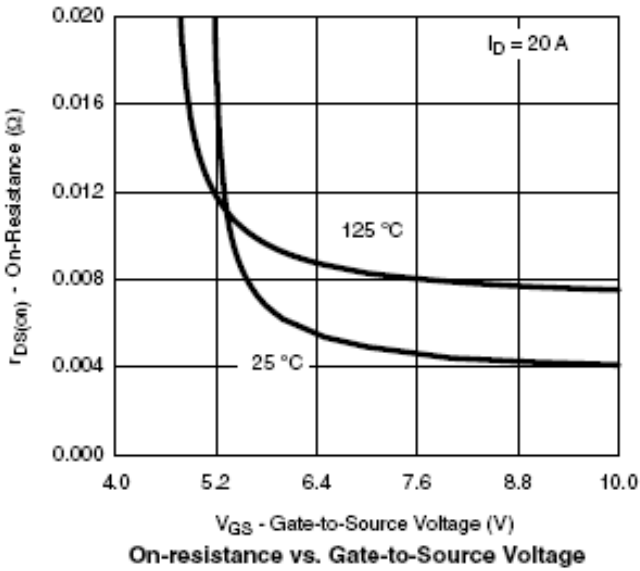



SPN8080 N-Channel Enhancement Mode MOSFET

TYPICAL CHARACTERISTICS

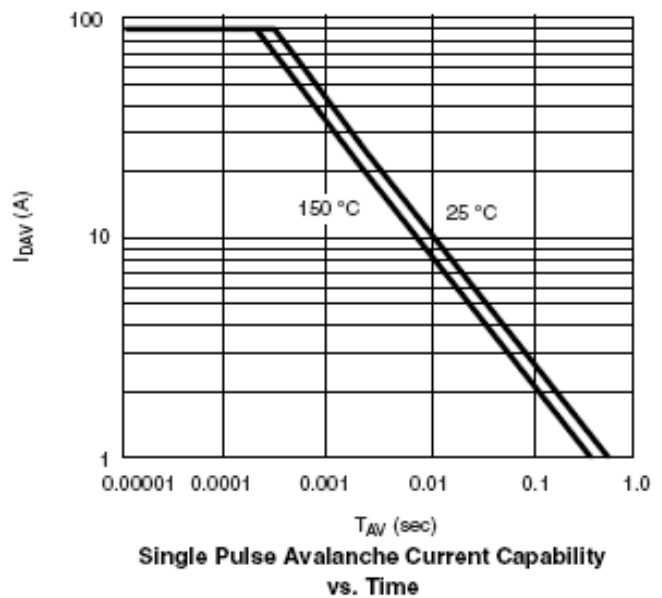
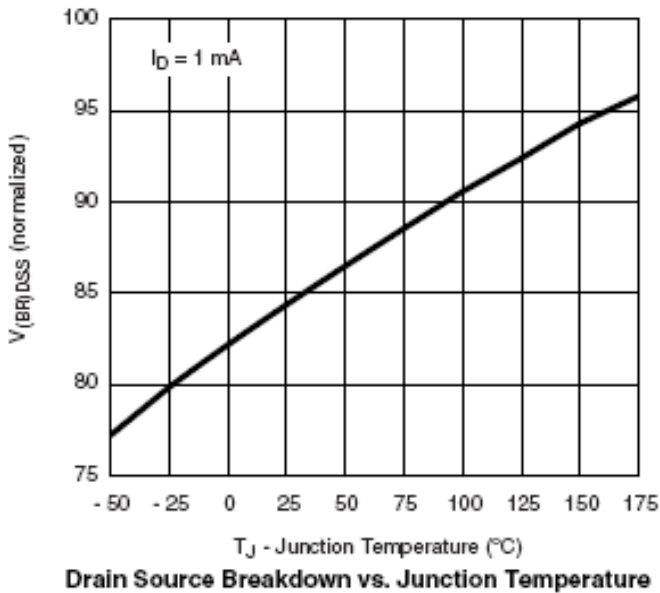
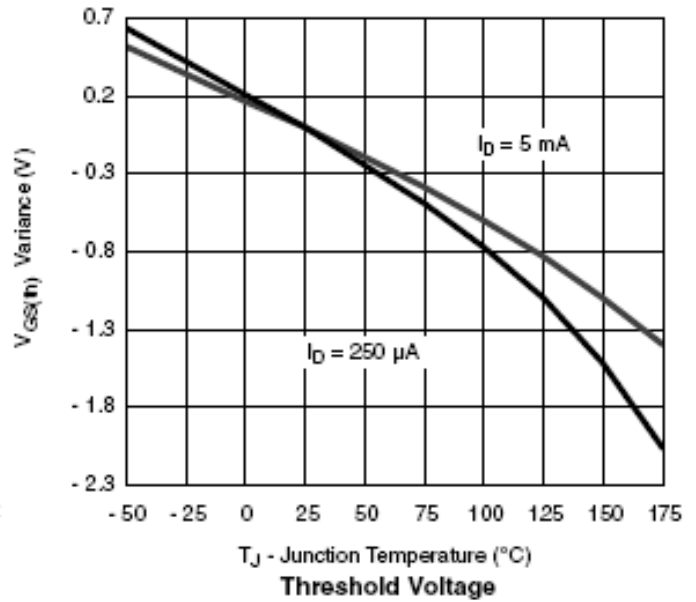
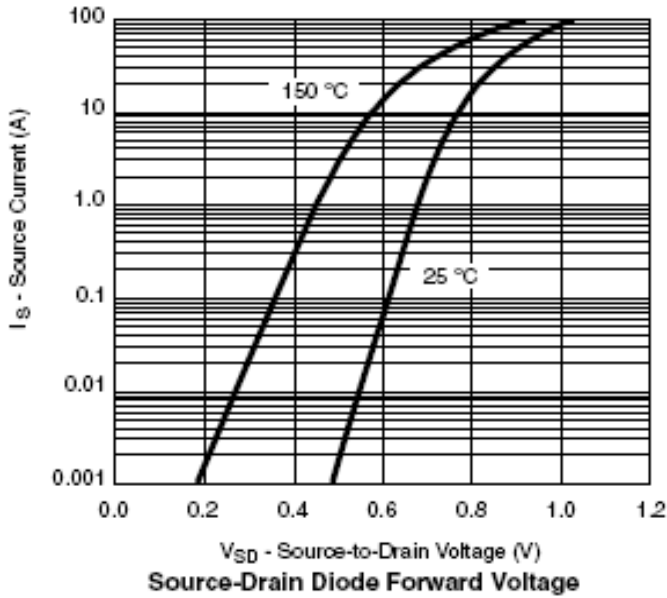



SPN8080 N-Channel Enhancement Mode MOSFET

TYPICAL CHARACTERISTICS

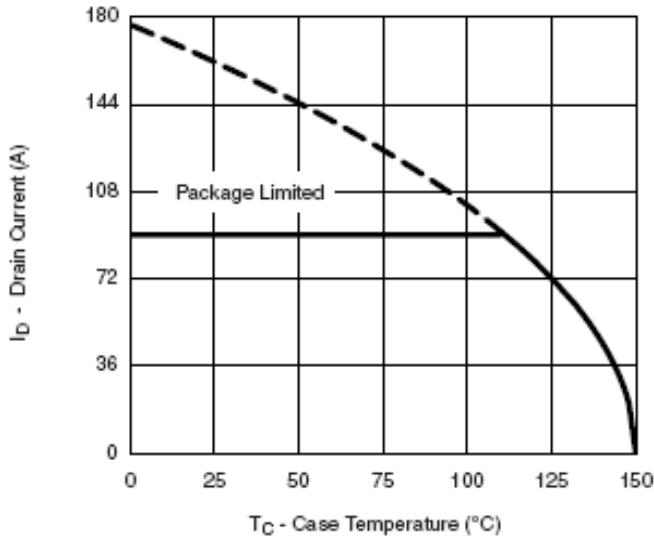

Maximum Drain Current vs. Case Temperature

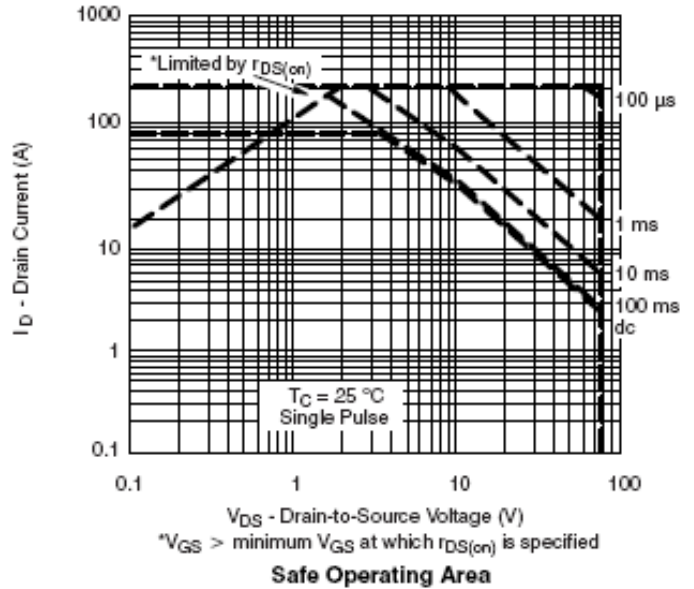

Safe Operating Area

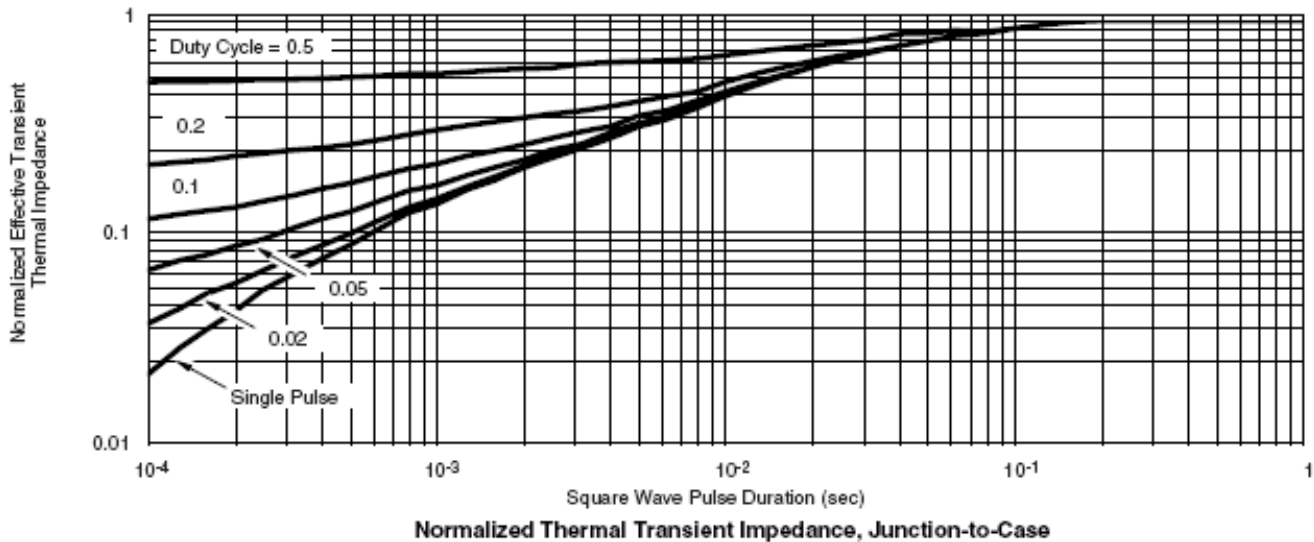

Normalized Thermal Transient Impedance, Junction-to-Case



SPN8080

N-Channel Enhancement Mode MOSFET

TO-220-3L PACKAGE OUTLINE

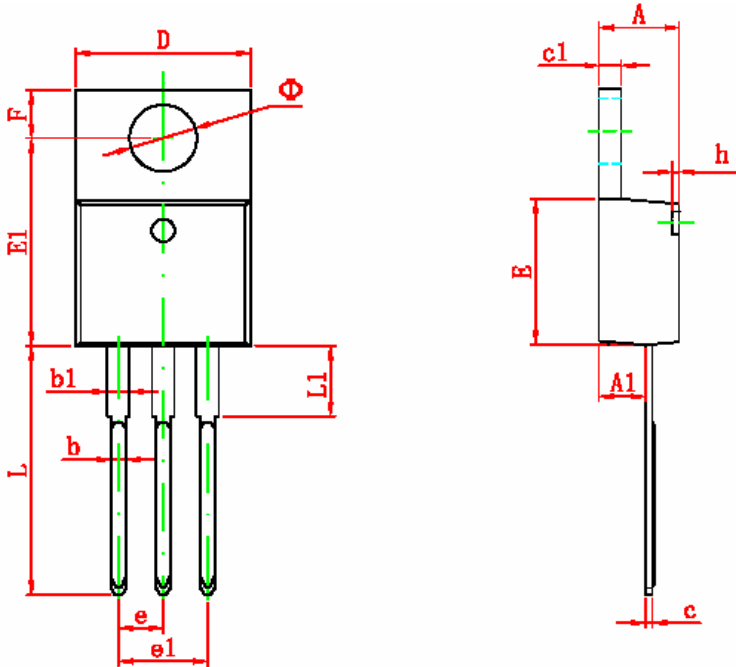

Symbol	Dimensions In Millimeters		Dimensions In Inches	
	Min	Max	Min	Max
A	4.470	4.670	0.176	0.184
A1	2.520	2.820	0.099	0.111
b	0.710	0.910	0.028	0.036
b1	1.170	1.370	0.046	0.054
c	0.310	0.530	0.012	0.021
c1	1.170	1.370	0.046	0.054
D	10.010	10.310	0.394	0.406
E	8.500	8.900	0.335	0.350
E1	12.060	12.460	0.475	0.491
e	2.540 TYP		0.100 TYP	
e1	4.980	5.180	0.196	0.204
F	2.590	2.890	0.102	0.114
h	0.000	0.300	0.000	0.012
L	13.400	13.800	0.528	0.543
L1	3.560	3.960	0.140	0.156
• •	3.735	3.935	0.147	0.155



SPN8080

N-Channel Enhancement Mode MOSFET

Information provided is alleged to be exact and consistent. SYNC Power Corporation presumes no responsibility for the penalties of use of such information or for any violation of patents or other rights of third parties which may result from its use. No license is granted by allegation or otherwise under any patent or patent rights of SYNC Power Corporation. Conditions mentioned in this publication are subject to change without notice. This publication surpasses and replaces all information previously supplied. SYNC Power Corporation products are not authorized for use as critical components in life support devices or systems without express written approval of SYNC Power Corporation.

©The SYNC Power logo is a registered trademark of SYNC Power Corporation

©2004 SYNC Power Corporation – Printed in Taiwan – All Rights Reserved

SYNC Power Corporation

9F-5, No.3-2, Park Street

NanKang District (NKSP), Taipei, Taiwan 115

Phone: 886-2-2655-8178

Fax: 886-2-2655-8468



SPN8080

N-Channel Enhancement Mode MOSFET

©<http://www.syncpower.com>