

TPC8021-H

High-Efficiency DC/DC Converter Applications
 Notebook PC Applications
 Portable-Equipment Applications

- Small footprint due to a small and thin package
- High-speed switching
- Small gate charge: $Q_{SW} = 3.6 \text{ nC (typ.)}$
- Low drain-source ON-resistance: $R_{DS(ON)} = 13.5 \text{ m}\Omega \text{ (typ.)}$
- High forward transfer admittance: $|Y_{fs}| = 19 \text{ S (typ.)}$
- Low leakage current: $I_{DSS} = 10 \text{ }\mu\text{A (max) (} V_{DS} = 30 \text{ V)}$
- Enhancement mode: $V_{th} = 1.1 \text{ to } 2.3 \text{ V (} V_{DS} = 10 \text{ V, } I_D = 1 \text{ mA)}$

Absolute Maximum Ratings (Ta = 25°C)

Characteristic		Symbol	Rating	Unit
Drain-source voltage		V_{DSS}	30	V
Drain-gate voltage ($R_{GS} = 20 \text{ k}\Omega$)		V_{DGR}	30	V
Gate-source voltage		V_{GSS}	± 20	V
Drain current	DC (Note 1)	I_D	11	A
	Pulsed (Note 1)	I_{DP}	44	
Drain power dissipation	(t = 10 s) (Note 2a)	P_D	1.9	W
Drain power dissipation	(t = 10 s) (Note 2b)	P_D	1.0	W
Single-pulse avalanche energy	(Note 3)	E_{AS}	79	mJ
Avalanche current		I_{AR}	11	A
Repetitive avalanche energy (Note 2a) (Note 4)		E_{AR}	0.14	mJ
Channel temperature		T_{ch}	150	°C
Storage temperature range		T_{stg}	-55 to 150	°C

Note: Note 1, Note 2, Note 3 and Note 4: See the next page.

Using continuously under heavy loads (e.g. the application of high temperature/current/voltage and the significant change in temperature, etc.) may cause this product to decrease in the reliability significantly even if the operating conditions (i.e. operating temperature/current/voltage, etc.) are within the absolute maximum ratings. Please design the appropriate reliability upon reviewing the Toshiba Semiconductor Reliability Handbook ("Handling Precautions"/Derating Concept and Methods) and individual reliability data (i.e. reliability test report and estimated failure rate, etc).

This transistor is an electrostatic-sensitive device. Handle with care.

Unit: mm

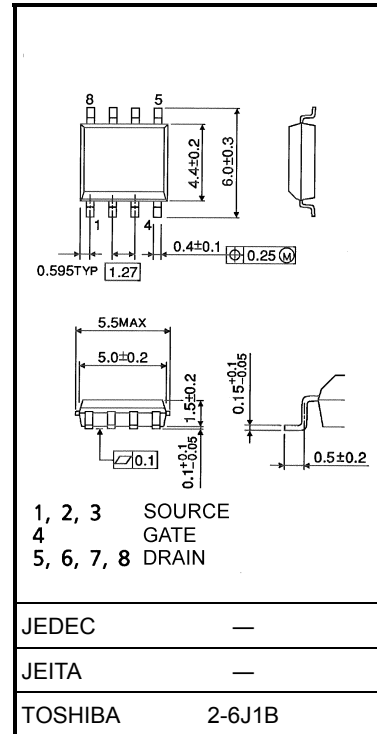

Weight: 0.085 g (typ.)

Circuit Configuration

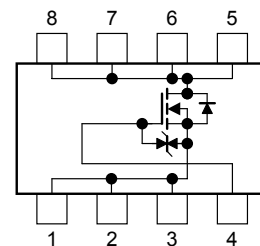

Thermal Characteristics

Characteristic	Symbol	Max	Unit
Thermal resistance, channel to ambient (t = 10 s) (Note 2a)	$R_{th(ch-a)}$	65.8	°C/W
Thermal resistance, channel to ambient (t = 10 s) (Note 2b)	$R_{th(ch-a)}$	125	°C/W

Marking (Note 5)

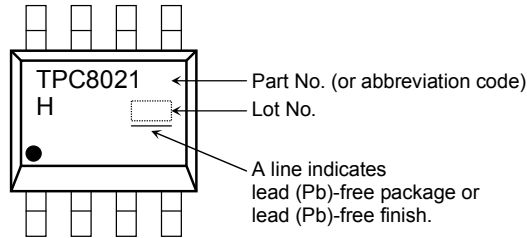

Note 1: The channel temperature should not exceed 150°C during use.

Note 2: (a) Device mounted on a glass-epoxy board (a)

(b) Device mounted on a glass-epoxy board (b)

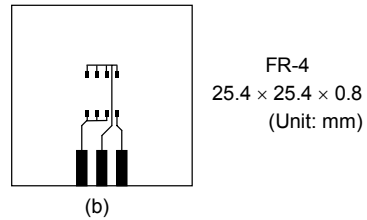
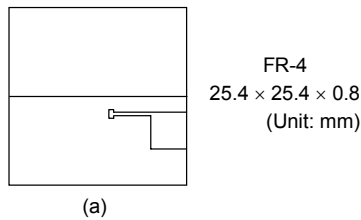

Note 3: $V_{DD} = 24\text{ V}$, $T_{ch} = 25^\circ\text{C}$ (initial), $L = 0.5\text{ mH}$, $R_G = 25\ \Omega$, $I_{AR} = 11\text{ A}$

Note 4: Repetitive rating: pulse width limited by max channel temperature

Note 5: • on the lower left of the marking indicates Pin 1.

* Weekly code: (Three digits)

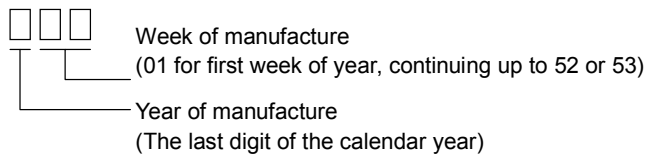

Electrical Characteristics (Ta = 25°C)

Characteristic		Symbol	Test Condition	Min	Typ.	Max	Unit
Gate leakage current		I_{GSS}	$V_{GS} = \pm 16\text{ V}, V_{DS} = 0\text{ V}$	—	—	± 10	μA
Drain cutoff current		I_{DSS}	$V_{DS} = 30\text{ V}, V_{GS} = 0\text{ V}$	—	—	10	μA
Drain-source breakdown voltage		$V_{(BR)DSS}$	$I_D = 10\text{ mA}, V_{GS} = 0\text{ V}$	30	—	—	V
		$V_{(BR)DSX}$	$I_D = 10\text{ mA}, V_{GS} = -20\text{ V}$	15	—	—	
Gate threshold voltage		V_{th}	$V_{DS} = 10\text{ V}, I_D = 1\text{ mA}$	1.1	—	2.3	V
Drain-source ON-resistance		$R_{DS(ON)}$	$V_{GS} = 4.5\text{ V}, I_D = 5.5\text{ A}$	—	18.5	25	$\text{m}\Omega$
			$V_{GS} = 10\text{ V}, I_D = 5.5\text{ A}$	—	13.5	17	
Forward transfer admittance		$ Y_{fs} $	$V_{DS} = 10\text{ V}, I_D = 5.5\text{ A}$	10	19	—	S
Input capacitance		C_{iss}	$V_{DS} = 10\text{ V}, V_{GS} = 0\text{ V}, f = 1\text{ MHz}$	—	640	—	pF
Reverse transfer capacitance		C_{rss}		—	75	—	
Output capacitance		C_{oss}		—	300	—	
Switching time	Rise time	t_r	<p> $V_{GS} = 10\text{ V}$ 0 V $I_D = 5.5\text{ A}$ V_{OUT} 4.7Ω $R_L = 2.7\Omega$ $V_{DD} \approx 15\text{ V}$ Duty $\leq 1\%$, $t_w = 10\text{ }\mu\text{s}$ </p>	—	4	—	ns
	Turn-on time	t_{on}		—	8	—	
	Fall time	t_f		—	4	—	
	Turn-off time	t_{off}		—	18	—	
Total gate charge (gate-source plus gate-drain)		Q_g	$V_{DD} \approx 24\text{ V}, V_{GS} = 10\text{ V}, I_D = 11\text{ A}$	—	11	—	nC
			$V_{DD} \approx 24\text{ V}, V_{GS} = 5\text{ V}, I_D = 11\text{ A}$	—	6.3	—	
Gate-source charge 1		Q_{gs1}	$V_{DD} \approx 24\text{ V}, V_{GS} = 10\text{ V}, I_D = 11\text{ A}$	—	2.2	—	
Gate-drain ("Miller") charge		Q_{gd}	$V_{DD} \approx 24\text{ V}, V_{GS} = 10\text{ V}, I_D = 11\text{ A}$	—	2.6	—	
Gate switch charge		Q_{sw}	$V_{DD} \approx 24\text{ V}, V_{GS} = 10\text{ V}, I_D = 11\text{ A}$	—	3.6	—	

Source-Drain Ratings and Characteristics (Ta = 25°C)

Characteristic		Symbol	Test Condition	Min	Typ.	Max	Unit
Drain reverse current	Pulse (Note 1)	I_{DRP}	—	—	—	44	A
Forward voltage (diode)		V_{DSF}	$I_{DR} = 15\text{ A}, V_{GS} = 0\text{ V}$	—	—	-1.2	V

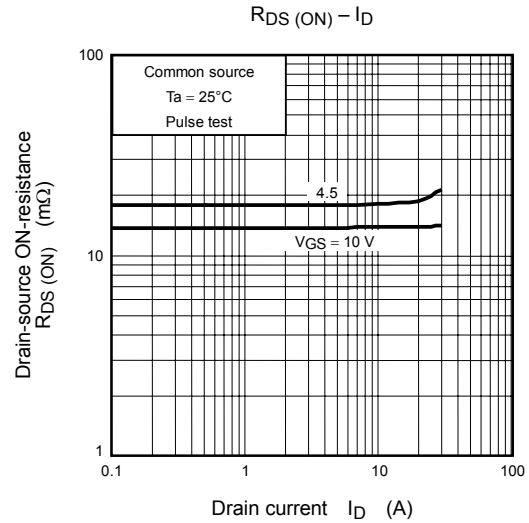
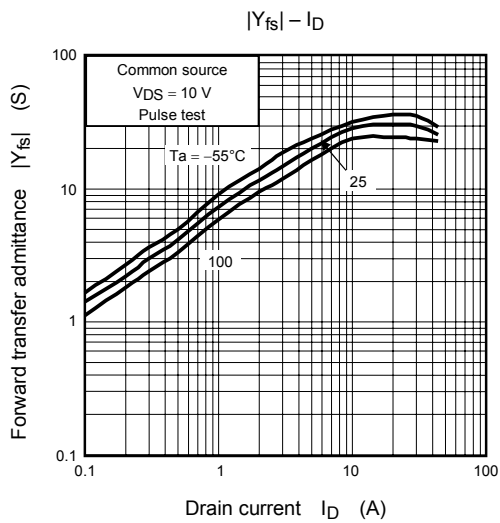
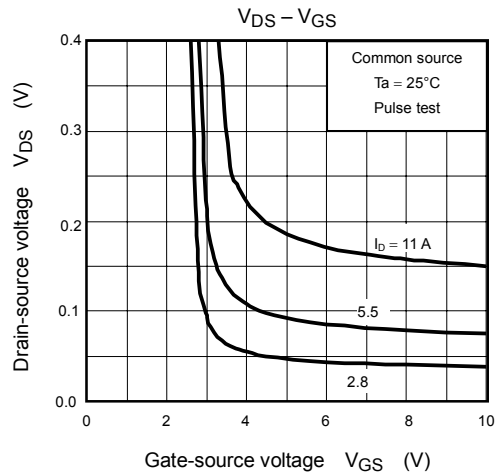
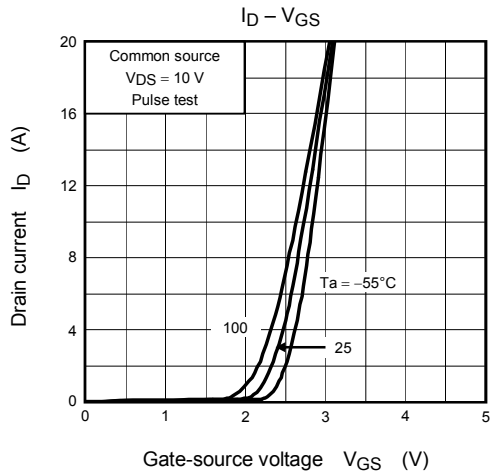
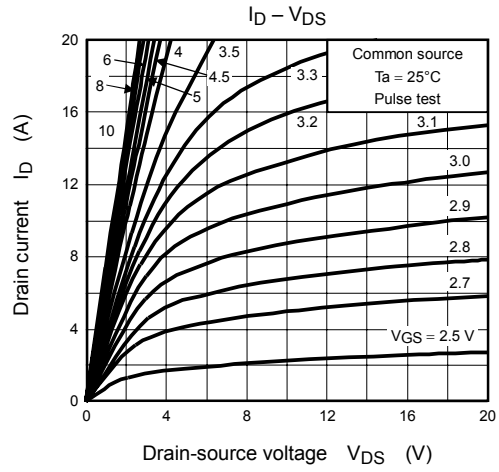
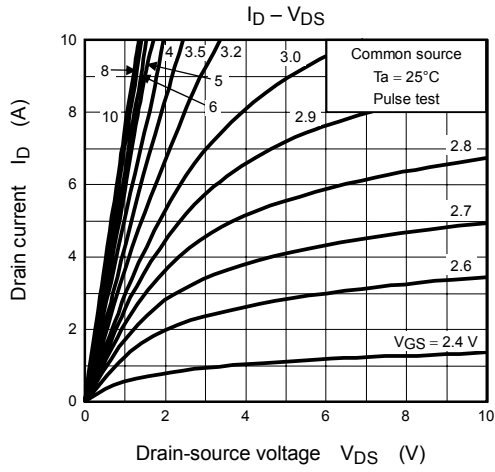

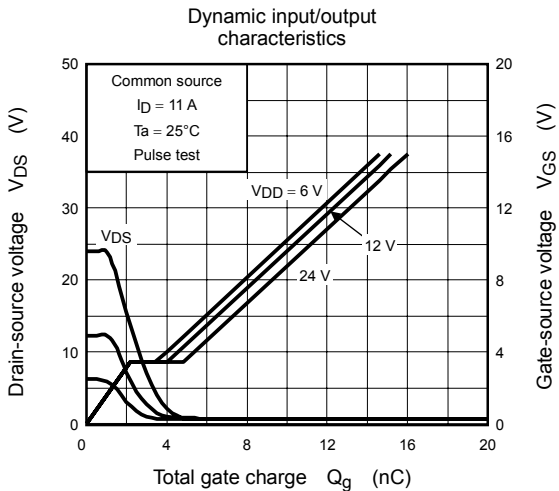
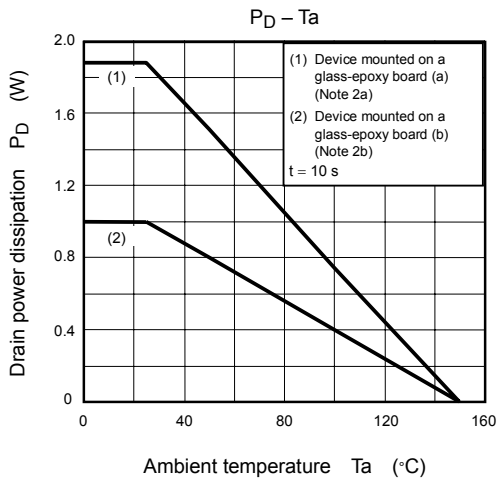
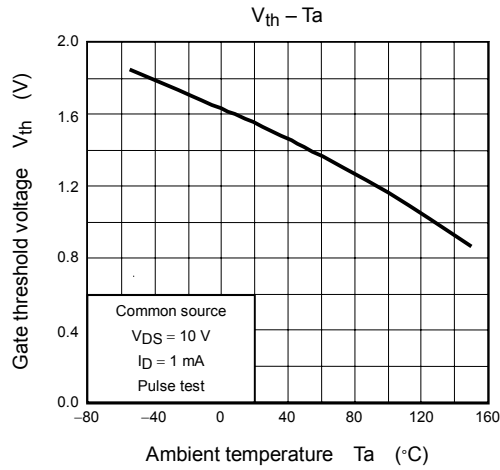
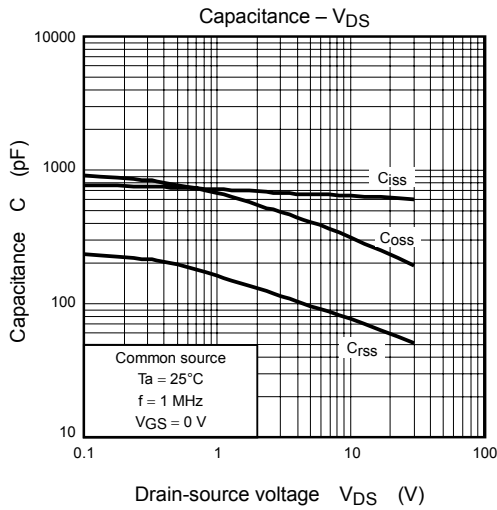
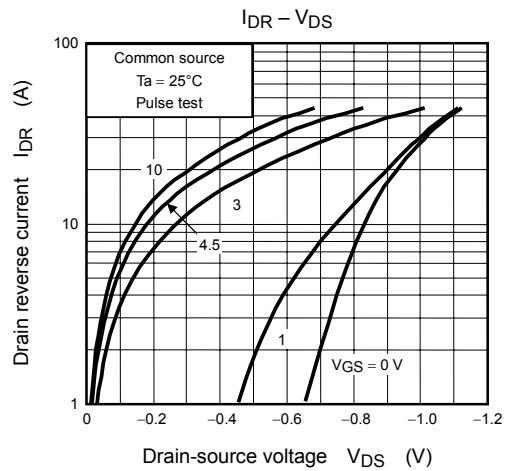
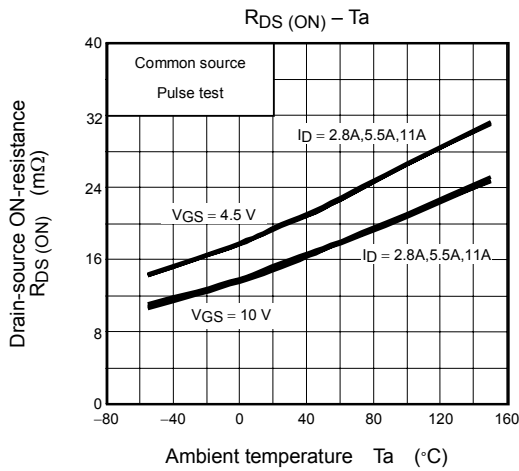

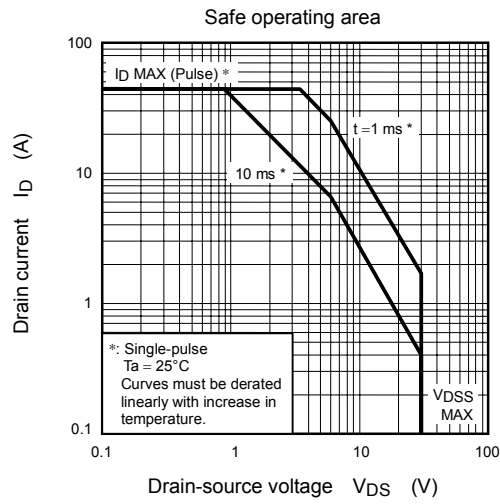
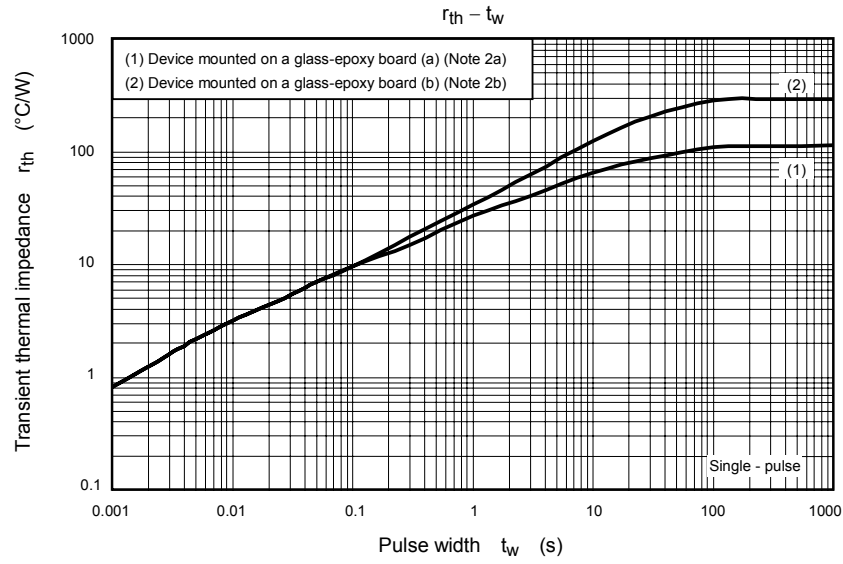

RESTRICTIONS ON PRODUCT USE

060116EAA

- The information contained herein is subject to change without notice. 021023_D
- TOSHIBA is continually working to improve the quality and reliability of its products. Nevertheless, semiconductor devices in general can malfunction or fail due to their inherent electrical sensitivity and vulnerability to physical stress. It is the responsibility of the buyer, when utilizing TOSHIBA products, to comply with the standards of safety in making a safe design for the entire system, and to avoid situations in which a malfunction or failure of such TOSHIBA products could cause loss of human life, bodily injury or damage to property.
In developing your designs, please ensure that TOSHIBA products are used within specified operating ranges as set forth in the most recent TOSHIBA products specifications. Also, please keep in mind the precautions and conditions set forth in the "Handling Guide for Semiconductor Devices," or "TOSHIBA Semiconductor Reliability Handbook" etc. 021023_A
- The TOSHIBA products listed in this document are intended for usage in general electronics applications (computer, personal equipment, office equipment, measuring equipment, industrial robotics, domestic appliances, etc.). These TOSHIBA products are neither intended nor warranted for usage in equipment that requires extraordinarily high quality and/or reliability or a malfunction or failure of which may cause loss of human life or bodily injury ("Unintended Usage"). Unintended Usage include atomic energy control instruments, airplane or spaceship instruments, transportation instruments, traffic signal instruments, combustion control instruments, medical instruments, all types of safety devices, etc. Unintended Usage of TOSHIBA products listed in this document shall be made at the customer's own risk. 021023_B
- The products described in this document shall not be used or embedded to any downstream products of which manufacture, use and/or sale are prohibited under any applicable laws and regulations. 060106_Q
- The information contained herein is presented only as a guide for the applications of our products. No responsibility is assumed by TOSHIBA for any infringements of patents or other rights of the third parties which may result from its use. No license is granted by implication or otherwise under any patent or patent rights of TOSHIBA or others. 021023_C