

Silicon NPN Power Transistors

2SD1445 2SD1445A

DESCRIPTION

- With TO-220Fa package
- Complement to type 2SB948/948A
- High speed switching
- Low collector saturation voltage

APPLICATIONS

- For power amplification, power switching and low-voltage switching applications

PINNING

PIN	DESCRIPTION
1	Base
2	Collector
3	Emitter

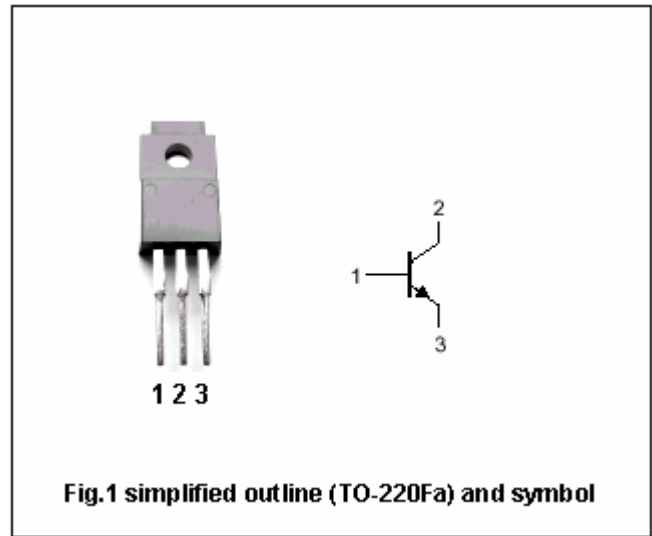
Absolute maximum ratings($T_a=25^\circ\text{C}$)

SYMBOL	PARAMETER	CONDITIONS	VALUE	UNIT
V_{CBO}	Collector-base voltage	2SD1445	40	V
		2SD1445A	50	
V_{CEO}	Collector-emitter voltage	2SD1445	20	V
		2SD1445A	40	
V_{EBO}	Emitter-base voltage	Open collector	5	V
I_C	Collector current		10	A
I_{CM}	Collector current-peak		20	A
P_C	Collector power dissipation	$T_a=25^\circ\text{C}$	2	W
		$T_C=25^\circ\text{C}$	40	
T_j	Junction temperature		150	$^\circ\text{C}$
T_{stg}	Storage temperature		-55~150	$^\circ\text{C}$

Silicon NPN Power Transistors

2SD1445 2SD1445A

CHARACTERISTICS

T_j=25 °C unless otherwise specified

SYMBOL	PARAMETER	CONDITIONS	MIN	TYP.	MAX	UNIT	
V _{(BR)CEO}	Collector-emitter breakdown voltage	2SD1445	I _C =10mA I _B =0	20			V
		2SD1445A		40			
V _{CEsat}	Collector-emitter saturation voltage	I _C =10A ; I _B =0.33A			0.6	V	
V _{BEsat}	Base-emitter saturation voltage	I _C =10A; I _B =0.33A			1.5	V	
I _{CBO}	Collector cut-off current	2SD1445			50	μA	
		2SD1445A					V _{CB} =50V; I _E =0
I _{EBO}	Emitter cut-off current	V _{EB} =5V; I _C =0			50	μA	
h _{FE-1}	DC current gain	I _C =0.1A ; V _{CE} =2V	45				
h _{FE-2}	DC current gain	I _C =3A ; V _{CE} =2V	90		260		
f _T	Transition frequency	I _C =0.5A; V _{CE} =10V, f=10MHz		120		MHz	
C _{OB}	Collector output capacitance	I _E =0; f=1MHz ; V _{CB} =10V		200		pF	

Switching times

t _{on}	Trun-on time	I _C =3A I _{B1} =0.1A, I _{B2} =-0.1A V _{CC} =20V		0.3		μs
t _{stg}	Storage time			0.4		μs
t _f	Fall time			0.1		μs

◆ h_{FE-2} Classifications

Q	P
90-180	130-260

Silicon NPN Power Transistors

2SD1445 2SD1445A

PACKAGE OUTLINE

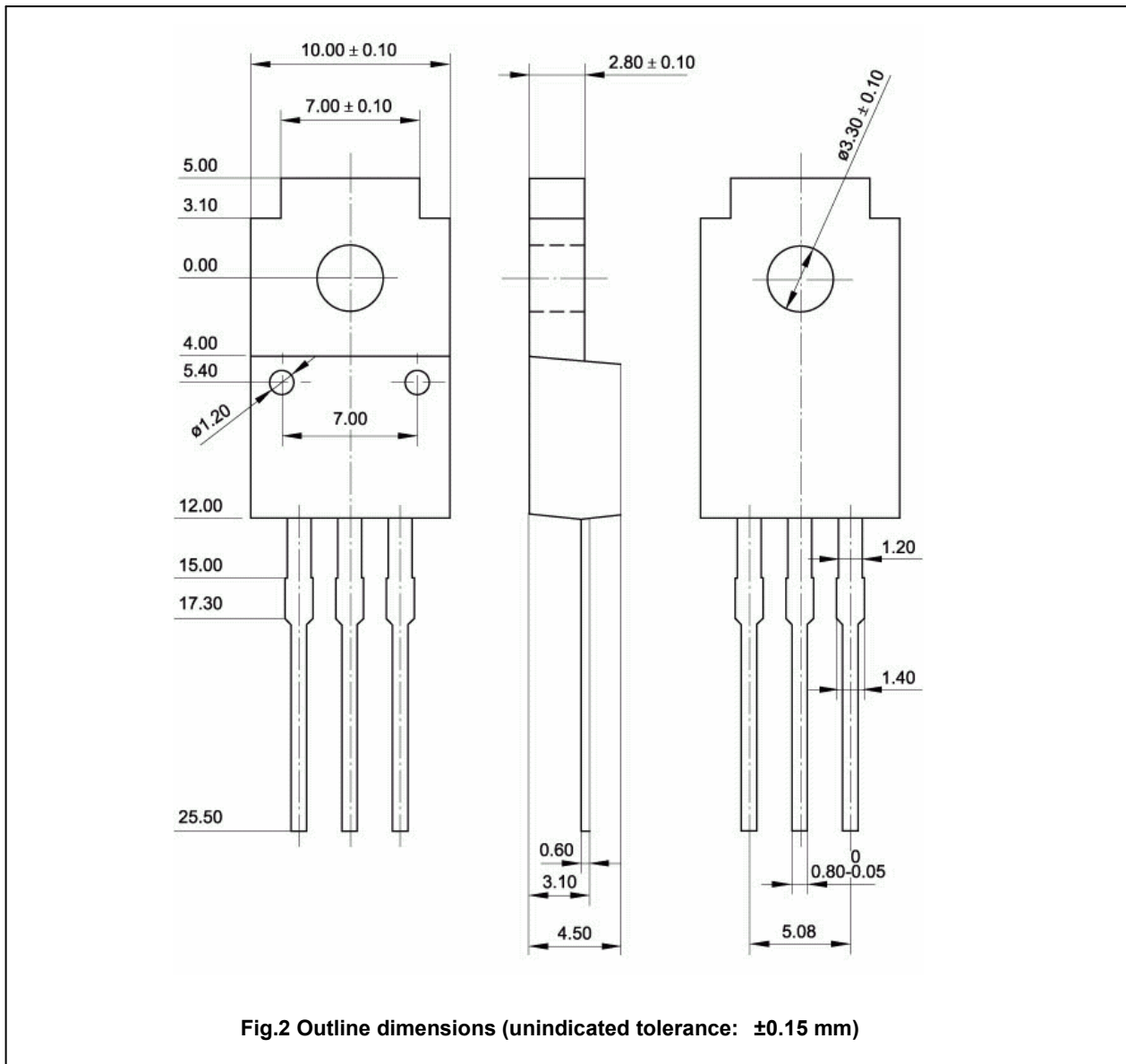

Silicon NPN Power Transistors

2SD1445 2SD1445A

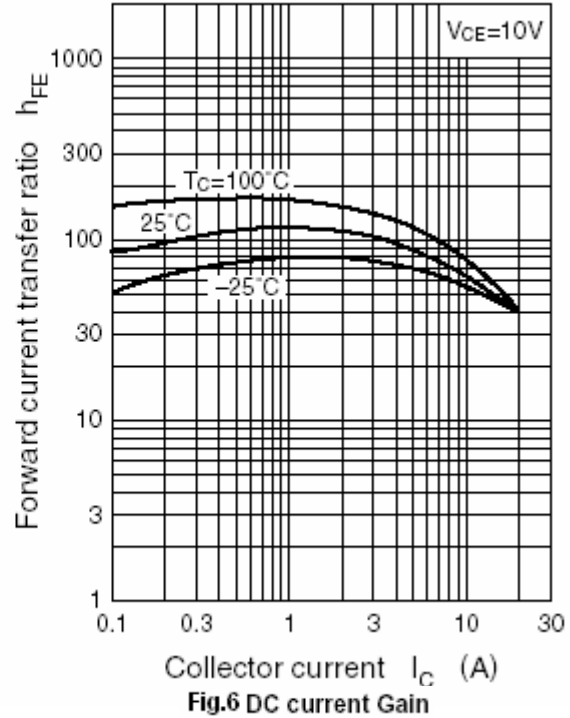
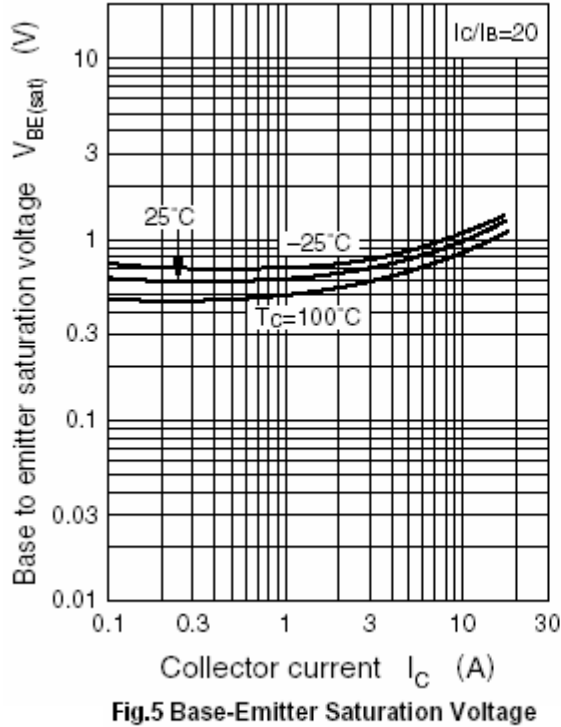
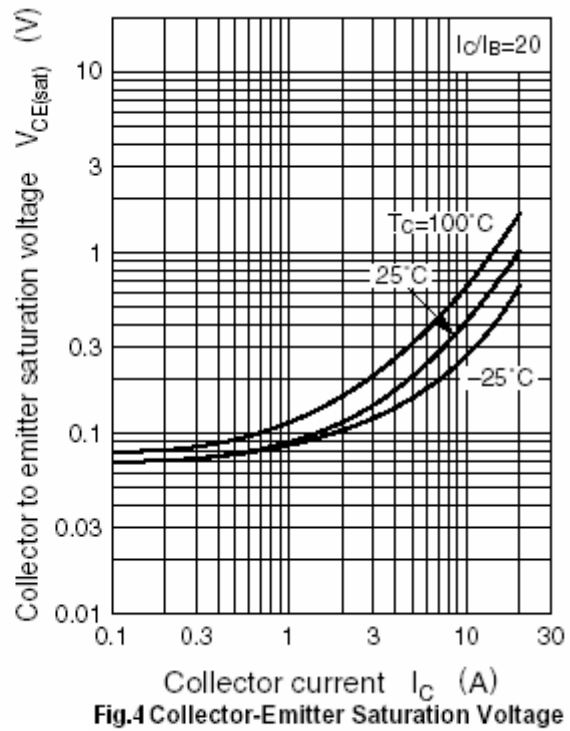
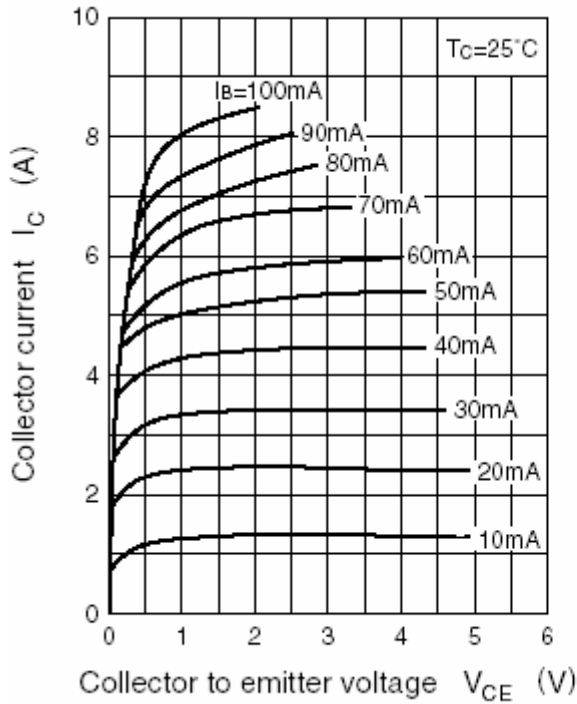

Silicon NPN Power Transistors

2SD1445 2SD1445A

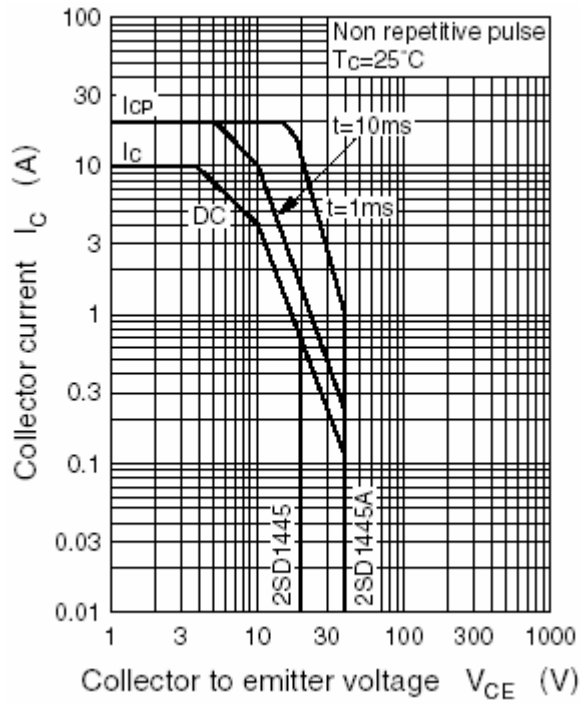

Fig.7 Safe Operating Area

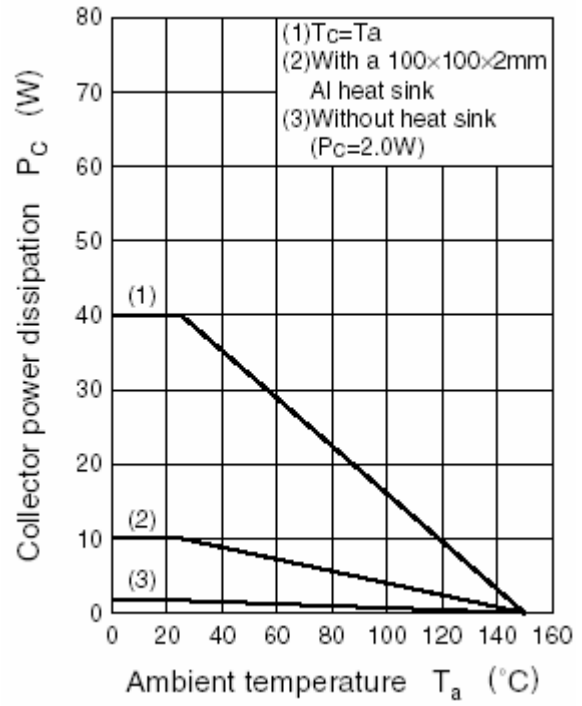

Fig.8 Power Derating