

Features

- ◆ May Be Directly Driven By TTL Signals
- ◆ RoHS Compliant
- ◆ Low Series Resistance
- ◆ Fast Switching Speed
- ◆ No Reverse Bias Required

Description

Gallium Arsenide PIN diodes offer improved performance characteristics over silicon in many microwave semiconductor applications. These benefits result from the intrinsic semiconductor properties of GaAs. Its inherent high carrier mobility results in a low resistance fast switching device. The low carrier concentration in the I region layer produces a near zero punch through bias voltage. Gallium Arsenide's high band gap also assures it will operate at high operating temperatures.

Switching speeds in the low nanosecond range using an inexpensive TTL buffer logic is attainable with GaAs PIN diodes. This performance can be achieved because GaAs PIN diodes exhibit high impedance at a positive bias (up to .5V). Reverse bias is not required for many GaAs PIN diode applications. Low loss, in switch and phase shifter circuits at frequencies up to 40 GHz is possible as a result of low parasitic series resistance in the conducting and non-conducting states.

M/A-COM's GaAs PIN diode chips are also available in several different package styles. See page 4

Absolute Maximum Ratings¹

Parameter	Maximum Value
Operating Temperature	-65°C to +175°C
Storage Temperature	-65°C to +175°C
Power Dissipation	0.25W @ 25°C
Junction Temperature	+175°C
Mounting Temperature	+320°C for 10 seconds

1. Exceeding these limits may cause permanent damage.

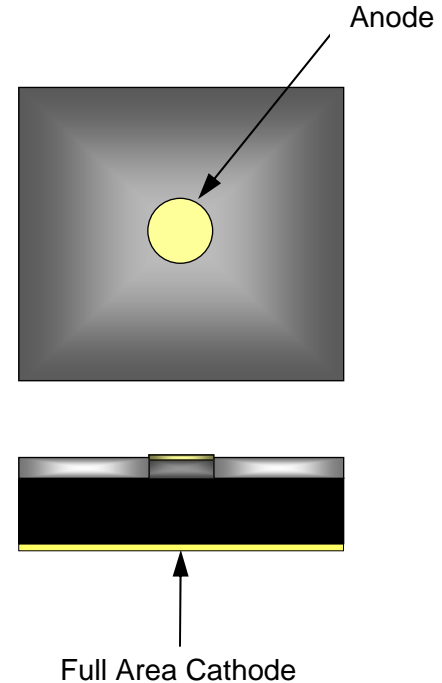

MIL-STD 750 Environmental Ratings

Parameter	Method	Level
Temp. Cycling	1051	5cycles -65°C to +150°C
Vibration	2056	15g's
Constant Acceleration	2006	20,000g's
Moisture Resistance (Packaged diodes)	1021	10 Days

ADVANCED: Data Sheets contain information regarding a product M/A-COM Technology Solutions is considering for development. Performance is based on target specifications, simulated results, and/or prototype measurements. Commitment to develop is not guaranteed.
PRELIMINARY: Data Sheets contain information regarding a product M/A-COM Technology Solutions has under development. Performance is based on engineering tests. Specifications are typical. Mechanical outline has been fixed. Engineering samples and/or test data may be available. Commitment to produce in volume is not guaranteed.

• **North America** Tel: 800.366.2266 / Fax: 978.366.2266
 • **Europe** Tel: 44.1908.574.200 / Fax: 44.1908.574.300
 • **Asia/Pacific** Tel: 81.44.844.8296 / Fax: 81.44.844.8298
 Visit www.macomtech.com for additional data sheets and product information.

M/A-COM Technology Solutions Inc. and its affiliates reserve the right to make changes to the product(s) or information contained herein without notice.

GaAs Chip Specification @ $T_{AMB} = +25^{\circ}C$

Part Number	Max. Rev. Volt. ¹ $V_R < 10 \mu A$ V_{DC}	Max. Cap. 1 MHz $C_j @ -10 V$ pF	Max. Series Res. ² 1 GHz $R_S @ 20 mA$ Ω	Nominal Characteristics	
				Carrier Lifetime $T_L @ I_{FOR} = 10 mA$ $I_{REV} = 6 mA$ ηS	Switching Speed ³ 7 GHz ηS
MA4GP022-277	50	0.15	1.0	5	15
MA4GP030-277	100	0.06	2.0	10	25

Notes:

- V_R (Reverse Voltage) is sourced and the resultant reverse leakage current, I_r , is measured to be $<10\mu A$.
- Chip is mounted into case style ODS 30 ceramic package.
- Switching speed is measured between 1 dB and 20 dB loss in a shunt mounted switch

Case Style 277 (Chip)

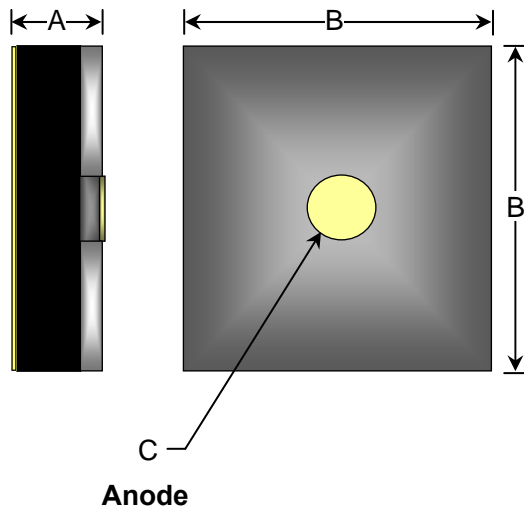

Dimension	Mils	Millimeters
A	$7 \pm .5$	$.178 \pm .013$
B	11 ± 1	$.279 \pm .025$
C	$2.2 \pm .3$	$.056 \pm .008$

Typical TTL Driver Circuit

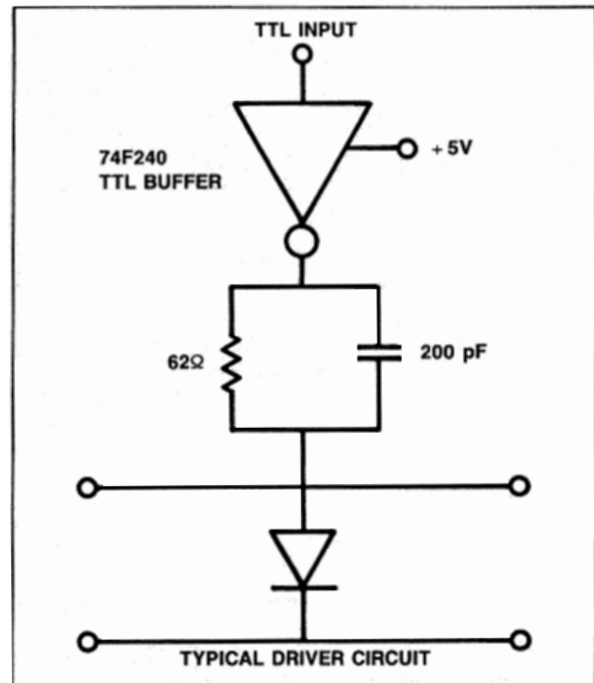

Typical Performance @ $T_{AMB} = +25^{\circ}\text{C}$

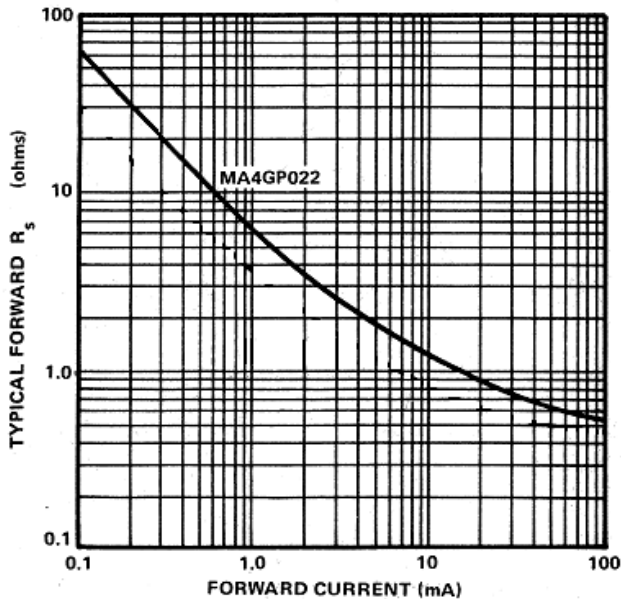

FIGURE 1. Typical Forward R_S vs. Forward Current at 1 GHz

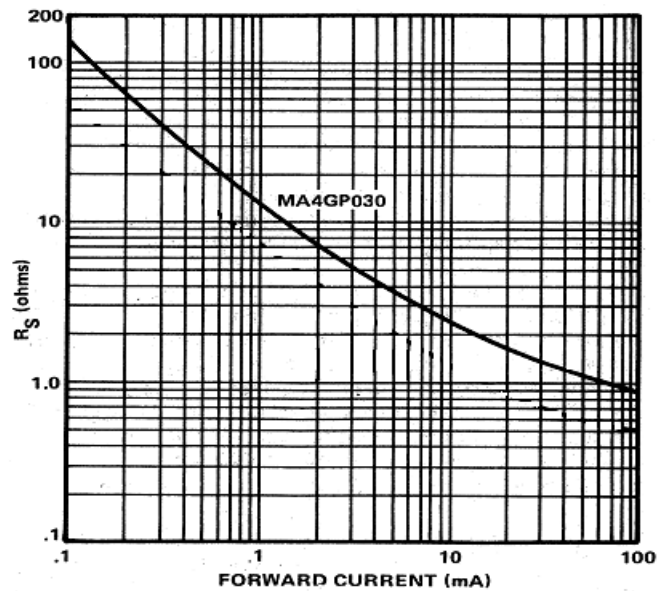

FIGURE 2. Typical Forward R_S vs. Forward Current at 1 GHz

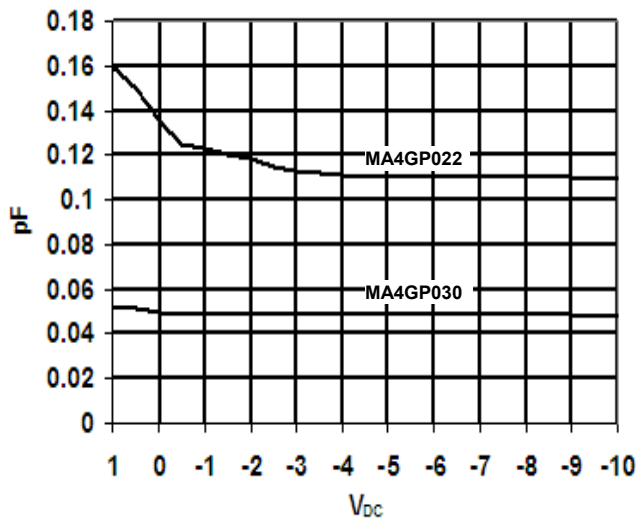

Figure 3. Typical Capacitance vs. Voltage at 1 GHz

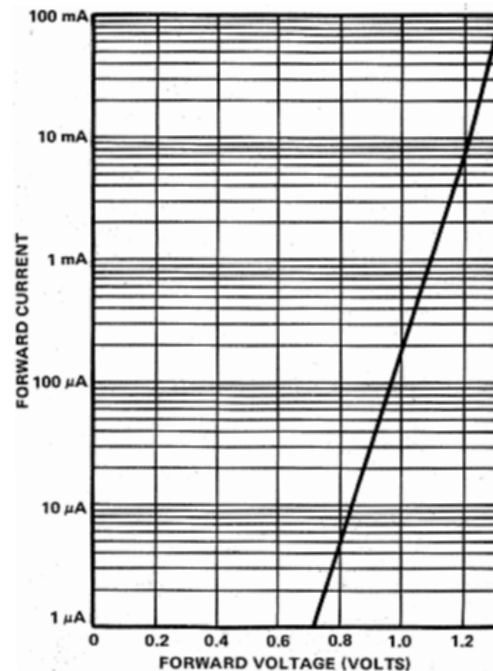

FIGURE 4. Typical Characteristics at 25°C Forward Current vs. Forward Voltage (All GaAs PIN Diodes)

Ordering Information

The GaAs Chip specifications shown in the table on page 2 are for the stand alone die, package style 277. Note that the table lists the bare die junction capacitance and that the total capacitance for the base part in an alternative package will differ. The total capacitance in an alternative package can be computed by adding the capacitance shown in the table on page 2 to the parasitic capacitance of the alternative package as defined in the **Package Parasitic Capacitance** table below. The base part numbers are only available in the case styles shown in the **Package Availability Table** below. To order, indicate the base part number followed by a dash and the desired package style.

For example: The MA4GP030-30 is the MA4GP030 chip in the 30 style package.

Package Parasitic Capacitance

Package Style	Inductance (nH)	Cap. (pF)
30	0.40	0.18
120	0.40	0.13
137	0.40	0.13
276	0.40	0.13
277	N/A (Chip)	N/A (Chip)
1056	0.20	0.20

Package Availability Table

Base Part Number	Available Package Styles
MA4GP022	137, 277
MA4GP030	30, 120, 276, 277, 1056

Style 120

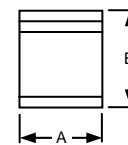

Dimension	Mils	Millimeters
A	53 ± 2	1346 ± 51
B	45 ± 5	1143 ± 127

Style 30

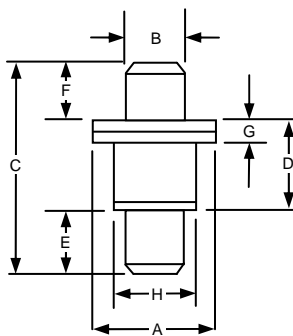

Dimension	Mils	Millimeters
A	121 ± 4	3073 ± 102
B	62 ± 2	1575 ± 51
C	215 ± 10	5461 ± 254
D	91 ± 6	2311 ± 152
E	62 ± 2	1575 ± 51
F	62 ± 2	1575 ± 51
G	20 ± 4	508 ± 102
H	81 ± 2	2057 ± 51

Style 137

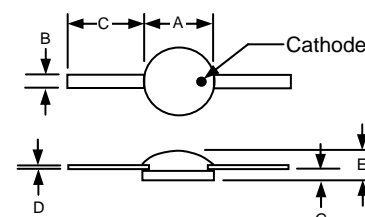

Dimension	Mils	Millimeters
A	100 ± 10	2540 ± 254
B	20 ± 2	508 ± 51
C	100 ± 5	2540 ± 127
D	4 ± 1	102 ± 25
E	50 max.	1270 max.
F		
G	14 max.	356 max.

ADVANCED: Data Sheets contain information regarding a product M/A-COM Technology Solutions is considering for development. Performance is based on target specifications, simulated results, and/or prototype measurements. Commitment to develop is not guaranteed.

PRELIMINARY: Data Sheets contain information regarding a product M/A-COM Technology Solutions has under development. Performance is based on engineering tests. Specifications are typical. Mechanical outline has been fixed. Engineering samples and/or test data may be available. Commitment to produce in volume is not guaranteed.

• **North America** Tel: 800.366.2266 / Fax: 978.366.2266

• **Europe** Tel: 44.1908.574.200 / Fax: 44.1908.574.300

• **Asia/Pacific** Tel: 81.44.844.8296 / Fax: 81.44.844.8298

Visit www.macomtech.com for additional data sheets and product information.

M/A-COM Technology Solutions Inc. and its affiliates reserve the right to make changes to the product(s) or information contained herein without notice.

Package Styles

Style 137

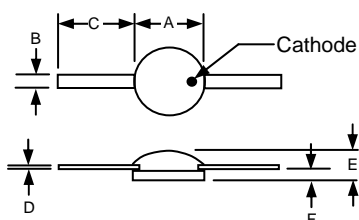

Dimension	Mils	Millimeters
A	100 ± 10	2540 ± 254
B	20 ± 2	508 ± 51
C	100 ± 5	2540 ± 127
D	4 ± 1	102 ± 25
E	50 max.	1270 max.
F	14 max.	356 max.

Style 1056

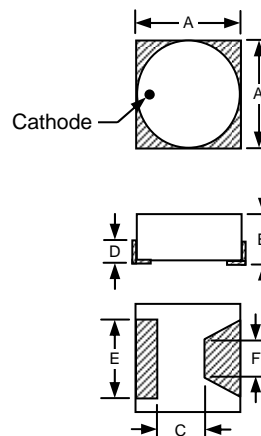

Dimension	Mils	Millimeters
A	70 ± 5	1778 ± 127
B	37 ± 4	940 ± 102
C	33 ± 3	838 ± 76
D	15 ± 2	381 ± 51
E	12 ± 2	305 ± 51
F	48 ± 5	1219 ± 127

Style 276

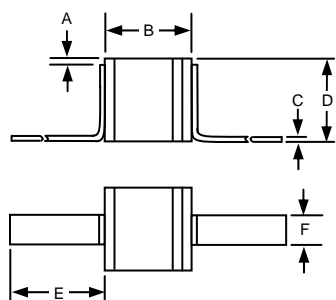

Dimension	Mils	Millimeters
A	15 ± 5	381 ± 127
B	45 ± 5	1143 ± 127
C	5 max.	127 max.
D	53 ± 2	1346 ± 51
E	200 min.	5080 min.
F	20 ± 1	508 ± 25

Die Handling and Mounting Information

Handling: All semiconductor chips should be handled with care to avoid damage or contamination from perspiration, salts, and skin oils. The use of plastic tipped tweezers or vacuum pickups is strongly recommended for individual components. Bulk handling should ensure that abrasion and mechanical shock are minimized.

Die Attach Surface: Die can be mounted with an 80Au/Sn20, eutectic solder preform or electrically conductive silver epoxy. The metal RF and D.C. ground plane mounting surface must be free of contamination and should have a surface flatness of $< \pm 0.002$ ".

Eutectic Die Attachment Using Hot Gas Die Bonder: A work surface temperature of 255°C is recommended. When hot forming gas is applied, the work area temperature should be approximately 290°C. The chip should not be exposed to temperatures greater than 320°C for more than 10 seconds.

Eutectic Die Attachment Using Reflow Oven: See [Application Note M541](#), "Bonding and Handling Procedures for Chip Diode Devices" at www.macom.com for recommended time-temperature profile.

Electrically Conductive Epoxy Die Attachment: A controlled amount of electrically conductive, silver epoxy, approximately 1–2 mils in thickness, should be used to minimize ohmic and thermal resistance. A thin epoxy fillet should be visible around the perimeter of the chip after placement to ensure full area coverage. Cure conductive epoxy per manufacturer's schedule. Typically 150°C for 1 hour.

Wire and Ribbon Bonding: It is recommended that thermo-compression or thermo-sonic bonding be used with little or no ultrasonics. The bonding tool and wire or ribbon used should be smaller than the anode contact diameter. A bonder heat stage temperature setting of 200°C, tool tip temperature of 150°C and a force of 18 to 50 grams is suggested. If ultrasonic scrubbing is necessary it should be adjusted to the minimum required to achieve a good bond. Excessive energy may cause the anode metallization to separate from the chip.

For more detailed handling and assembly instructions, see [Application Note M541](#), "Bonding and Handling Procedures for Chip Diode Devices" at www.macom.com.