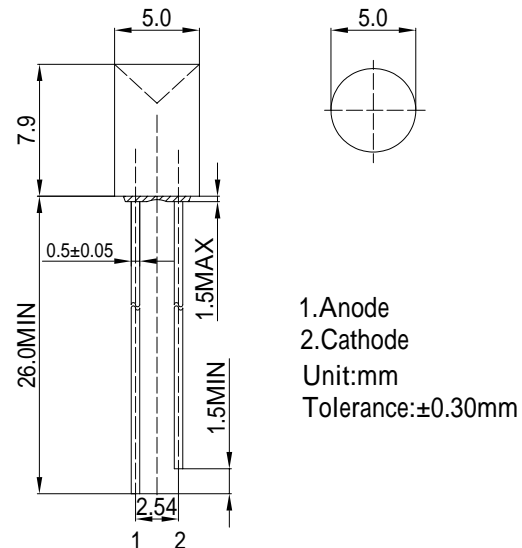

**■Features**

- High Luminous LEDs
- 5mm Concave Standard Directivity
- Superior Weather-resistance
- UV Resistant Epoxy
- Water Clear Type

**■Applications**

- Traffic signal, Portable light source
- Signage and channel letter
- Decorating and entertainment lighting
- Architectural lighting
- Outdoor/Indoor applications/Other Lighting

**■Outline Dimension**

**■Absolute Maximum Rating**

(Ta=25 °C)

Item	Symbol	Value	Unit
DC Forward Current	$I_F$	50	mA
Pulse Forward Current*	$I_{FP}$	120	mA
Reverse Voltage	$V_R$	5	V
Power Dissipation	$P_D$	120	mW
Operating Temperature	$T_{opr}$	-40~+85	
Storage Temperature	$T_{stg}$	-40 ~ +100	
Lead Soldering Temperature	$T_{sol}$	260 /5sec	-

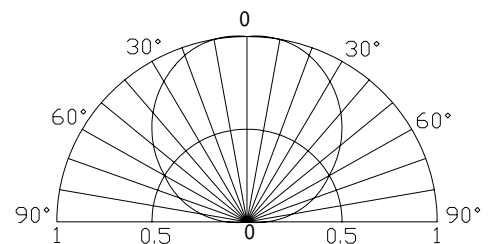
\*Pulse width Max.10ms , Duty ratio max 1/10

**■Directivity**

**■Electrical -Optical Characteristics**

(Ta=25 °C)

Item	Symbol	Condition	Min.	Typ.	Max.	Unit
DC Forward Voltage	$V_F$	$I_F=20mA$	1.8	2.1	2.4	V
DC Reverse Current	$I_R$	$V_R=5V$	-	-	10	$\mu A$
Domi. Wavelength*	$\lambda_D$	$I_F=20mA$	619	624	629	nm
Luminous Intensity*	$I_v$	$I_F=20mA$	-	180	-	mcd
50% Power Angle	$2\theta_{1/2}$	$I_F=20mA$	-	120	-	deg

 \*1 Tolerance of dominant wavelength is  $\pm 1nm$ 

 \*2 Tolerance of luminous intensity is  $\pm 15\%$ 
**Maximum Forward Current**
