



Shanghai Lunsure Electronic
Technology Co.,Ltd
Tel:0086-21-37185008
Fax:0086-21-57152769

1N4942GP THRU 1N4948GP

1 Amp Glass Passivated Fast Recovery Rectifier 200 - 1000 Volts

Features

- Low Leakage Current
- Metalurgically Bonded Construction
- Low Cost
- Fast Switching For High Efficiency
- Glass Passivated Junction

Maximum Ratings

- Operating Temperature: -55°C to +150°C
- Storage Temperature: -55°C to +150°C
- Maximum Thermal Resistance; 50°C/W Junction To Ambient

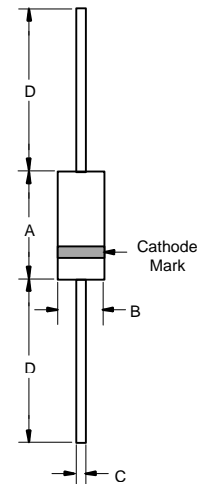
| Microsemi Catalog Number | Device Marking | Maximum Recurrent Peak Reverse Voltage | Maximum RMS Voltage | Maximum DC Blocking Voltage |
|--------------------------|----------------|--|---------------------|-----------------------------|
| 1N4942GP | --- | 200V | 140V | 200V |
| 1N4944GP | --- | 400V | 280V | 400V |
| 1N4946GP | --- | 600V | 420V | 600V |
| 1N4947GP | --- | 800V | 560V | 800V |
| 1N4948GP | --- | 1000V | 700V | 1000V |

Electrical Characteristics @ 25°C Unless Otherwise Specified

| | | | |
|---|-------------|--|---|
| Average Forward Current | $I_{F(AV)}$ | 1.0A | $T_A = 55^\circ\text{C}$ |
| Peak Forward Surge Current | I_{FSM} | 25A | 8.3ms, half sine |
| Maximum Instantaneous Forward Voltage | V_F | 1.3V | $I_{FM} = 1.0\text{A}; T_A = 25^\circ\text{C}^*$ |
| Maximum DC Reverse Current At Rated DC Blocking Voltage | I_R | 5.0 μA 200 μA | $T_J = 25^\circ\text{C}$ $T_J = 150^\circ\text{C}$ |
| Maximum Reverse Recovery Time | T_{rr} | 150ns 250ns 500ns | $I_F=0.5\text{A},$ $I_R=1.0\text{A},$ $I_{rr}=0.25\text{A}$ |
| 1N4942-4944 | | | |
| 1N4946-4947 1N4948 | | | |
| Typical Junction Capacitance | C_J | 15pF | Measured at 1.0MHz, $V_R=4.0\text{V}$ |

*Pulse test: Pulse width 300 μsec , Duty cycle 2%

DO-41

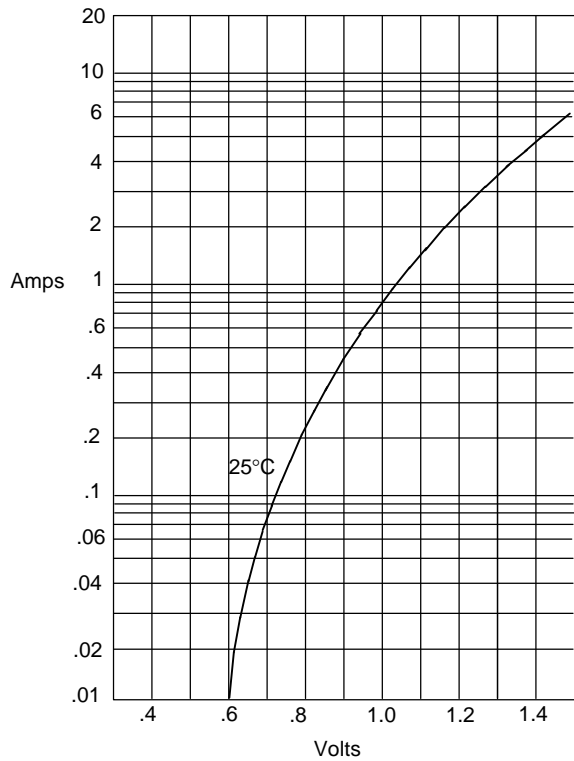


| DIM | INCHES | | MM | | NOTE |
|-----|--------|------|-------|------|------|
| | MIN | MAX | MIN | MAX | |
| A | .166 | .205 | 4.10 | 5.20 | |
| B | .080 | .107 | 2.00 | 2.70 | |
| C | .028 | .034 | .70 | .90 | |
| D | 1.000 | --- | 25.40 | --- | |

1N4942GP thru 1N4948GP

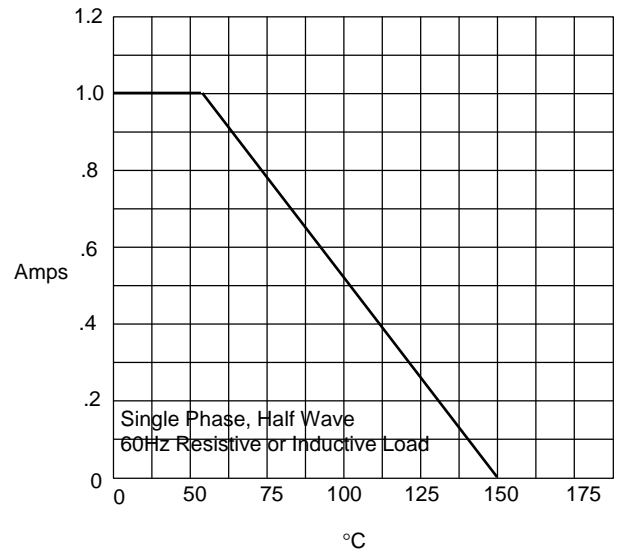


Figure 1
Typical Forward Characteristics



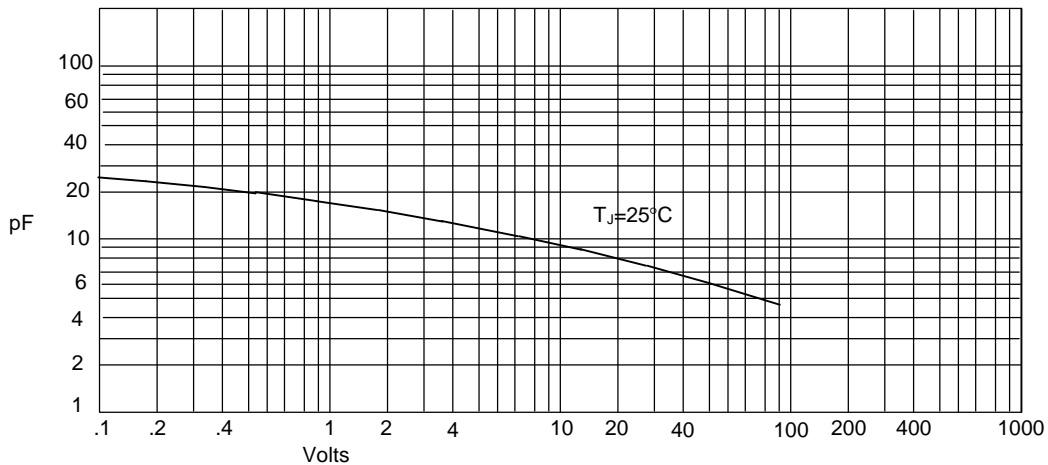
Instantaneous Forward Current - Amperes *versus*
Instantaneous Forward Voltage - Volts

Figure 2
Forward Derating Curve



Average Forward Rectified Current - Amperes *versus*
Ambient Temperature - °C

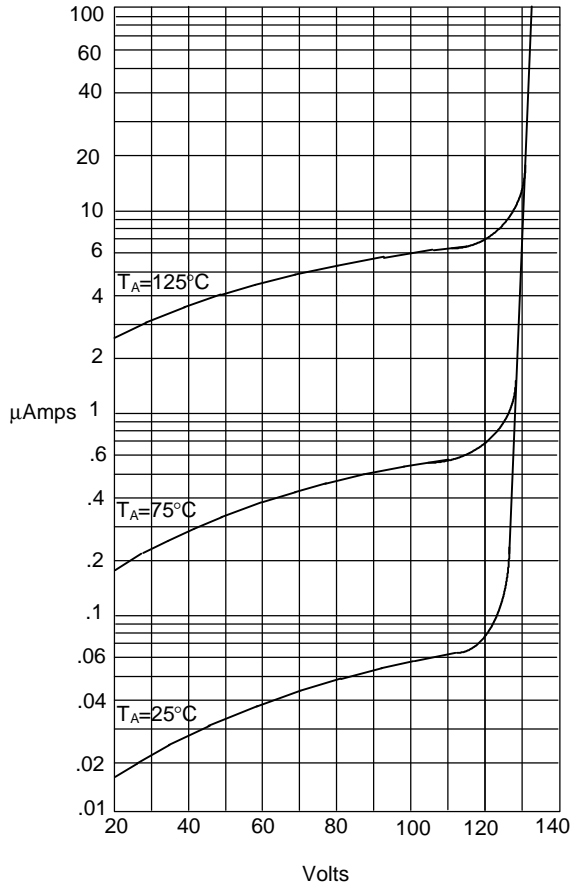
Figure 3
Junction Capacitance



Junction Capacitance - pF *versus*
Reverse Voltage - Volts

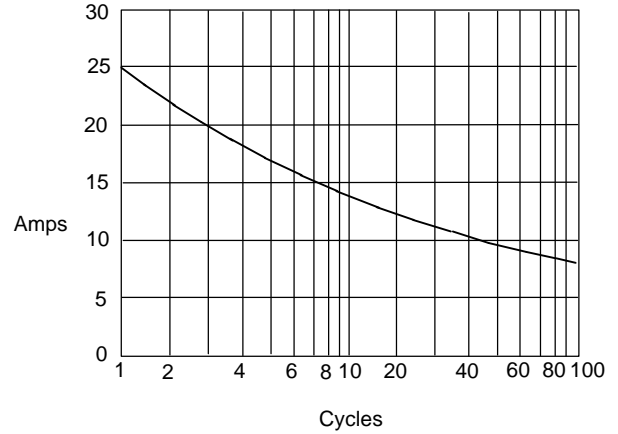


Figure 4
Typical Reverse Characteristics



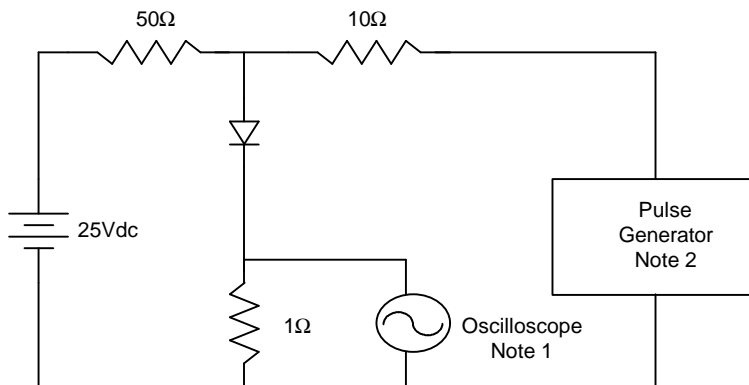
Instantaneous Reverse Leakage Current - MicroAmperes versus
Percent Of Rated Peak Reverse Voltage - Volts

Figure 5
Non-Repetitive Peak Forward Surge Current



Peak Forward Surge Current - Amperes versus
Number Of Cycles At 60Hz - Cycles

Figure 6
Reverse Recovery Time Characteristic And Test Circuit Diagram



- Notes:
1. Rise Time = 7ns max.
Input impedance = 1 megohm, 22pF
 2. Rise Time = 10ns max.
Source impedance = 50 ohms
 3. Resistors are non-inductive

