



CHENMKO ENTERPRISE CO.,LTD

CH3904WPT

**SURFACE MOUNT
NPN Switching Transistor**

VOLTAGE 40 Volts CURRENT 0.2 Ampere

Lead free devices

APPLICATION

- * Telephony and professional communication equipment.
- * Other switching applications.

FEATURE

- * Small surface mounting type. (SC-70/SOT-323)
- * Low current (Max.=200mA).
- * Suitable for high packing density.
- * Low voltage (Max.=40V) .
- * High saturation current capability.
- * Voltage controlled small signal switch.

CONSTRUCTION

- * NPN Switching Transistor

MARKING

- * NG

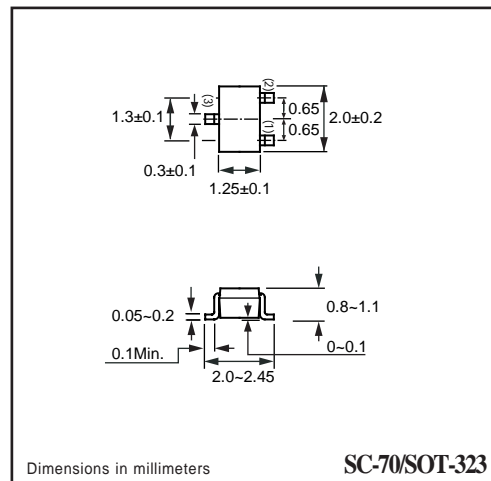
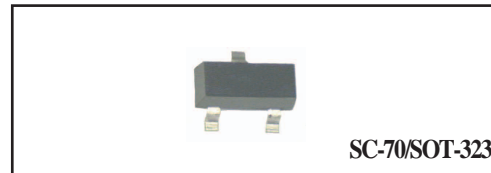

CIRCUIT

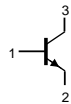

LIMITING VALUES

In accordance with the Absolute Maximum Rating System (IEC 60134).

SYMBOL	PARAMETER	CONDITIONS	MIN.	MAX.	UNIT
V _{CB0}	collector-base voltage	open emitter	-	60	V
V _{CEO}	collector-emitter voltage	open base	-	40	V
V _{EBO}	emitter-base voltage	open collector	-	6	V
I _C	collector current DC		-	200	mA
I _{CM}	peak collector current		-	200	mA
I _{BM}	peak base current		-	100	mA
P _{tot}	total power dissipation	T _{amb} ≤ 25 °C; note 1	-	250	mW
T _{stg}	storage temperature		-65	+150	°C
T _j	junction temperature		-	150	°C
T _{amb}	operating ambient temperature		-65	+150	°C

Note

1. Transistor mounted on an FR4 printed-circuit board.

RATING CHARACTERISTIC CURVES (CH3904WPT)

THERMAL CHARACTERISTICS

SYMBOL	PARAMETER	CONDITIONS	VALUE	UNIT
$R_{th\ j-a}$	thermal resistance from junction to ambient	note 1	500	K/W

Note

1. Transistor mounted on an FR4 printed-circuit board.

CHARACTERISTICS

$T_{amb} = 25\text{ °C}$ unless otherwise specified.

SYMBOL	PARAMETER	CONDITIONS	MIN.	MAX.	UNIT
I_{CBO}	collector cut-off current	$I_E = 0; V_{CB} = 30\text{ V}$	–	50	nA
I_{EBO}	emitter cut-off current	$I_C = 0; V_{EB} = 6\text{ V}$	–	50	nA
h_{FE}	DC current gain	$V_{CE} = 1\text{ V}$; note 1 $I_C = 0.1\text{ mA}$ $I_C = 1\text{ mA}$ $I_C = 10\text{ mA}$ $I_C = 50\text{ mA}$ $I_C = 100\text{ mA}$	60 80 100 60 30	– – 300 – –	
V_{CEsat}	collector-emitter saturation voltage	$I_C = 10\text{ mA}; I_B = 1\text{ mA}$	–	200	mV
		$I_C = 50\text{ mA}; I_B = 5\text{ mA}$	–	300	mV
V_{BEsat}	base-emitter saturation voltage	$I_C = 10\text{ mA}; I_B = 1\text{ mA}$	650	850	mV
		$I_C = 50\text{ mA}; I_B = 5\text{ mA}$	–	950	mV
C_c	collector capacitance	$I_E = i_e = 0; V_{CB} = 5\text{ V}; f = 1\text{ MHz}$	–	4	pF
C_e	emitter capacitance	$I_C = i_c = 0; V_{BE} = 500\text{ mV}; f = 1\text{ MHz}$	–	8	pF
f_T	transition frequency	$I_C = 10\text{ mA}; V_{CE} = 20\text{ V}; f = 100\text{ MHz}$	300	–	MHz
F	noise figure	$I_C = 100\text{ }\mu\text{A}; V_{CE} = 5\text{ V}; R_S = 1\text{ k}\Omega; f = 10\text{ Hz to }15.7\text{ kHz}$	–	5	dB

Switching times (between 10% and 90% levels);

t_{on}	turn-on time	$I_{Con} = 10\text{ mA}; I_{Bon} = 1\text{ mA}; I_{Boff} = -1\text{ mA}$	–	65	ns
t_d	delay time		–	35	ns
t_r	rise time		–	35	ns
t_{off}	turn-off time		–	240	ns
t_s	storage time		–	200	ns
t_f	fall time		–	50	ns

Note

1. Pulse test: $t_p \leq 300\text{ }\mu\text{s}$; $\delta \leq 0.02$.

RATING CHARACTERISTIC CURVES (CH3904WPT)

Total power dissipation $P_{tot} = f(T_S)$

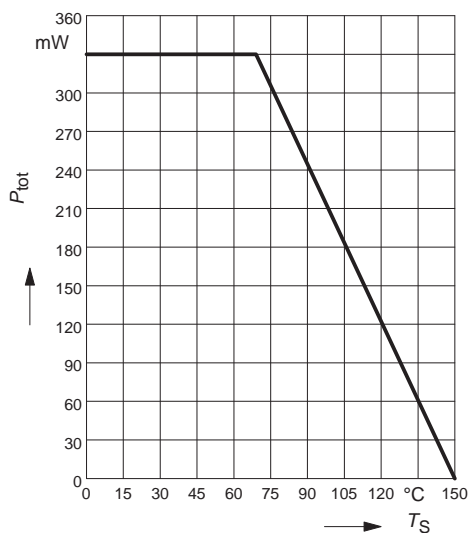

Saturation voltage $I_C = f(V_{BEsat}, V_{CEsat})$

$h_{FE} = 10$

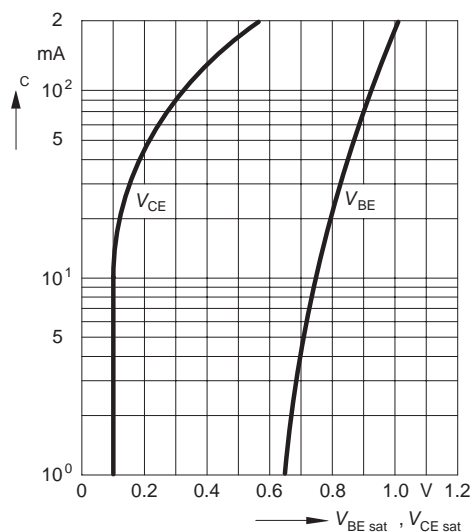

Permissible pulse load

$P_{totmax} / P_{totDC} = f(t_p)$

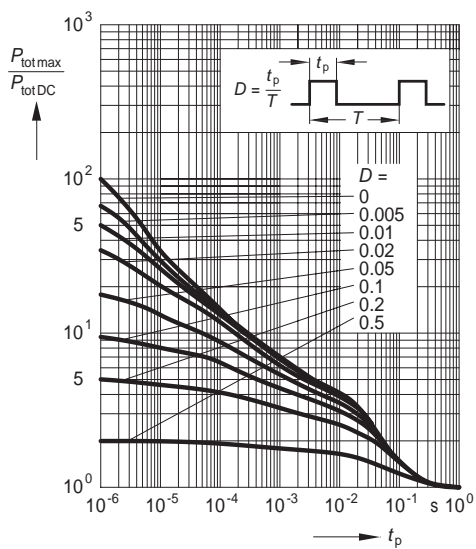

DC current gain $h_{FE} = f(I_C)$

$V_{CE} = 10V$, normalized

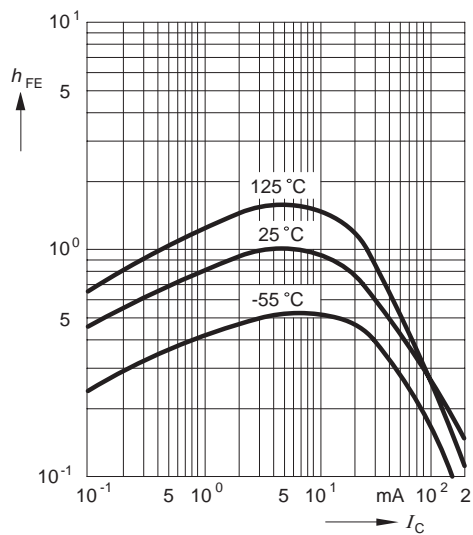

RATING CHARACTERISTIC CURVES (CH3904WPT)

Short-circuit forward current

transfer ratio $h_{21e} = f(I_C)$

$V_{CE} = 10V, f = 1MHz$

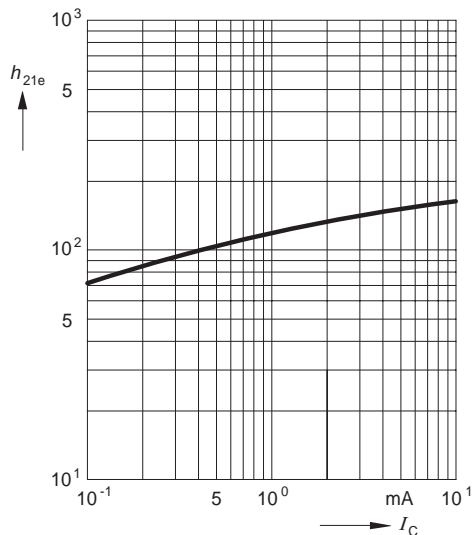

Open-circuit output admittance

$h_{22e} = f(I_C)$

$V_{CE} = 10V, f = 1MHz$

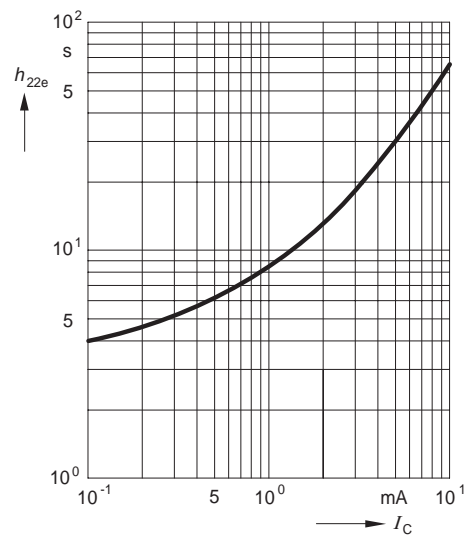

Delay time $t_d = f(I_C)$

Rise time $t_r = f(I_C)$

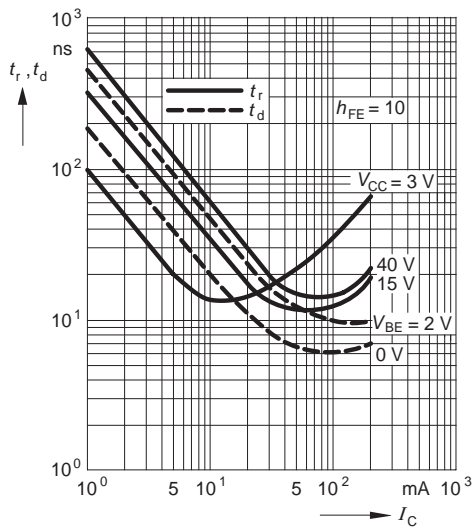

Storage time $t_{stg} = f(I_C)$

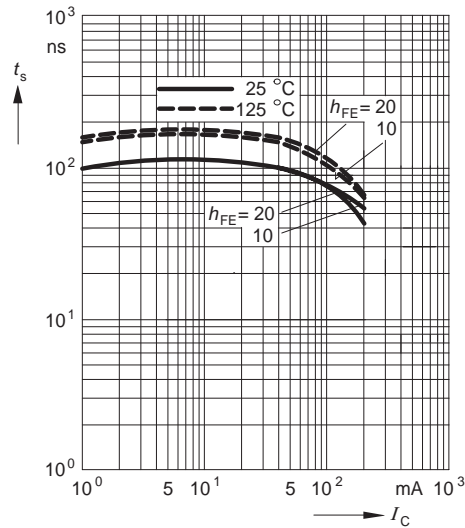

RATING CHARACTERISTIC CURVES (CH3904WPT)

Fall time $t_f = f(I_C)$

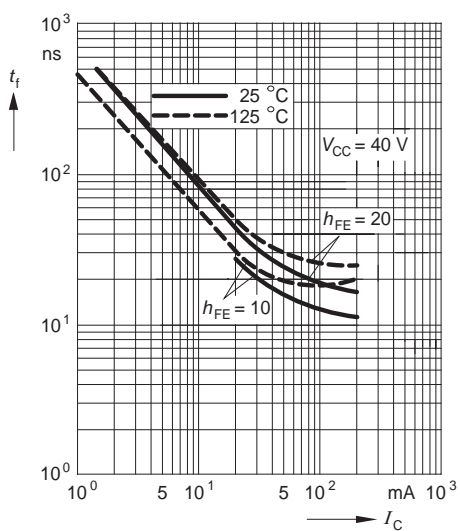

Rise time $t_r = f(I_C)$

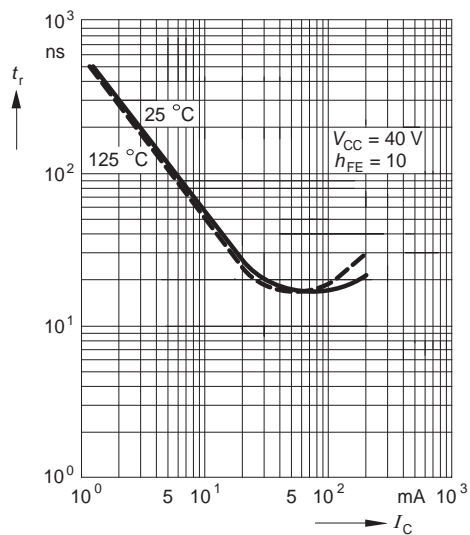

Input impedance

$h_{11e} = f(I_C)$

$V_{CE} = 10\text{ V}, f = 1\text{ kHz}$

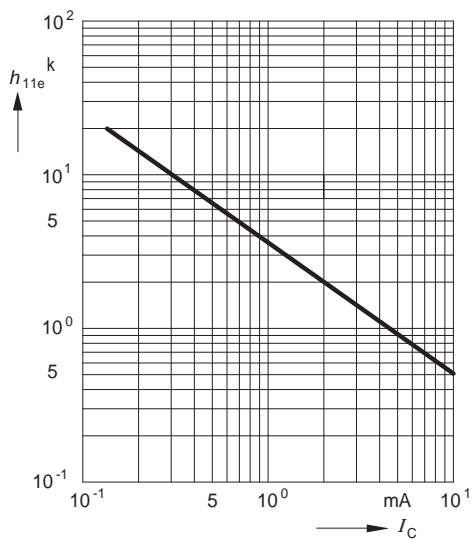

Open-circuit reverse voltage

transfer ratio $h_{12e} = f(I_C)$

$V_{CE} = 10\text{ V}, f = 1\text{ kHz}$

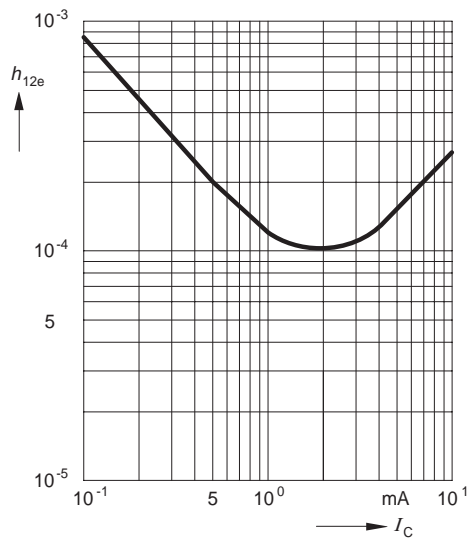

RATING CHARACTERISTIC CURVES (CH3904WPT)

Test circuits

Delay and rise time

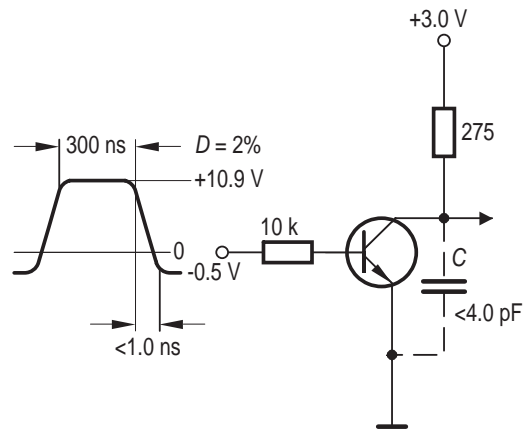

Storage and fall time

