

Features

- Very high speed: 45 ns
- Temperature ranges
 - Industrial: -40°C to +85°C
 - Automotive-A: -40°C to +85°C
 - Automotive-E: -40°C to +125°C
- Wide voltage range: 2.20V to 3.60V
- Pin compatible with CY62147DV30
- Ultra low standby power
 - Typical standby current: 1 μ A
 - Maximum standby current: 7 μ A (Industrial)
- Ultra low active power
 - Typical active current: 2 mA at f = 1 MHz
- Easy memory expansion with \overline{CE} [1] and \overline{OE} features
- Automatic power down when deselected
- CMOS for optimum speed and power
- Available in Pb-free 48-ball VFBGA (single/dual CE option) and 44-pin TSOPII packages
- Byte power down feature

Functional Description

The CY62147EV30 is a high performance CMOS static RAM organized as 256K words by 16 bits. This device features advanced circuit design to provide ultra low active current. It is

ideal for providing More Battery Life™ (MoBL[®]) in portable applications such as cellular telephones. The device also has an automatic power down feature that significantly reduces power consumption when addresses are not toggling. Placing the device into standby mode reduces power consumption by more than 99% when deselected (\overline{CE} HIGH or both BLE and BHE are HIGH). The input and output pins (IO₀ through IO₁₅) are placed in a high impedance state when:

- Deselected (\overline{CE} HIGH)
- Outputs are disabled (\overline{OE} HIGH)
- Both Byte High Enable and Byte Low Enable are disabled (BHE, BLE HIGH)
- Write operation is active (\overline{CE} LOW and \overline{WE} LOW)

To write to the device, take Chip Enable (\overline{CE}) and Write Enable (\overline{WE}) inputs LOW. If Byte Low Enable (\overline{BLE}) is LOW, then data from IO pins (IO₀ through IO₇) is written into the location specified on the address pins (A₀ through A₁₇). If Byte High Enable (\overline{BHE}) is LOW, then data from IO pins (IO₈ through IO₁₅) is written into the location specified on the address pins (A₀ through A₁₇).

To read from the device, take Chip Enable (\overline{CE}) and Output Enable (\overline{OE}) LOW while forcing the Write Enable (\overline{WE}) HIGH. If Byte Low Enable (\overline{BLE}) is LOW, then data from the memory location specified by the address pins appear on IO₀ to IO₇. If Byte High Enable (\overline{BHE}) is LOW, then data from memory appears on IO₈ to IO₁₅. See the Truth Table on page 9 for a complete description of read and write modes.

For best practice recommendations, refer to the Cypress application note [AN1064, SRAM System Guidelines](#).

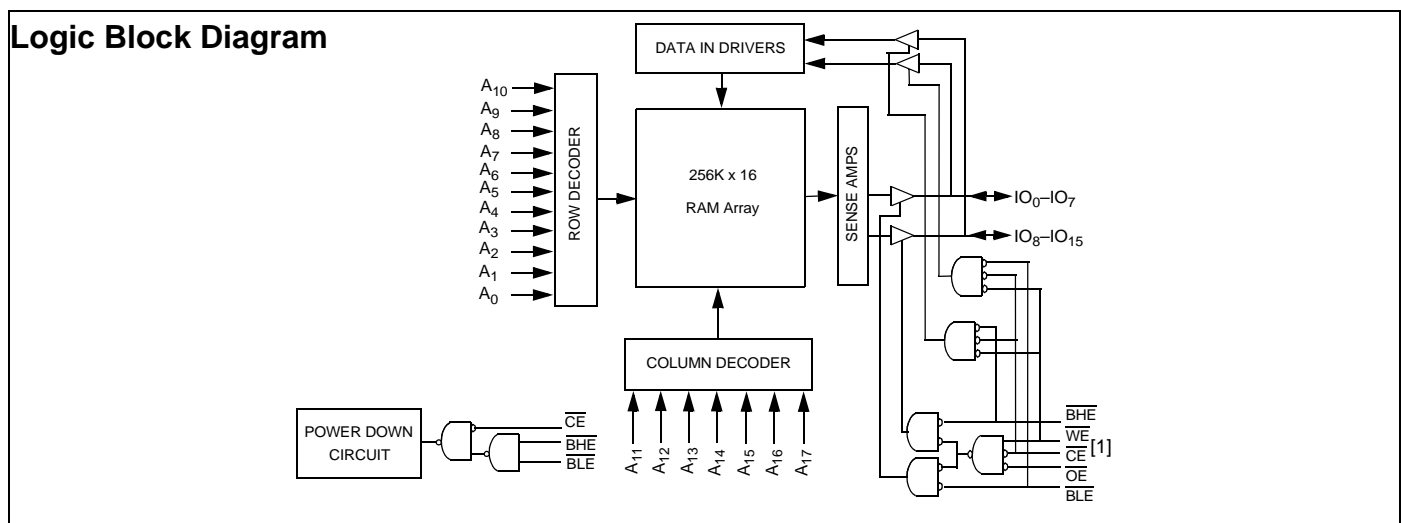

Note

1. BGA packaged device is offered in single CE and dual CE options. In this data sheet, for a dual CE device, \overline{CE} refers to the internal logical combination of \overline{CE}_1 and \overline{CE}_2 such that when \overline{CE}_1 is LOW and \overline{CE}_2 is HIGH, \overline{CE} is LOW. For all other cases \overline{CE} is HIGH.

Product Portfolio

Product	Range	V _{CC} Range (V)			Speed (ns)	Power Dissipation					
						Operating I _{CC} (mA)				Standby I _{SB2} (μA)	
						f = 1 MHz		f = f _{max}			
Min	Typ ^[2]	Max	Typ ^[2]	Max	Typ ^[2]	Max	Typ ^[2]	Max			
CY62147EV30LL	Ind'I/Auto-A	2.2	3.0	3.6	45 ns	2	2.5	15	20	1	7
	Auto-E	2.2	3.0	3.6	55 ns	2	3	15	25	1	20

Pin Configuration

Figure 1. 48-Ball VFBGA (Single Chip Enable)^[3, 4]

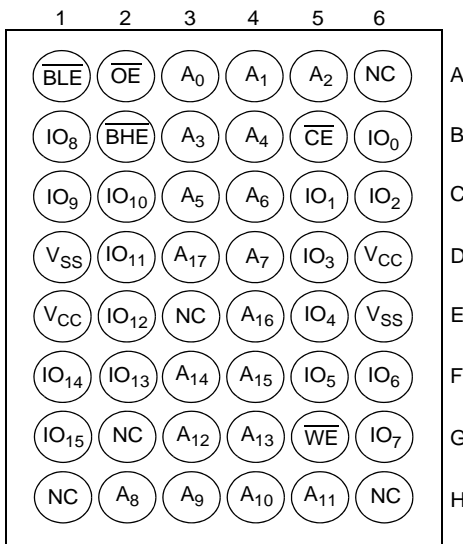

Figure 2. 48-Ball VFBGA (Dual Chip Enable)^[3, 4]

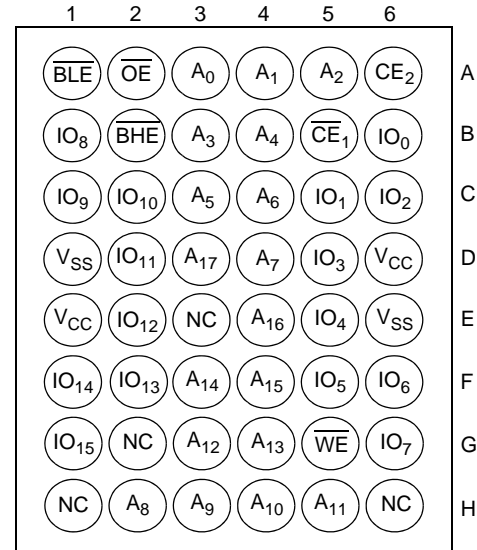
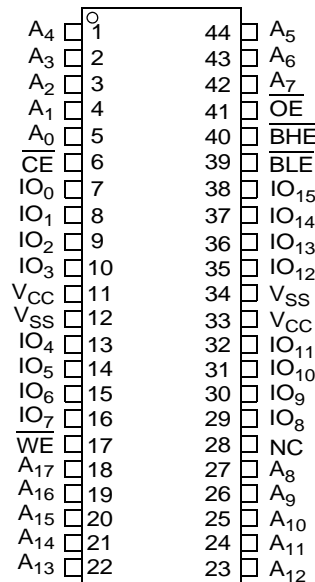

Figure 3. 44-Pin TSOP II^[3]



Notes

- Typical values are included for reference only and are not guaranteed or tested. Typical values are measured at V_{CC} = V_{CC(typ)}, T_A = 25°.
- NC pins are not connected on the die.
- Pins H1, G2, and H6 in the BGA package are address expansion pins for 8 Mb, 16 Mb, and 32 Mb, respectively.

Maximum Ratings

Exceeding the maximum ratings may impair the useful life of the device. User guidelines are not tested.

Storage Temperature	-65°C to + 150°C
Ambient Temperature with Power Applied	-55°C to + 125°C
Supply Voltage to Ground Potential	-0.3V to + 3.9V ($V_{CCmax} + 0.3V$)
DC Voltage Applied to Outputs in High-Z State ^[5, 6]	-0.3V to 3.9V ($V_{CCmax} + 0.3V$)

DC Input Voltage ^[5, 6]	-0.3V to 3.9V ($V_{CCmax} + 0.3V$)
Output Current into Outputs (LOW)	20 mA
Static Discharge Voltage	>2001V (MIL-STD-883, Method 3015)
Latch Up Current	>200 mA

Operating Range

Device	Range	Ambient Temperature	V_{CC} ^[7]
CY62147EV30LL	Ind'I/Auto-A	-40°C to +85°C	2.2V to 3.6V
	Auto-E	-40°C to +125°C	

Electrical Characteristics

Over the Operating Range

Parameter	Description	Test Conditions	45 ns (Ind'I/Auto-A)			55 ns (Auto-E)			Unit
			Min	Typ ^[2]	Max	Min	Typ ^[2]	Max	
V_{OH}	Output HIGH Voltage	$I_{OH} = -0.1$ mA	2.0			2.0			V
		$I_{OH} = -1.0$ mA, $V_{CC} \geq 2.70V$	2.4			2.4			V
V_{OL}	Output LOW Voltage	$I_{OL} = 0.1$ mA			0.4			0.4	V
		$I_{OL} = 2.1$ mA, $V_{CC} = 2.70V$			0.4			0.4	V
V_{IH}	Input HIGH Voltage	$V_{CC} = 2.2V$ to 2.7V	1.8		$V_{CC} + 0.3$	1.8		$V_{CC} + 0.3$	V
		$V_{CC} = 2.7V$ to 3.6V	2.2		$V_{CC} + 0.3$	2.2		$V_{CC} + 0.3$	V
V_{IL}	Input LOW Voltage	$V_{CC} = 2.2V$ to 2.7V	-0.3		0.6	-0.3		0.6	V
		$V_{CC} = 2.7V$ to 3.6V	-0.3		0.8	-0.3		0.8	V
I_{IX}	Input Leakage Current	$GND \leq V_I \leq V_{CC}$	-1		+1	-4		+4	μA
I_{OZ}	Output Leakage Current	$GND \leq V_O \leq V_{CC}$, Output Disabled	-1		+1	-4		+4	μA
I_{CC}	V_{CC} Operating Supply Current	$f = f_{max} = 1/t_{RC}$		15	20		15	25	mA
		$f = 1$ MHz		2	2.5		2	3	
I_{SB1}	Automatic CE Power Down Current — CMOS Inputs	$\overline{CE} \geq V_{CC} - 0.2V$ $V_{IN} \geq V_{CC} - 0.2V$, $V_{IN} \leq 0.2V$ $f = f_{max}$ (Address and Data Only), $f = 0$ (OE, BHE, BLE and WE), $V_{CC} = 3.60V$		1	7		1	20	μA
I_{SB2} ^[8]	Automatic CE Power Down Current — CMOS Inputs	$\overline{CE} \geq V_{CC} - 0.2V$ $V_{IN} \geq V_{CC} - 0.2V$ or $V_{IN} \leq 0.2V$, $f = 0$, $V_{CC} = 3.60V$		1	7		1	20	μA

Capacitance

For all packages. ^[9]

Parameter	Description	Test Conditions	Max	Unit
C_{IN}	Input Capacitance	$T_A = 25^\circ C$, $f = 1$ MHz,	10	pF
C_{OUT}	Output Capacitance	$V_{CC} = V_{CC}(typ)$		

Notes

- $V_{IL(min)}$ = -2.0V for pulse durations less than 20 ns.
- $V_{IH(max)}$ = $V_{CC} + 0.75V$ for pulse durations less than 20 ns.
- Full device AC operation assumes a minimum of 100 μs ramp time from 0 to $V_{CC(min)}$ and 200 μs wait time after V_{CC} stabilization.
- Only chip enable (CE) and byte enables (BHE and BLE) need to be tied to CMOS levels to meet the I_{SB2} / I_{CCDR} spec. Other inputs can be left floating.
- Tested initially and after any design or process changes that may affect these parameters.

Thermal Resistance^[9]

Parameter	Description	Test Conditions	VFBGA Package	TSOP II Package	Unit
Θ_{JA}	Thermal Resistance (Junction to Ambient)	Still Air, soldered on a 3 x 4.5 inch, two-layer printed circuit board	75	77	°C/W
Θ_{JC}	Thermal Resistance (Junction to Case)		10	13	°C/W

Figure 4. AC Test Load and Waveforms

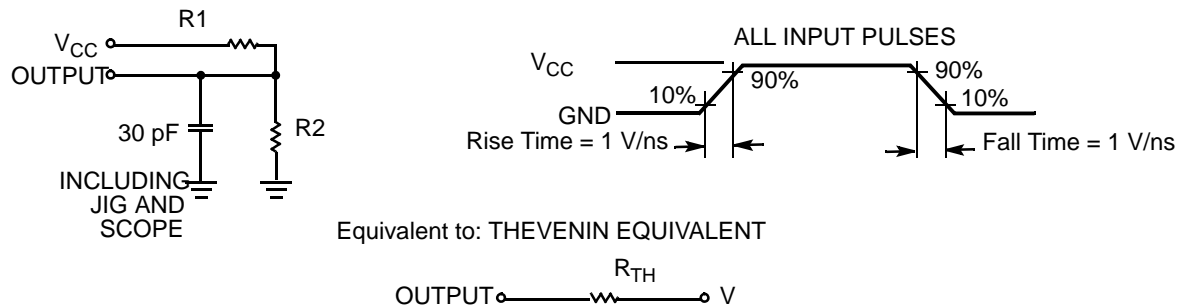

Parameters	2.50V	3.0V	Unit
R1	16667	1103	Ω
R2	15385	1554	Ω
R_{TH}	8000	645	Ω
V_{TH}	1.20	1.75	V

Data Retention Characteristics

Over the Operating Range

Parameter	Description	Conditions	Min	Typ ^[2]	Max	Unit
V_{DR}	V_{CC} for Data Retention		1.5			V
$I_{CCDR}^{[8]}$	Data Retention Current	$V_{CC} = 1.5V, \overline{CE} \geq V_{CC} - 0.2V,$ $V_{IN} \geq V_{CC} - 0.2V$ or $V_{IN} \leq 0.2V$		0.8	7	μA
		Ind'I/Auto-A			12	
		Auto-E				
$t_{CDR}^{[9]}$	Chip Deselect to Data Retention Time		0			ns
$t_R^{[10]}$	Operation Recovery Time		t_{RC}			ns

Figure 5. Data Retention Waveform^[1, 11]

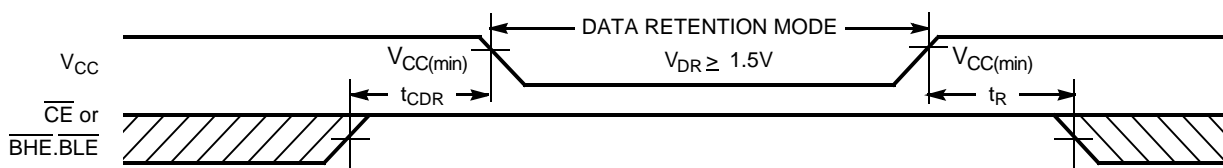

Notes

10. Full device operation requires linear V_{CC} ramp from V_{DR} to $V_{CC(min)} \geq 100 \mu s$ or stable at $V_{CC(min)} \geq 100 \mu s$.

11. BHE.BLE is the AND of both BHE and BLE. Deselect the chip by either disabling the chip enable signals or by disabling both BHE and BLE.

Switching Characteristics

Over the Operating Range ^[12, 13]

Parameter	Description	45 ns (Ind'I/Auto-A)		55 ns (Auto-E)		Unit
		Min	Max	Min	Max	
Read Cycle						
t _{RC}	Read Cycle Time	45		55		ns
t _{AA}	Address to Data Valid		45		55	ns
t _{OHA}	Data Hold from Address Change	10		10		ns
t _{ACE}	\overline{CE} LOW to Data Valid		45		55	ns
t _{DOE}	\overline{OE} LOW to Data Valid		22		25	ns
t _{LZOE}	\overline{OE} LOW to Low Z ^[14]	5		5		ns
t _{HZOE}	\overline{OE} HIGH to High Z ^[14, 15]		18		20	ns
t _{LZCE}	\overline{CE} LOW to Low Z ^[14]	10		10		ns
t _{HZCE}	\overline{CE} HIGH to High Z ^[14, 15]		18		20	ns
t _{PU}	\overline{CE} LOW to Power Up	0		0		ns
t _{PD}	\overline{CE} HIGH to Power Down		45		55	ns
t _{DBE}	$\overline{BLE}/\overline{BHE}$ LOW to Data Valid		45		55	ns
t _{LZBE}	$\overline{BLE}/\overline{BHE}$ LOW to Low Z ^[14]	10		10		ns
t _{HZBE}	$\overline{BLE}/\overline{BHE}$ HIGH to HIGH Z ^[14, 15]		18		20	ns
Write Cycle^[16]						
t _{WC}	Write Cycle Time	45		55		ns
t _{SCE}	\overline{CE} LOW to Write End	35		40		ns
t _{AW}	Address Setup to Write End	35		40		ns
t _{HA}	Address Hold from Write End	0		0		ns
t _{SA}	Address Setup to Write Start	0		0		ns
t _{PWE}	\overline{WE} Pulse Width	35		40		ns
t _{BW}	$\overline{BLE}/\overline{BHE}$ LOW to Write End	35		40		ns
t _{SD}	Data Setup to Write End	25		25		ns
t _{HD}	Data Hold from Write End	0		0		ns
t _{HZWE}	\overline{WE} LOW to High-Z ^[14, 15]		18		20	ns
t _{LZWE}	\overline{WE} HIGH to Low-Z ^[14]	10		10		ns

Notes

12. Test conditions for all parameters other than tri-state parameters assume signal transition time of 3 ns (1V/ns) or less, timing reference levels of $V_{CC(typ)}/2$, input pulse levels of 0 to $V_{CC(typ)}$, and output loading of the specified I_{OL}/I_{OH} as shown in the [AC Test Load and Waveforms](#) on page 4.
13. AC timing parameters are subject to byte enable signals (BHE or BLE) not switching when chip is disabled. See application note [AN13842](#) for further clarification.
14. At any temperature and voltage condition, t_{HZCE} is less than t_{LZCE}, t_{HZBE} is less than t_{LZBE}, t_{HZOE} is less than t_{LZOE}, and t_{HZWE} is less than t_{LZWE} for any device.
15. t_{HZOE}, t_{HZCE}, t_{HZBE}, and t_{HZWE} transitions are measured when the outputs enter a high impedance state.
16. The internal write time of the memory is defined by the overlap of \overline{WE} , $\overline{CE} = V_{IL}$, \overline{BHE} , \overline{BLE} , or both = V_{IL} . All signals must be active to initiate a write and any of these signals can terminate a write by going inactive. The data input setup and hold timing must be referenced to the edge of the signal that terminates the write.

Switching Waveforms

Figure 6. Read Cycle No. 1 (Address Transition Controlled)^[17, 18]

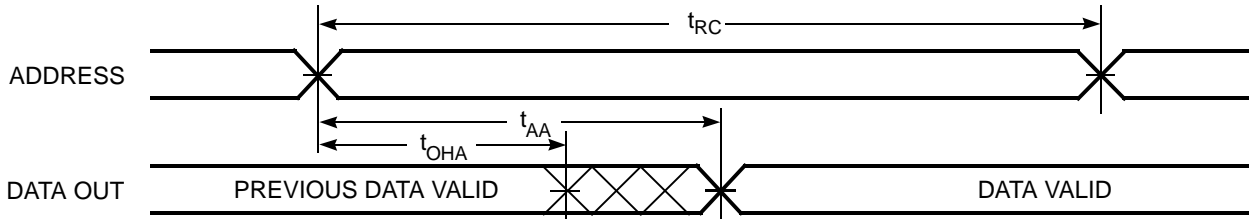
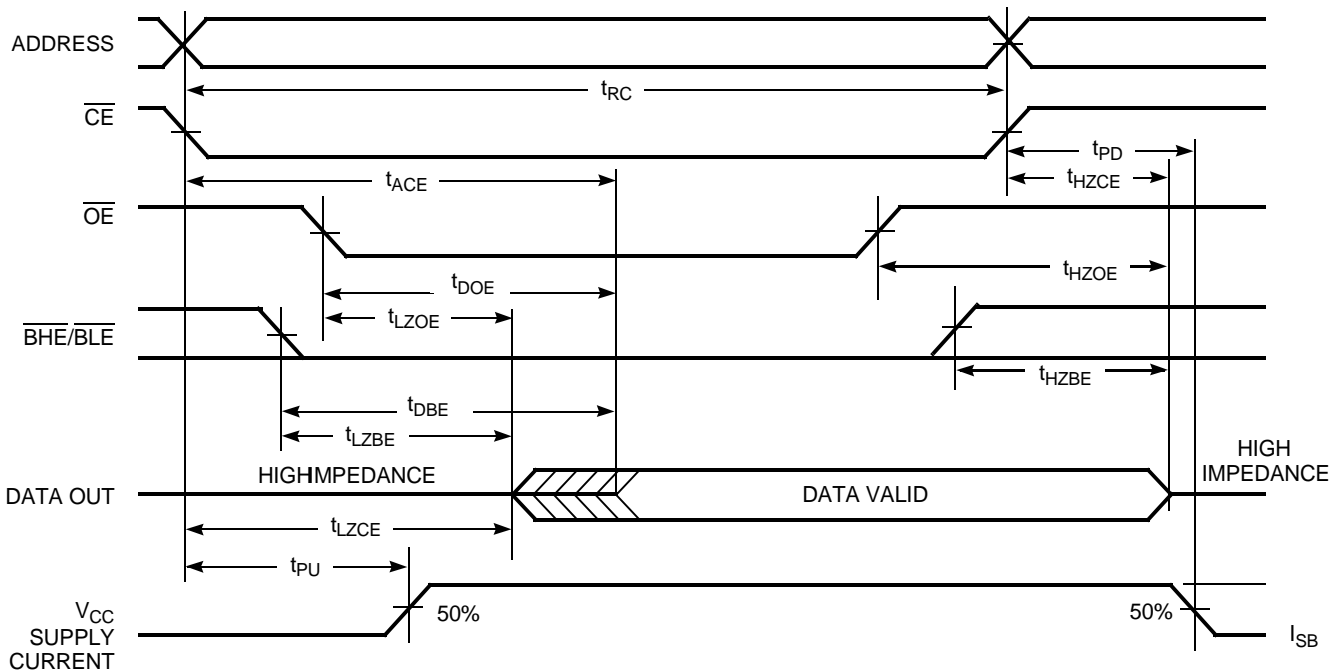

Figure 7. Read Cycle No. 2 (\overline{OE} Controlled)^[1, 18, 19]



Notes

17. The device is continuously selected. \overline{OE} , $\overline{CE} = V_{IL}$, \overline{BHE} , \overline{BLE} , or both = V_{IL} .
18. \overline{WE} is HIGH for read cycle.
19. Address valid before or similar to \overline{CE} and \overline{BHE} , \overline{BLE} transition LOW.

Switching Waveforms (continued)

Figure 8. Write Cycle No. 1 (\overline{WE} Controlled)^[1, 16, 20, 21]

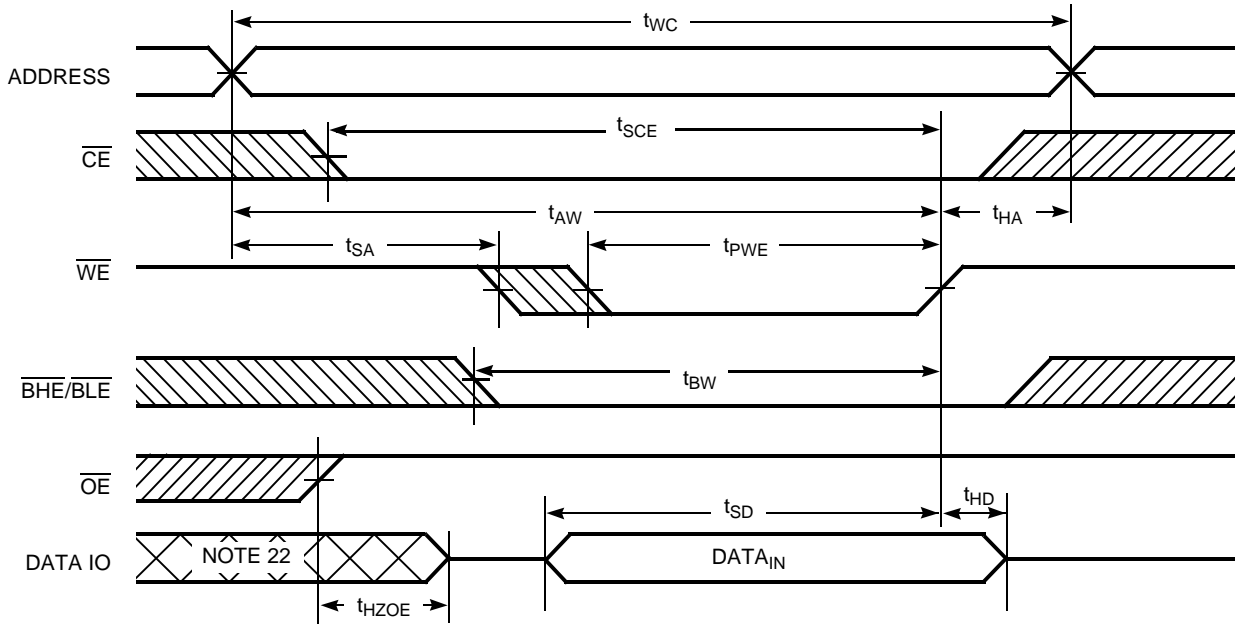
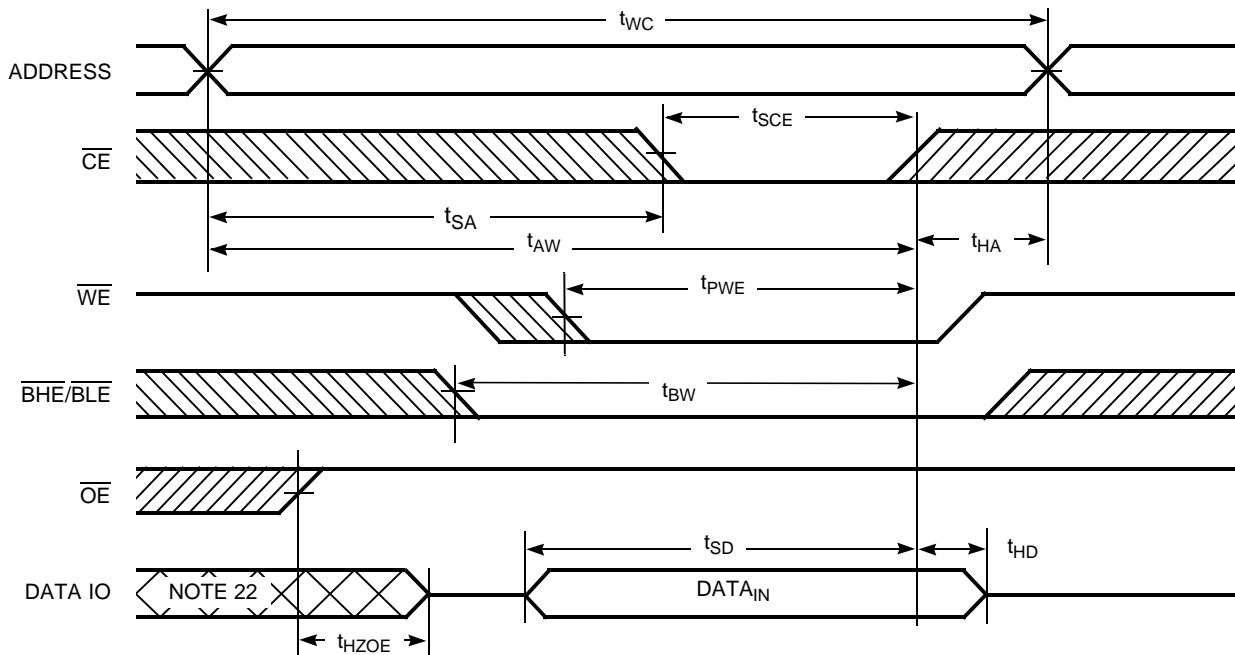

Figure 9. Write Cycle No. 2 (\overline{CE} Controlled)^[1, 16, 20, 21]



Switching Waveforms (continued)

Figure 10. Write Cycle No. 3 (\overline{WE} Controlled, \overline{OE} LOW)^[1, 21]

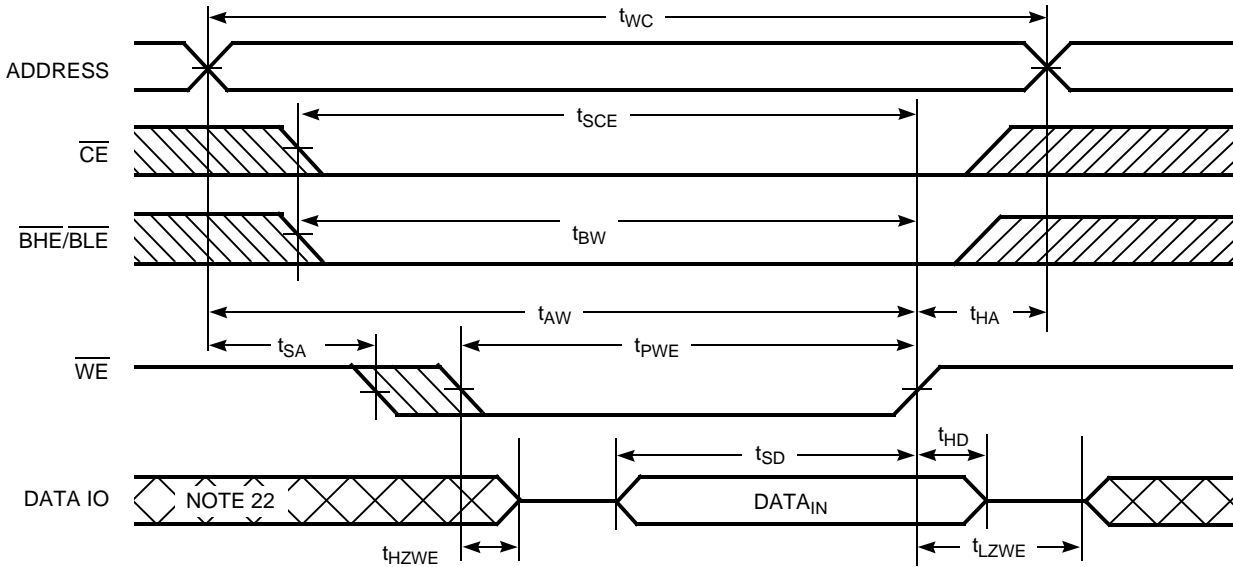
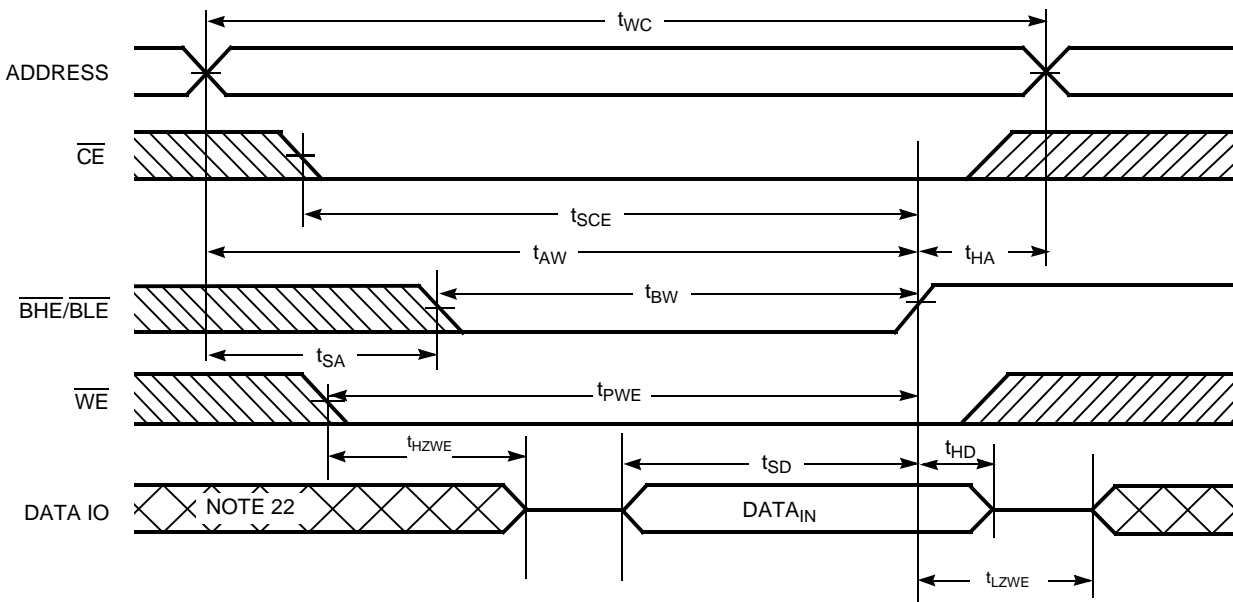

Figure 11. Write Cycle No. 4 ($\overline{BHE}/\overline{BLE}$ Controlled, \overline{OE} LOW)^[1, 21]



Notes

- 20. Data I/O is high impedance if $\overline{OE} = V_{IH}$.
- 21. If \overline{CE} goes HIGH simultaneously with $\overline{WE} = V_{IH}$, the output remains in a high impedance state.
- 22. During this period, the IOs are in output state. Do not apply input signals.

Truth Table

$\overline{CE}^{[1]}$	\overline{WE}	\overline{OE}	\overline{BHE}	\overline{BLE}	IOs	Mode	Power
H	X	X	X	X	High Z	Deselect/Power Down	Standby (I_{SB})
L	X	X	H	H	High Z	Deselect/Power Down	Standby (I_{SB})
L	H	L	L	L	Data Out (IO_0 – IO_{15})	Read	Active (I_{CC})
L	H	L	H	L	Data Out (IO_0 – IO_7); IO_8 – IO_{15} in High Z	Read	Active (I_{CC})
L	H	L	L	H	Data Out (IO_8 – IO_{15}); IO_0 – IO_7 in High Z	Read	Active (I_{CC})
L	H	H	L	L	High Z	Output Disabled	Active (I_{CC})
L	H	H	H	L	High Z	Output Disabled	Active (I_{CC})
L	H	H	L	H	High Z	Output Disabled	Active (I_{CC})
L	L	X	L	L	Data In (IO_0 – IO_{15})	Write	Active (I_{CC})
L	L	X	H	L	Data In (IO_0 – IO_7); IO_8 – IO_{15} in High Z	Write	Active (I_{CC})
L	L	X	L	H	Data In (IO_8 – IO_{15}); IO_0 – IO_7 in High Z	Write	Active (I_{CC})

Ordering Information

Speed (ns)	Ordering Code	Package Diagram	Package Type	Operating Range
45	CY62147EV30LL-45BVI	51-85150	48-Ball Very Fine Pitch Ball Grid Array ^[23]	Industrial
	CY62147EV30LL-45BVXI	51-85150	48-Ball Very Fine Pitch Ball Grid Array (Pb-Free) ^[23]	
	CY62147EV30LL-45B2XI	51-85150	48-Ball Very Fine Pitch Ball Grid Array (Pb-Free) ^[24]	
	CY62147EV30LL-45ZSXI	51-85087	44-Pin Thin Small Outline Package II (Pb-Free)	Automotive-A
	CY62147EV30LL-45BVXA	51-85150	48-Ball Very Fine Pitch Ball Grid Array (Pb-Free) ^[23]	
	CY62147EV30LL-45ZSXA	51-85087	44-Pin Thin Small Outline Package II (Pb-Free)	
55	CY62147EV30LL-55ZSXE	51-85087	44-Pin Thin Small Outline Package II (Pb-Free)	Automotive-E

Contact your local Cypress sales representative for availability of these parts.

Notes

23. This BGA package is offered with single chip enable.

24. This BGA package is offered with dual chip enable.

Package Diagrams

Figure 12. 48-Ball VFBGA (6 x 8 x 1 mm), 51-85150

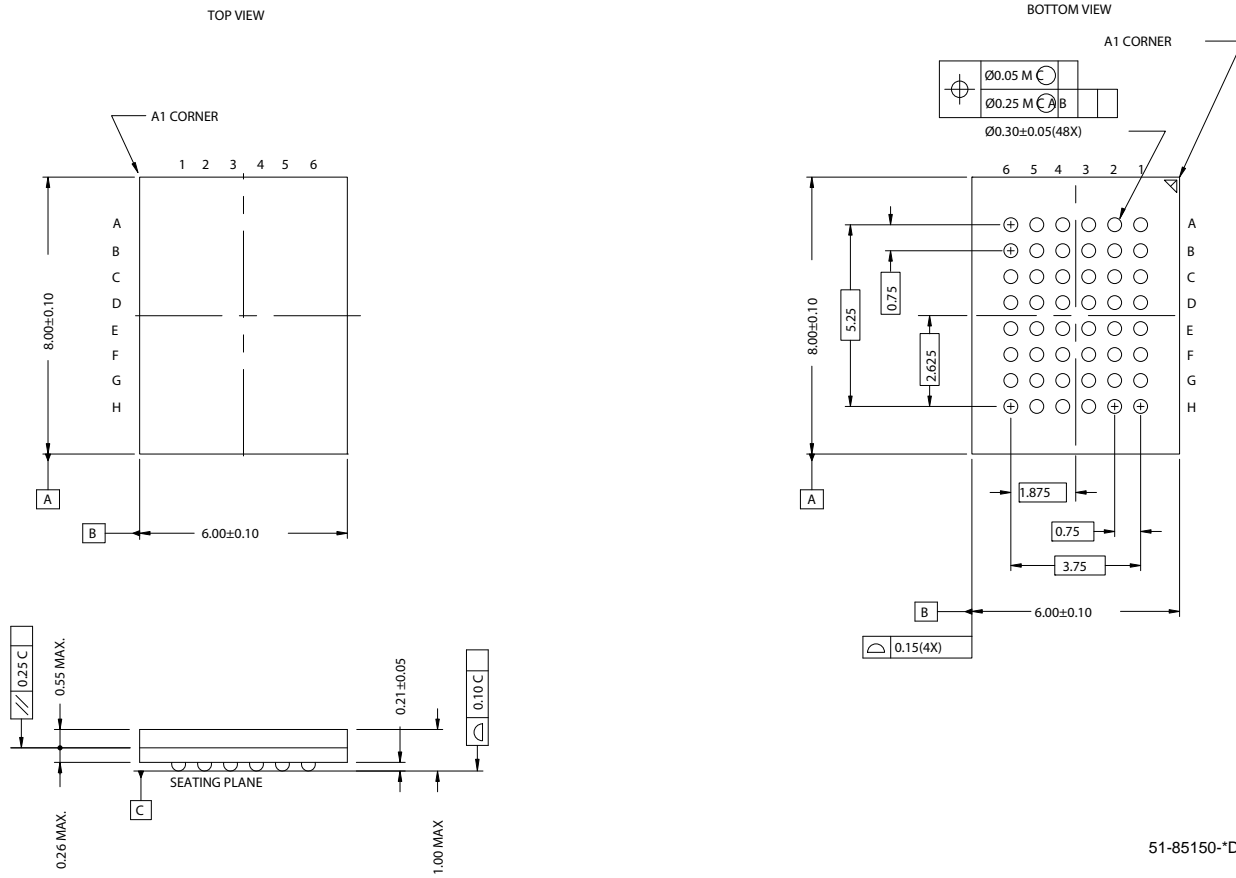

51-85150-*D

Package Diagrams (continued)

Figure 13. 44-Pin TSOP II, 51-85087

DIMENSION IN MM (INCH)
MAX
MIN

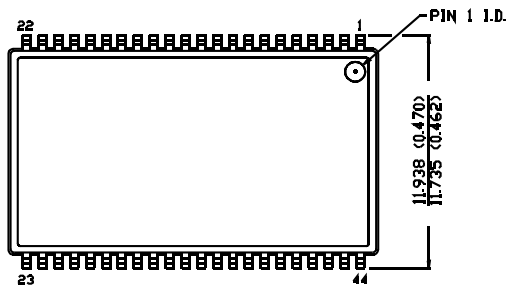

TOP VIEW

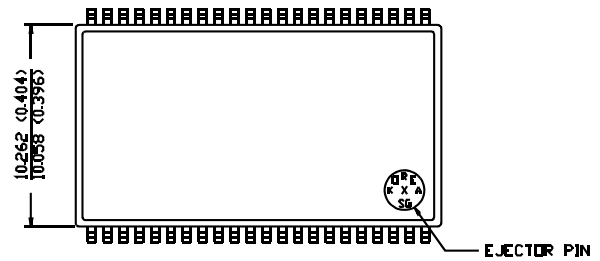

BOTTOM VIEW

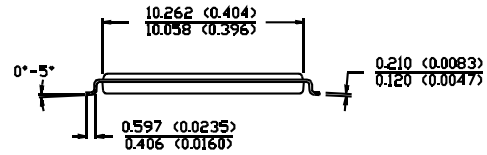
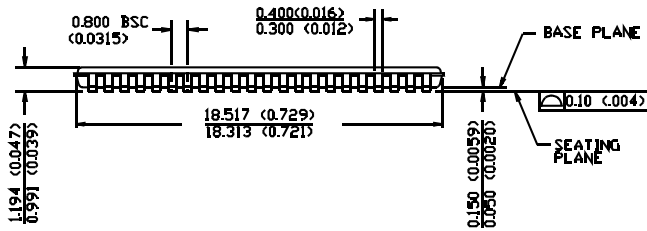

51-85087-A

Document History Page

Document Title: CY62147EV30 MoBL [®] 4-Mbit (256K x 16) Static RAM				
Document Number: 38-05440				
Rev.	ECN No.	Orig. of Change	Submission Date	Description of Change
**	201861	AJU	01/13/04	New Data Sheet
*A	247009	SYT	See ECN	<p>Changed from Advanced Information to Preliminary</p> <p>Moved Product Portfolio to Page 2</p> <p>Changed Vcc stabilization time in footnote #8 from 100 μs to 200 μs</p> <p>Removed Footnote #15(t_{LZBE}) from Previous Revision</p> <p>Changed I_{CCDR} from 2.0 μA to 2.5 μA</p> <p>Changed typo in Data Retention Characteristics(t_R) from 100 μs to t_{RC} ns</p> <p>Changed t_{OHA} from 6 ns to 10 ns for both 35 ns and 45 ns Speed Bin</p> <p>Changed t_{HZOE}, t_{HZBE}, t_{HZWE} from 12 to 15 ns for 35 ns Speed Bin and 15 to 18 ns for 45 ns Speed Bin</p> <p>Changed t_{SCE} and t_{BW} from 25 to 30 ns for 35 ns Speed Bin and 40 to 35 ns for 45 ns Speed Bin</p> <p>Changed t_{HZCE} from 12 to 18 ns for 35 ns Speed Bin and 15 to 22 ns for 45 ns Speed Bin</p> <p>Changed t_{SD} from 15 to 18 ns for 35 ns Speed Bin and 20 to 22 ns for 45 ns Speed Bin</p> <p>Changed t_{DOE} from 15 to 18 ns for 35 ns Speed Bin</p> <p>Changed Ordering Information to include Pb-Free Packages</p>
*B	414807	ZSD	See ECN	<p>Changed from Preliminary information to Final</p> <p>Changed the address of Cypress Semiconductor Corporation on Page #1 from "3901 North First Street" to "198 Champion Court"</p> <p>Removed 35ns Speed Bin</p> <p>Removed "L" version of CY62147EV30</p> <p>Changed ball E3 from DNU to NC.</p> <p>Removed redundant foot note on DNU.</p> <p>Changed I_{CC} (Max) value from 2 mA to 2.5 mA and I_{CC} (Typ) value from 1.5 mA to 2 mA at $f=1$ MHz</p> <p>Changed I_{CC} (Typ) value from 12 mA to 15 mA at $f = f_{max}$</p> <p>Changed I_{SB1} and I_{SB2} Typ values from 0.7 μA to 1 μA and Max values from 2.5 μA to 7 μA.</p> <p>Changed I_{CCDR} from 2.5 μA to 7 μA.</p> <p>Added I_{CCDR} typical value.</p> <p>Changed AC test load capacitance from 50 pF to 30 pF on Page #4.</p> <p>Changed t_{LZOE} from 3 ns to 5 ns</p> <p>Changed t_{LZCE}, t_{LZBE} and t_{LZWE} from 6 ns to 10 ns</p> <p>Changed t_{HZCE} from 22 ns to 18 ns</p> <p>Changed t_{PWE} from 30 ns to 35 ns.</p> <p>Changed t_{SD} from 22 ns to 25 ns.</p> <p>Updated the package diagram 48-pin VFBGA from *B to *D</p> <p>Updated the ordering information table and replaced the Package Name column with Package Diagram.</p>
*C	464503	NXR	See ECN	<p>Included Automotive Range in product offering</p> <p>Updated the Ordering Information</p>
*D	925501	VKN	See ECN	<p>Added Preliminary Automotive-A information</p> <p>Added footnote #9 related to I_{SB2} and I_{CCDR}</p> <p>Added footnote #14 related AC timing parameters</p>
*E	1045701	VKN	See ECN	Converted Automotive-A and Automotive -E specs from preliminary to final
*F	2577505	VKN/PYRS	10/03/08	Added -45B2XI part (Dual CE option)
*G	2681901	VKN/PYRS	04/01/09	Added CY62147EV30LL-45ZSXA in the ordering information table

Sales, Solutions, and Legal Information

Worldwide Sales and Design Support

Cypress maintains a worldwide network of offices, solution centers, manufacturer's representatives, and distributors. To find the office closest to you, visit us at cypress.com/sales.

Products

PSoC	psoc.cypress.com
Clocks & Buffers	clocks.cypress.com
Wireless	wireless.cypress.com
Memories	memory.cypress.com
Image Sensors	image.cypress.com

PSoC Solutions

General	psoc.cypress.com/solutions
Low Power/Low Voltage	psoc.cypress.com/low-power
Precision Analog	psoc.cypress.com/precision-analog
LCD Drive	psoc.cypress.com/lcd-drive
CAN 2.0b	psoc.cypress.com/can
USB	psoc.cypress.com/usb

© Cypress Semiconductor Corporation, 2007-2009. The information contained herein is subject to change without notice. Cypress Semiconductor Corporation assumes no responsibility for the use of any circuitry other than circuitry embodied in a Cypress product. Nor does it convey or imply any license under patent or other rights. Cypress products are not warranted nor intended to be used for medical, life support, life saving, critical control or safety applications, unless pursuant to an express written agreement with Cypress. Furthermore, Cypress does not authorize its products for use as critical components in life-support systems where a malfunction or failure may reasonably be expected to result in significant injury to the user. The inclusion of Cypress products in life-support systems application implies that the manufacturer assumes all risk of such use and in doing so indemnifies Cypress against all charges.

Any Source Code (software and/or firmware) is owned by Cypress Semiconductor Corporation (Cypress) and is protected by and subject to worldwide patent protection (United States and foreign), United States copyright laws and international treaty provisions. Cypress hereby grants to licensee a personal, non-exclusive, non-transferable license to copy, use, modify, create derivative works of, and compile the Cypress Source Code and derivative works for the sole purpose of creating custom software and or firmware in support of licensee product to be used only in conjunction with a Cypress integrated circuit as specified in the applicable agreement. Any reproduction, modification, translation, compilation, or representation of this Source Code except as specified above is prohibited without the express written permission of Cypress.

Disclaimer: CYPRESS MAKES NO WARRANTY OF ANY KIND, EXPRESS OR IMPLIED, WITH REGARD TO THIS MATERIAL, INCLUDING, BUT NOT LIMITED TO, THE IMPLIED WARRANTIES OF MERCHANTABILITY AND FITNESS FOR A PARTICULAR PURPOSE. Cypress reserves the right to make changes without further notice to the materials described herein. Cypress does not assume any liability arising out of the application or use of any product or circuit described herein. Cypress does not authorize its products for use as critical components in life-support systems where a malfunction or failure may reasonably be expected to result in significant injury to the user. The inclusion of Cypress' product in a life-support systems application implies that the manufacturer assumes all risk of such use and in doing so indemnifies Cypress against all charges.

Use may be limited by and subject to the applicable Cypress software license agreement.