



SANYO Semiconductors

DATA SHEET

LA1776M — Monolithic Linear IC Single-Chip Tuner IC for Car Radios

Overview

The LA1776M integrates all six blocks required in a car radio tuner on a single chip.

Functions

- FM front end
- FM IF
- Noise canceller
- Multiplex
- AM up-conversion
- FM/AM switch
- MRC

Feature

- Reduced noise in the mixer and amplifier blocks for improved performance
- Increased FM front end mixer dynamic range for improved three signal characteristics
- Improved AM practical sensitivity and saturated signal-to-noise ratio
- S-meter sample-to-sample variations can be improved by using the FM S-meter shift function (Fixed resistors can be used for the SD, keyed AGC, muting on adjustment, muting attenuation, SNC, and HCC.)
- High-speed searching can be implemented using the FM band mute time constant switching function.
- Superb listenability provided by improved medium and weak field noise canceller characteristics.
- Improved separation temperature dependency characteristics
- Excellent FM S-meter voltage linearity
- Noise rejection improved by modifications to the NC circuit
- Sample-to-sample variation correction circuit (zapping) in the FM IF circuit
- Stopping at stations with heavy interference is prevented by increasing the AM wide AGC sensitivity by 10 dB during seek operations
- Built-in anti-birdie filter

■ Any and all SANYO products described or contained herein do not have specifications that can handle applications that require extremely high levels of reliability, such as life-support systems, aircraft's control systems, or other applications whose failure can be reasonably expected to result in serious physical and/or material damage. Consult with your SANYO representative nearest you before using any SANYO products described or contained herein in such applications.

■ SANYO assumes no responsibility for equipment failures that result from using products at values that exceed, even momentarily, rated values (such as maximum ratings, operating condition ranges, or other parameters) listed in products specifications of any and all SANYO products described or contained herein.

SANYO Electric Co., Ltd. Semiconductor Company

TOKYO OFFICE Tokyo Bldg., 1-10, 1 Chome, Ueno, Taito-ku, TOKYO, 110-8534 JAPAN

Specifications

Maximum Ratings at $T_a = 25^\circ\text{C}$

Parameter	Symbol	Conditions	Ratings	Unit
Maximum supply voltage	$V_{CC1 \text{ max}}$	Pins 5, 40, and 61	9	V
	$V_{CC2 \text{ max}}$	Pins 9, 46, 54, 59, and 60	12	V
Allowable power dissipation	$P_d \text{ max}$	$T_a \leq 85^\circ\text{C}$	950	mW
Operating temperature	T_{opr}		-40 to +85	$^\circ\text{C}$
Storage temperature	T_{stg}		-40 to +150	$^\circ\text{C}$

Recommended Operating Conditions at $T_a = 25^\circ\text{C}$

Parameter	Symbol	Conditions	Ratings	Unit
Maximum Recommended supply voltage	V_{CC}	Pins 5, 9, 40, 46, 54, 59, 60, and 61	8	V
	$V_{CCST \text{ IND}}$	Pin 39	5	V
Operating supply voltage range	$V_{CC \text{ op}}$		7.5 to 8.5	V

Function List

FM Front End (Equivalent to the Sanyo LA1193)

- Double input type double balanced mixer, base injection
- Pin diode drive AGC output
- MOSFET second gate drive AGC output
- Keyed AGC adjustment pin
- Differential IF amplifier
- Wide band AGC sensitivity setting pin, and narrow band AGC sensitivity setting pin

FM IF

- IF limiter amplifier
- S-meter output (also used for AM) 6-stage pickup
- Multipath detection pin (shared FM signal meter)
- Quadrature detection
- AF preamplifier
- AGC output
- Band muting
- Soft muting adjustment pin
- Muting attenuation adjustment pin
- IF counter buffer output (also used for AM)
- SD (IF counter buffer on level) adjustment pin
- SD output (active high) (also used for AM)
- Time constant switching during band muting
- S-meter shifter

Noise Canceller

- High-pass filter (first order)
- Delay circuit based low-pass filter (fourth order)
- Noise AGC
- Pilot signal compensation circuit
- Noise sensitivity setting pin
- Function for disabling the noise canceller in AM mode

Multiplex Functions

- Adjustment-free VCO circuit
- Level follower type pilot canceller circuit
- HCC (high cut control)
- Automatic stereo/mono switching
- VCO oscillation stop function (AM mode)
- Forced monaural function
- SNC (stereo noise controller)

- Stereo display pin
- Anti-birdie filter

AM

- Double balanced mixer
- IF amplifier
- Detection
- RF AGC (narrow/wide)
- Pin diode drive pin
- IF AGC
- Signal meter output (also used for FM)
- Local oscillator circuits (first and second)
- Local oscillator buffer output
- IF counter buffer output (also used by the FM IF)
- SD (IF counter buffer on level) adjustment pin
- SD output (active high) (also used for AM)
- Wide AGC
- Detection output frequency characteristics adjustment pin (low cut, high deemphasis)
- AM stereo buffer

MRC (multipath noise rejection circuit)

AM/FM switching output (linked to the FM V_{CC})

LA1776M

Operating Characteristics at Ta = 25°C, V_{CC} = 8.0V, with the specified test circuit and for standards other than Sanyo's for the FM IF input

Parameter	Symbol	Conditions	Ratings			unit
			min	typ	max	
[FM Characteristics] At the FM IF input						
Current drain	I _{CCO-AM}	No input, I9 + I40 + I46 + I54 + I59 + I60 + I61	78	93	112	mA
Demodulation output	V _{O-FM}	10.7 MHz, 100dBμ, 1 kHz, 100%mod, The pin 15 output	205	310	415	mVrms
Pin 31 demodulation output	V _{O-31}	10.7 MHz, 100dBμ, 1 kHz, 100%mod, The pin 31 output	190	295	380	mVrms
Channel balance	CB	The ratio between pins 15 and 16 at 10.7 MHz, 100 dBμ, 1 kHz	-1	0	+1	dB
Total harmonic distortion	THD-FM mono	10.7 MHz, 100 dBμ, 1 kHz, 100% mod, pin 15		0.3	1	%
Signal-to-noise ratio: IF	S/N-FM IF	10.7 MHz, 100 dBμ, 1 kHz, 100% mod, pin 15	68	76		dB
AM suppression ratio: IF	AMR IF	10.7 MHz, 100 dBμ, 1 kHz, f _m = 1 kHz, 30% AM, pin 15	55	68		dB
Muting attenuation	Att-1	10.7 MHz, 100 dBμ, 1 kHz. The pin 15 attenuation when V33 goes from 0 to 2 V	5	10	15	dB
	Att-2	10.7 MHz, 100 dBμ, 1 kHz. The pin 15 attenuation when V33 goes from 0 to 2 V*1	16	21	26	dB
	Att-3	10.7 MHz, 100 dBμ, 1 kHz. The pin 15 attenuation when V33 goes from 0 to 2 V*2	26	31	36	dB
Separation	Separation	10.7 MHz, 100 dBμ, L+R = 90%, pilot = 10%. The pin 15 output ratio	30	40		dB
Stereo on level	ST-ON	The pilot modulation such that V39 < 0.5 V	2.3	3.5	5.5	%
Stereo off level	ST-OFF	The pilot modulation such that V39 > 3.5 V	0.6	1.6		%
Main total harmonic distortion	THD-Main L	10.7 MHz, 100 dBμ, L+R = 90%, pilot = 10%. The pin 15 signal		0.3	1.2	%
Pilot cancellation	PCAN	10.7 MHz, 100 dBμ, pilot = 10%. The pin 15 signal/the pilot level leakage. DIN audio	20	30		dB
SNC output attenuation	AttSNC	10.7 MHz, 100 dBμ, L-R = 90%, pilot = 10%. V28 = 3 V → 0.6 V, pin 15	4	8	12	dB
HCC output attenuation	AttHCC-1	10.7 MHz, 100 dBμ, 10 kHz, L+R = 90%, pilot = 10%. V29 = 3 V → 0.6 V, pin 15	2	6	10	dB
	AttHCC-2	10.7 MHz, 100 dBμ, 10 kHz, L+R = 90%, pilot = 10%. V29 = 3 V → 0.1 V, pin 15	7	11	15	dB
Input limiting voltage	V _{i-lim}	100 dBμ, 10.7 MHz, 30% modulation. The IF input such that the input reference output goes down by 3 dB	35	42	49	dBμ
Muting sensitivity	V _{i-mute}	The IF input level (unmodulated) when V33 = 2 V	45	53	61	dBμ
SD sensitivity	SD-sen1 FM	The IF input level (unmodulated) (over 100 mV rms) such that the IF counter buffer output goes on	72	80	88	dBμ
	SD-sen2 FM	Unmodulated IF input such that the SD pin goes to the on state	72	80	80	dBμ
IF counter buffer output	V _{IFBUFF-FM}	10.7 MHz, 100 dBμ, unmodulated. The pin 23 output	150	230	300	mVrms
Signal meter output	V _{SM FM-1}	No input. The pin 24 DC output, unmodulated		0.1	0.3	V
	V _{SM FM-2}	60 dBμ. The pin 24 DC output, unmodulated	0.6	1.2	1.8	V
	V _{SM FM-3}	80 dBμ. The pin 24 DC output, unmodulated	2.0	2.7	3.5	V
	V _{SM FM-4}	110 dBμ. The pin 24 DC output, unmodulated	4.5	5.2	5.9	V
Muting bandwidth	BW-mute	100 dBμ. The bandwidth when V33 = 2 V, unmodulated	150	220	290	kHz
Mute drive output	V _{MUTE-0}	No input. The pin 33 DC output, unmodulated	1.8	2.5	3.3	V
	V _{MUTE-100}	100 dBμ, 0 dBμ. The pin 33 DC output, unmodulated	0	0.1	0.2	V
[FM FE Mixer Input]						
N-AGC on input	V _{N-AGC}	83 MHz, unmodulated. The input such that the pin 2 voltage is 2.0 V or below	83	90	97	dBμ
W-AGC on input	V _{WAGC}	83 MHz, unmodulated. The input such that the pin 2 voltage is 2.0 V or below. (When the keyed AGC is set to 4.0 V.)	98	104	110	dBμ
Conversion gain	A.V	83 MHz, 80 dBμ, unmodulated. The FE CF output	90	140	220	mVrms
Oscillator buffer output	V _{OSCBUFFFM}	No input	85	110	165	mVrms
[Multipath Rejection Circuit] MRC input (pin 27)						
MRC output	VMRC	V24 = 5 V	2.9	3.0	3.1	V
MRC operating level	MRC-ON	The pin 26 input level at f = 70 kHz such that pin 24 goes to 5 V and pin 27 goes to 2 V	35	55	70	mVrms

Continued on next page.

LA1776M

Continued from preceding page.

Parameter	Symbol	Conditions	Ratings			unit
			min	typ	max	
[AM Characteristics] AM ANT input						
Practical sensitivity	S/N-30	1 MHz, 30 dB μ , $f_m = 1$ kHz, 30% modulation, pin 15	20			dB
Detector output	V_{O-AM}	1 MHz, 74 dB μ , $f_m = 1$ kHz, 30% modulation, pin 15	140	210	280	mVrms
Pin 31 detector output	V_{O-AM31}	1 MHz, 74 dB μ , $f_m = 1$ kHz, 30% modulation, pin 31	130	190	260	mVrms
AGC F.O.M.	$V_{AGC-FOM}$	1 MHz, 74 dB μ , referenced to the output, the input amplitude such that the output falls by 10 dB. Pin 15	51	56	61	dB
Signal-to-noise ratio	S/N-AM	1 MHz, 74 dB μ , $f_m = 1$ kHz, 30% modulation	50	56		dB
Total harmonic distortion	THD-AM	1 MHz, 74 dB μ , $f_m = 1$ kHz, 80% modulation		0.3	1	%
Signal meter output	V_{SM} AM-1	No input	0.0	0.1	0.5	V
	V_{SM} AM-2	1 MHz, 130 dB μ , unmodulated	3.9	4.9	6.8	V
Oscillator buffer output	$V_{OSCBUFF}$ AM	No input, the pin 15 output	185	230		mVrms
Wide band AGC sensitivity	W-AGCsen1	1.4 MHz, the input when $V_{48} = 0.7$ V	89	95	101	dB μ
	W-AGCsen2	1.4 MHz, the input when $V_{48} = 0.7$ V (seek mode)	80	86	92	dB μ
SD sensitivity	SD-sen1 AM	1 MHz, the ANT input level such that the IF counter output turns on.	24	30	36	dB μ
	SD-sen2 AM	1 MHz, the ANT input level such that the SD pin goes to the on state.	24	30	36	dB μ
IF buffer output	$V_{IFBUFF-AM}$	1 MHz, 74 dB μ , unmodulated. The pin 23 output	180	220		mVrms

Note: These measurements must be made using the either the IC-51-0644-692 IC socket (manufactured by Yamaichi Electronics).

- * 1. When the resistor between pin 58 and ground is 200 k Ω .
- * 2. When the resistor between pin 58 and ground is 30 k Ω .

Package Dimensions

Unit:mm

3159A

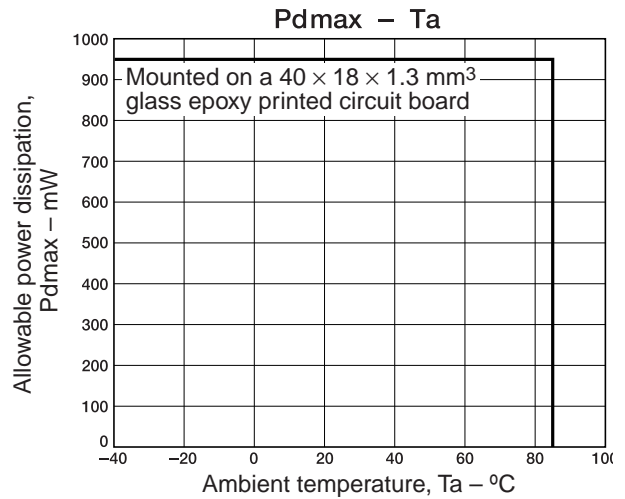
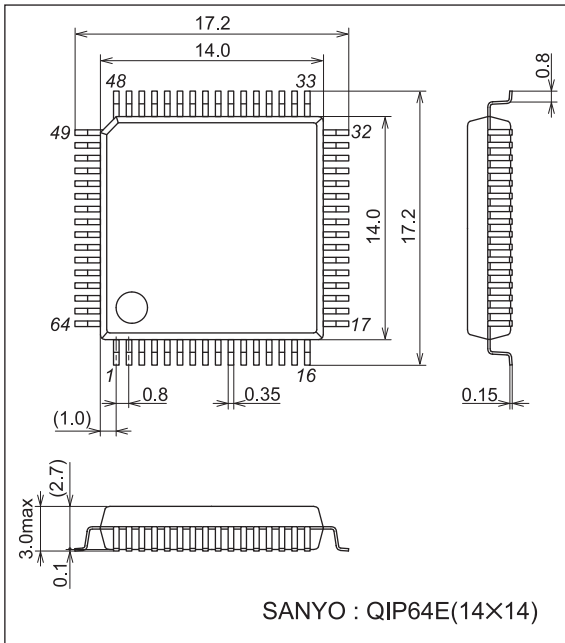

LA1776M AC Test Circuit

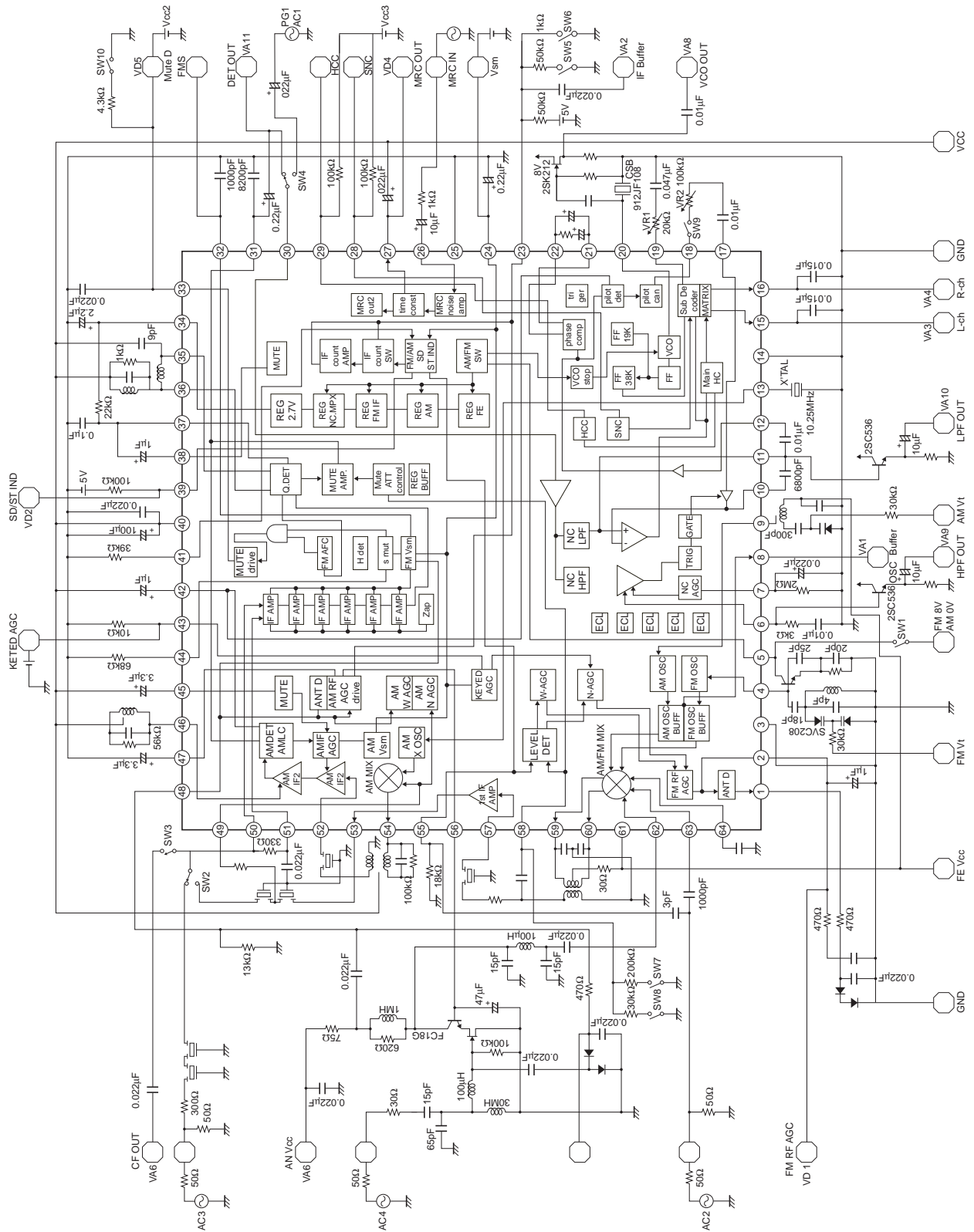

LA1776M

LA1776M Application Circuit Example

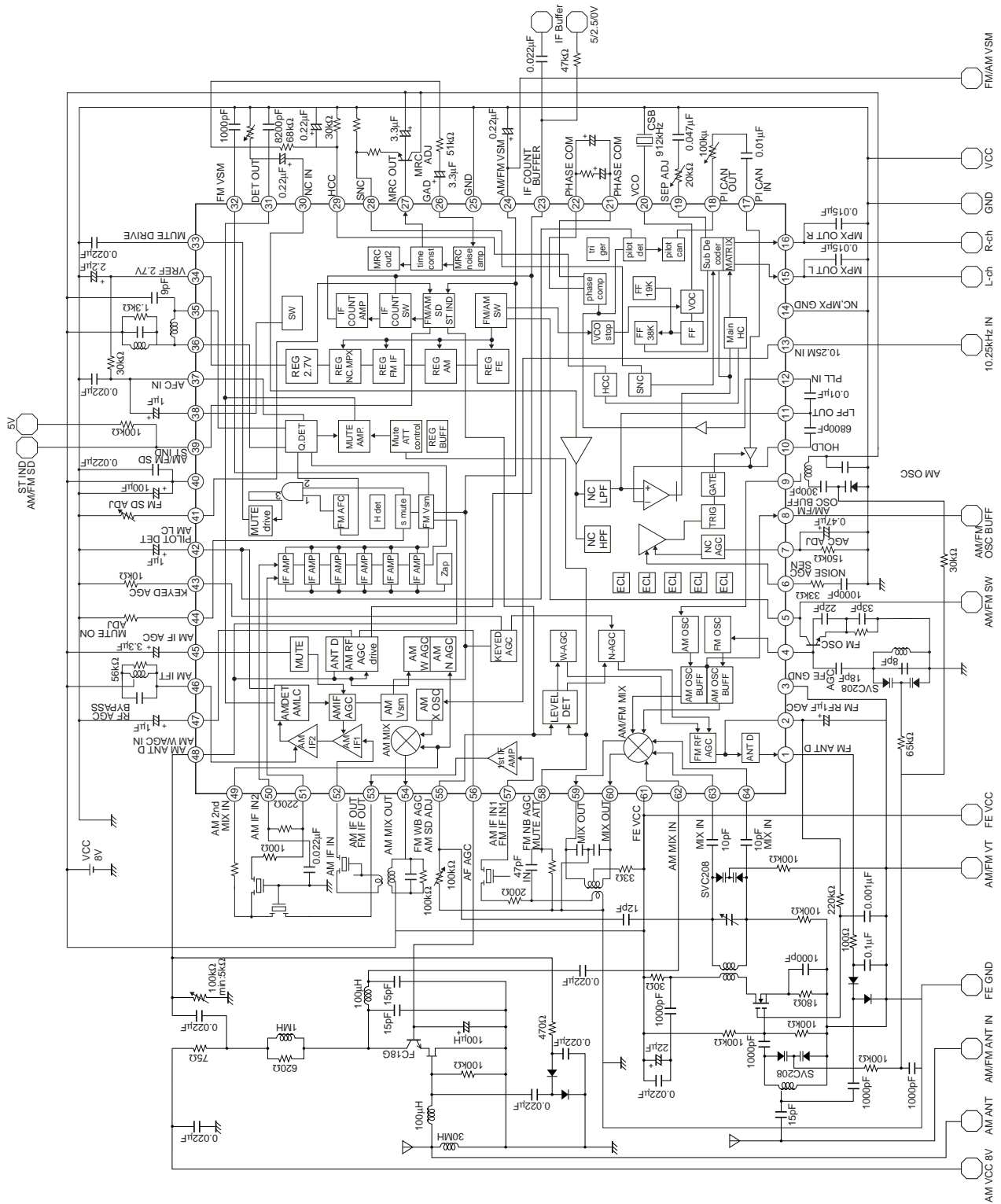

Pin Descriptions

Pin No.	Pin	Description	Equivalent circuit
1	FM antenna damping drive pin	An antenna damping current flows when the RF AGC voltage (pin 1) reaches $V_{CC} - V_D$.	
2	RF AGC	Used to control the FET second gate voltage. In AM mode, forcibly set the pin 2 voltage to the low level and apply AGC to the FM RF system.	
3	EF. GND		
4	FM OSC	Oscillator connection This pin is designed to drive an external oscillator circuit that uses external transistors and capacitors.	

Continued on next page.

LA1776M

Continued from preceding page.

Pin No.	Pin	Description	Equivalent circuit
5	AM/FM SW	<p>The pin 5 input voltage state (high or low) switches between AM and FM modes.</p> <p>V5 = high (8 V): FM</p> <p>V5 = low (0 V): AM</p> <p>This level is also used as the FM oscillator circuit V_{CC}.</p>	
6 7	Noise AGC sensitivity AGC adjustment	<p>After setting up the medium field (about 50 dBμ) sensitivity with the noise sensitivity setting pin (pin 6), set the weak field (about 20 to 30 dBμ) sensitivity with the AGC adjustment pin (pin 7)</p>	
8	AM/FM oscillator buffer output	<p>This pin is shared by the AM and FM systems.</p>	
9	AM OSC	<p>AM system first oscillator</p> <p>This oscillator can provide frequencies for use up to the shortwave band.</p> <p>This pin includes an ALC circuit.</p>	

Continued on next page.

LA1776M

Continued from preceding page.

Pin No.	Pin	Description	Equivalent circuit
10 11	Memory circuit connection	Recording circuit used during noise canceller operation.	
12	Pilot input	Pin 12 is the PLL circuit input pin.	
13	AM 2nd OSC	Crystal oscillator circuit Use the HC-49/U-S manufactured by Kinseki, Ltd. CL = 20 pF	
14	N. C, MPX, MRC, GND	Ground for the N, C, MPX, and MRC circuits	

Continued on next page.

LA1776M

Continued from preceding page.

Pin No.	Pin	Description	Equivalent circuit
15 16	MPX output (left) MPX output (right)	AM output FM multiplex output For deemphasis, use the following capacitors: 50 μ S: 0.015 μ F 75 μ S: 0.022 μ F	
17	Pilot canceller signal input	Adjustment is required since the pilot signal level varies with the sample-to-sample variations in the IF output level and other parameters.	
18	Pilot canceller signal output	Pin 18 is the output pin for the pilot canceller signal.	

Continued on next page.

LA1776M

Continued from preceding page.

Pin No.	Pin	Description	Equivalent circuit
19	Separation adjustment pin	Use a trimmer to adjust the subdecoder input level. (The output level is not modified in mono and main modes.)	
20	VCO	The oscillator frequency is 912 Hz. JF108	
21 22	PHASE COMP		

Continued on next page.

LA1776M

Continued from preceding page.

Pin No.	Pin	Description	Equivalent circuit
23	IF counter buffer seek/stop switching	<p>This pin functions both as the IF counter buffer (AC output) and as the seek/stop switch pin.</p> <p>FM mode 5 V (high): Seek mode 2.5 V: High-speed SD mode 0 V (low): Reception mode</p> <p>AM mode 5 V (high): Seek mode 0 V (low): Reception mode</p>	
24	AM/FM signal meter	Fixed-current drive signal meter output	
32	Dedicated FM signal meter		
26	MRC AC input	<p>The LA1776M supports two methods: detecting IF S-meter wideband components and detecting the noise canceller high-pass filter noise output.</p> <p>The noise amplifier gain is determined by R2 and the internal 30 kΩ resistor as shown in the figure. Note that the frequency characteristics are determined by C1.</p>	
27	MRC output	The MRC detector time constant is determined by a 100 Ω resistor and C2 when discharging and by the 7-μA current and C2 when charging.	

Continued on next page.

LA1776M

Continued from preceding page.

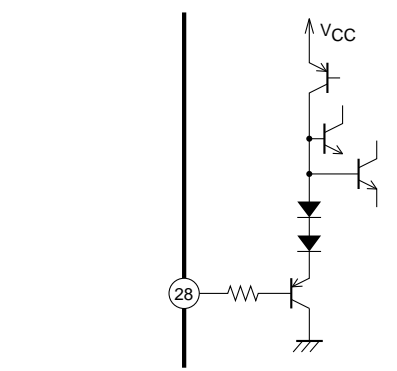
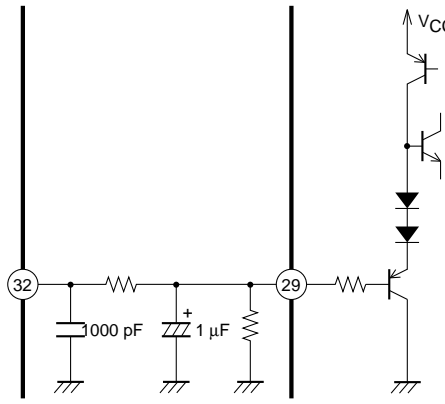
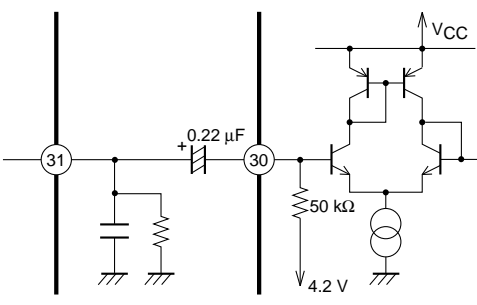
Pin No.	Pin	Description	Equivalent circuit
28	SNC control input	The sub-output is controlled by a 0 to 1-V input.	
29	HCC control input	The high-frequency output is controlled by an input in the 0 to 1 V range.	
30	Noise canceller input	The input impedance is about 50 kΩ.	

Continued on next page.

LA1776M

Continued from preceding page.

Pin No.	Pin	Description	Equivalent circuit
30 31	Noise canceller input AM/FM detector output	<p>Pin 30 is the noise canceller input. The input impedance is 50 kΩ</p> <p>Pin 31 is the AM and FM detector output In FM mode, this is a low-impedance output. In AM mode, the output impedance is 10 kΩ. The AM detection output can be modified by adjusting the value of R.</p>	
32	IF S-meter output	FM S-meter output block	
33	Mute drive output	<ul style="list-style-type: none"> The muting time constant is determined by an external RC circuit as described below. Attack time: $T_A = 10 \text{ k}\Omega \times C1$ Release time: $T_R = 50 \text{ k}\Omega \times C1$ Noise convergence adjustment The noise convergence when V33 is 2 V will be about 40 dB. (The basis can be varied from 5 to 35 dB for a 1 kHz 22.5 kHz deviation output.) *: There is no hole detection function. Muting off function The muting function is turned off by a 4 kΩ resistor between pin 33 and ground. 	

Continued on next page.

LA1776M

Continued from preceding page.

Pin No.	Pin	Description	Equivalent circuit
34 35 36	Vref: 2.7 V QD output	<p>Null voltage</p> <p>When tuned, the voltage between pins 34 and 37, V_{34-37}, will be 0 V.</p> <p>The band muting function turns on when $V_{34-37} \geq 0.7$ V.</p>	
38	Band muting time constant switching	<p>R1: Resistor that determines the width of the band muting function</p> <p>When R1 is larger ... The band becomes narrower</p> <p>When R1 is smaller ... The band becomes wider</p> <p>The band muting time constants are determined by the following components.</p> <p>During reception: R1, C34, and C38</p> <p>During seek: R1 and C34</p> <p>The band muting time constant can be made smaller by reducing the value of C34. Degradation of total harmonic distortion characteristics at low temperatures can be prevented by make C38 larger.</p>	
39	AM/FM SD pin Stereo indicator	<p>V23 is switched by the voltage mode as described below.</p> <p>FM mode</p> <p>5 V: V23 operates in conjunction with the SD pin and IF counter buffer.</p> <p>2.5 V: V23 operates as the forcible SD mode pin.</p> <p>0 V: Reception mode</p> <p>AM mode (There are two modes: 0 V or 5 V.)</p> <p>5 V: Linked operation with the seek SD pin.</p> <p>2.5 V: Reception mode, no function.</p> <p>0 V: Reception mode</p>	

Continued on next page.

LA1776M

Continued from preceding page.

Pin No.	Pin	Description	Equivalent circuit
40	VCC	IF, NC, MPX, VCC	
41	FM SD	<p>The comparison voltage is controlled by an external resistor.</p> <p>In seek mode, the seek operation will stop when $V_{41} < V_{sm}$.</p>	
42	Pilot detector AM L.C	<p>This pin is used for both FM pilot detection and AM low-cut filter.</p> <p>Pilot detection The system is forced to mono mode when a 1 MΩ resistor is inserted between pin 42 and ground. In AM mode, the frequency characteristics of the unneeded audio band below 100 Hz are modified producing a clear audio signal.</p> <p>AM low-cut filter The cutoff frequency f_C can be determined from the following formula. $f_C = 1/2 \pi \times 3.3 \text{ k}\Omega \times C$</p>	
43	Keyed AGC	<p>Dedicated keyed AGC S-meter</p> <p>The keyed AGC function starts operation when V_{43} becomes less than or equal to 0.8 V. (Narrow AGC off mode.)</p>	

Continued on next page.

LA1776M

Continued from preceding page.

Pin No.	Pin	Description	Equivalent circuit
44	FM muting on level adjust	Modify the value of the external resistor to adjust the muting on level.	
45	IF AGC	<p>TR1: Seek mode time constant switching diode Discharge diode</p> <ul style="list-style-type: none"> • Reception $\tau = 3.3 \mu\text{F} \times 300 \text{ k}\Omega$ • Seek $\tau = 3.3 \mu\text{F} \times 10 \Omega$ <p>The external capacitors are connected to V_{CC}. This is because the IF amplifier operates referenced to V_{CC}.</p>	
46	IF output	The IF amplifier load	

Continued on next page.

LA1776M

Continued from preceding page.

Pin No.	Pin	Description	Equivalent circuit
47 56	RF AGC bypass RF AGC	<p>RF AGC rectification capacitor</p> <p>The low frequency distortion is determined as follows:</p> <p>Increasing C47 and C56 improves the distortion but makes the response slower.</p> <p>Reducing C47 and C56 aggravates the distortion but makes the response faster.</p> <p>*:If the audio is disturbed due to the RF AGC when there are rapid changes in the reception field strength (on the order of off to 80 dBμ), the combination of the time constants due to C56 and C47 must be changed.</p>	
50 51	FM IF input IF bypass	<p>Due to the high gain of the limiter amplifier, care must be taken when choosing the grounding point for the limiter amplifier input capacitor to prevent oscillation.</p>	
52	IF input	<p>The input impedance is 2 kΩ.</p>	
53 57	IF amplifier output (AM/FM) IF amplifier input (AM/FM)	<ul style="list-style-type: none"> • First IF amplifier input pin • Inverted output amplifier <p>The gain is switched between AM and FM modes</p>	

Continued on next page.

LA1776M

Continued from preceding page.

Pin No.	Pin	Description	Equivalent circuit
54 49	AM MIX OUT AM MIX IN	<p>The mixer coil connected to the pin 54 mixer output must be wired to V_{CC} (pin 40).</p> <p>The pin 49 mixer input impedance is 10 Ω</p>	
58	W-AGC IN AM-SD Adj N-AGC IN	<p>Pins 55 and 58 include built-in DC cut capacitors.</p> <p>The AGC on level is determined by the values of the capacitors C1 and C2.</p> <p>Pin 55 functions as the SD sensitivity adjustment pin in AM mode.</p> <p>V55 is changed by the value of the external resistor.</p> <p>SD is operated by comparing V55 with the S-meter voltage.</p> <p>Seek mode stop condition: $V_{55} < V_{sm}$</p>	
48	AM antenna damping drive output Wideband AGC input FM S-meter voltage shift	<p>$I_{48} = 6 \text{ mA}$</p> <p>Antenna damping current</p> <p>Resistor values under 5 kΩ cannot be used for the FM S-meter shift resistor.</p>	

Continued on next page.

LA1776M

Continued from preceding page.

Pin No.	Pin	Description	Equivalent circuit
59 60 62	FM/AM MIX output AM MIX input	<p>Y-type mixer circuit</p> <p>Pins 59 and 60 are the mixer outputs</p> <p>10.7 MHz (10.71 MHz)</p> <p>Input impedance: 10 kΩ</p> <p>V62 = 2.3 V</p>	
59 60 63 64	Mixer output Mixer input	<p>Double balanced mixer</p> <p>Pins 59 and 60 are the mixer 10.7-MHz output</p> <p>Pins 63 and 64 are the mixer inputs</p> <p>These are base injection type inputs.</p> <p>Note: The lines for pins 63 and 64 must be kept separated from the lines for pins 59 and 60.</p>	

LA1776M

Test Conditions

Parameter	Symbol	SW1	SW2	SW3	SW4	SW5	SW6	SW7	SW8	SW9	SW10
Current drain	I _{CCO-AM}	OFF	B	OFF	B	—	ON	OFF	OFF	ON	—
Demodulation output	V _{O-FM}	ON	B	OFF	B	—	ON	OFF	OFF	ON	—
Pin 31 demodulation output	V _{O-31}	ON	B	OFF	B	—	ON	OFF	OFF	ON	—
Channel balance	CB	ON	B	OFF	B	—	ON	OFF	OFF	ON	—
Total harmonic distortion (FM)	THD-FM mono	ON	B	OFF	B	—	ON	OFF	OFF	ON	—
Signal-to-noise ratio: IF	S/N-FM IF	ON	B	OFF	B	—	ON	OFF	OFF	ON	—
AM suppression ratio: IF	AMR IF	ON	B	OFF	B	—	ON	OFF	OFF	ON	—
Muting attenuation	Att-1	ON	B	OFF	B	—	ON	OFF	OFF	ON	—
	Att-2	ON	B	OFF	B	—	ON	ON	OFF	ON	—
	Att-3	ON	B	OFF	B	—	ON	OFF	ON	ON	—
Separation	Separation	ON	B	OFF	B	—	ON	OFF	OFF	ON	—
Stereo on level	ST-ON	ON	B	OFF	B	—	ON	OFF	OFF	ON	—
Stereo off level	ST-OFF	ON	B	OFF	B	—	ON	OFF	OFF	ON	—
Main total harmonic distortion	THD-Main L	ON	B	OFF	B	—	ON	OFF	OFF	ON	—
Pilot cancellation	PCAN	ON	B	OFF	B	—	ON	OFF	OFF	OFF/ON	—
SNC output attenuation	AttSNC	ON	B	OFF	B	—	ON	OFF	OFF	ON	—
HCC output attenuation 1	AttHCC-1	ON	B	OFF	B	—	ON	OFF	OFF	ON	—
HCC output attenuation 2	AttHCC-2	ON	B	OFF	B	—	ON	OFF	OFF	ON	—
Input limiting voltage	V _{IN-LIM}	ON	B	OFF	B	—	ON	OFF	OFF	ON	ON
Muting sensitivity	V _{IN-MUTE}	ON	B	OFF	B	—	ON	OFF	OFF	ON	—
SD sensitivity 1	SD-sen1 FM	ON	B	OFF	B	OFF	OFF	OFF	OFF	ON	—
SD sensitivity 2	SD-sen2 FM	ON	B	OFF	B	ON	OFF	OFF	OFF	ON	—
IF counter Buffer output	V _{IFBUFF-FM}	ON	B	OFF	B	OFF	OFF	OFF	OFF	ON	—
Signal meter output (FM)	V _{SM FM-1}	ON	B	OFF	B	—	ON	OFF	OFF	ON	—
	V _{SM FM-2}	ON	B	OFF	B	—	ON	OFF	OFF	ON	—
	V _{SM FM-3}	ON	B	OFF	B	—	ON	OFF	OFF	ON	—
	V _{SM FM-4}	ON	B	OFF	B	—	ON	OFF	OFF	ON	—
Muting Bandwidth	BW-mute	ON	B	OFF	B	—	ON	OFF	OFF	ON	—
Mute drive output	V _{MUTE-0}	ON	B	OFF	B	—	ON	OFF	OFF	ON	—
	V _{MUTE-100}	ON	B	OFF	B	—	ON	OFF	OFF	ON	—
N-AGC on input	V _{NAGC}	ON	A	ON	B	—	ON	OFF	OFF	—	—
W-AGC on input	V _{WAGC}	ON	A	ON	B	—	ON	OFF	OFF	—	—
Conversion gain	A.V	ON	A	ON	B	—	ON	OFF	OFF	—	—
Oscillator buffer output	V _{OscBUFF-FM}	ON	A	ON	B	—	ON	OFF	OFF	—	—
MRC output	V _{MRC}	ON	—	OFF	B	—	ON	OFF	OFF	—	—
MRC operating level	MRC-ON	ON	—	OFF	B	—	ON	OFF	OFF	—	—
Practical sensitivity	S/N-30	OFF	—	OFF	B	ON	ON	—	—	—	—
Detection output	V _{O-AM}	OFF	—	OFF	B	ON	ON	—	—	—	—
Pin 31 detection output	V _{O-AM31}	OFF	—	OFF	B	ON	ON	—	—	—	—
AGC F.O.M.	V _{AGC-FOM}	OFF	—	OFF	B	ON	ON	—	—	—	—
Signal-to-noise ratio	S/N-AM	OFF	—	OFF	B	ON	ON	—	—	—	—
Total harmonic distortion (AM)	THD-AM	OFF	—	OFF	B	ON	ON	—	—	—	—
Signal meter output (AM)	V _{SM AM-1}	OFF	—	OFF	B	ON	ON	—	—	—	—
	V _{SM AM-2}	OFF	—	OFF	B	ON	ON	—	—	—	—
Oscillator buffer output	V _{OscBUFF-AM}	OFF	—	OFF	B	ON	ON	—	—	—	—
Wide band AGC sensitivity	W-AGCsen 1	OFF	—	OFF	B	ON	ON	—	—	—	—
	W-AGCsen 2	OFF	—	OFF	B	ON	ON	—	—	—	—
SD sensitivity	SD-sen1 AM	OFF	—	OFF	B	OFF	OFF	—	—	—	—
	SD-sen2 AM	OFF	—	OFF	B	OFF	OFF	—	—	—	—
IF buffer output	V _{IFBUFF-AM}	OFF	—	OFF	B	OFF	OFF	—	—	—	—

Usage Notes

1. AM/FM Switching

Pin 5 is used for switching between AM and FM (dedicated FM oscillator V_{CC})

FM mode: When the pin 5 voltage is greater than 4 V.

AM mode: When the pin 5 voltage is less than 4 V.

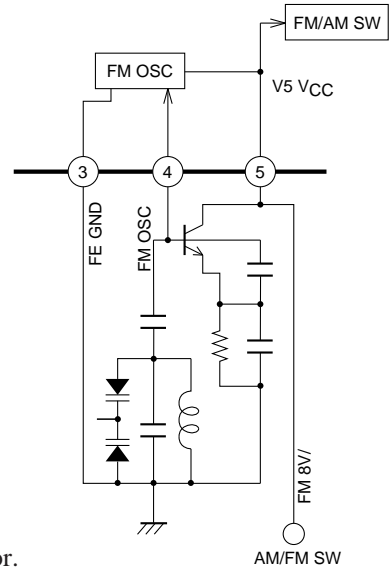

2. Pin 39: AM/FM SD and Stereo Indicator

Pin 39 is used both for AM and FM station detection and as a stereo indicator.

FM mode

5 V: Operates as the SD pin, coupled to the IF counter buffer.

2.5 V: Operates in forced SD mode.

0 V: Reception mode

AM mode (two modes: 0 V and 5 V)

5 V: Operates coupled as the seek SD pin

2.5 V: Reception mode, no function

0 V: Reception mode

3. Front End

Notes on interface characteristics

Like the previous Sanyo products, the LA1776M includes the 3 D (triple dimension) AGC circuit. This circuit allow the LA1776M to achieve at the same time both good three-signal interference characteristics (intermodulation characteristics) and two-signal sensitivity suppression characteristics.

3-1. Intermodulation characteristics

The LA1776M prevents intermodulation from occurring by applying dual high-band AGC.

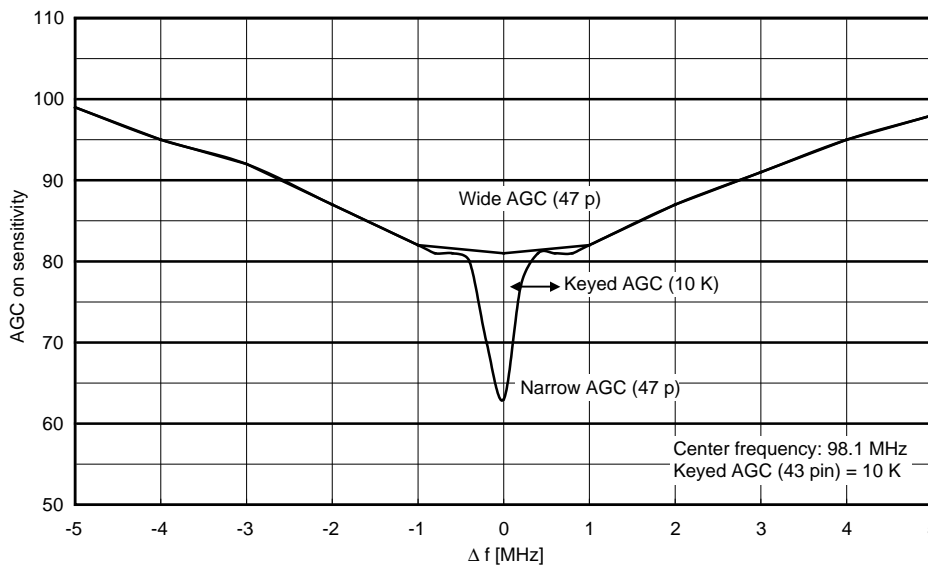

LA1776M

3-2. Two-Signal Sensitivity Suppression

Like the earlier Sanyo products, the LA1776M's 3D AGC determines the amount of wide-band AGC applied using the information acquired from three frequency characteristics.

RF and antenna circuit information: Mixer input AGC

Mixer circuit information: Mixer output AGC <- Three dimensions

CF selectivity: S-meter output

3-3. FE Block AGC

Like the earlier Sanyo products, the LA1776M uses the follow two functions

(1) PIN diode antenna input control

(2) FET second gate control

The AGC input pins are pin 58 (narrow AGC) and pin 55 (wide AGC).

Applying AGC

The PIN diode drive circuit is turned on when (roughly) $(V_{CC} - V_2)$ is 1 V or higher.

In application circuits, there will be about 30 to 40 dB of attenuation. When an adequate current flows in the antenna attenuator PIN diode and the impedance falls, the FET second gate voltage falls, the FET gm falls, and the AGC operates. The recommended FET is the Sanyo 3SK263, which is an enhanced type MOSFET, and thus the full AGC will be applied when the voltage between the second gate and the source (G_{2-S}) is 0. Note that if a depletion type MOSFET were used, AGC would not be applied unless $V_{G_{2-S}}$ were lower than 0 V.

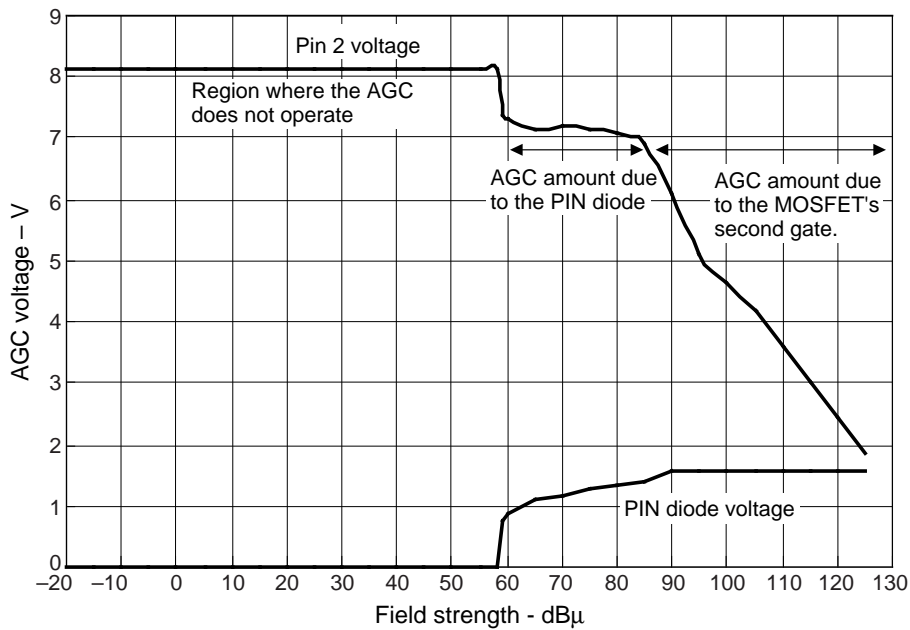

3-4. Mixer

The LA1776M's mixer circuit is a double balanced mixer that used balanced signals for both the input and output.

Input type: base input

Input impedance: 2 kΩ

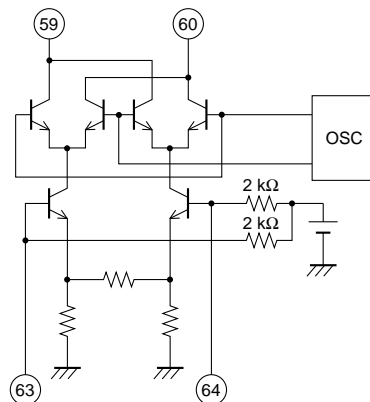

3-5. Mixer

Pin 4: The FM oscillator circuit is formed from external components.

Pin 8: AM/FM oscillator buffer

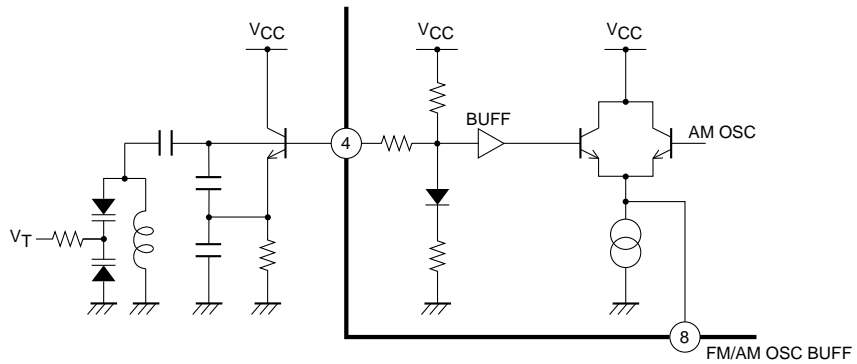

3-6. FM: First IF Amplifier (10.7 MHz)

Input impedance: 330 Ω (pin 57)

Output impedance: 330 Ω (pin 53)

4. FM IF

4-1. Notes on FM SD and SD Adjustment

The FM station detection and IF counter buffer operate with the following elements.

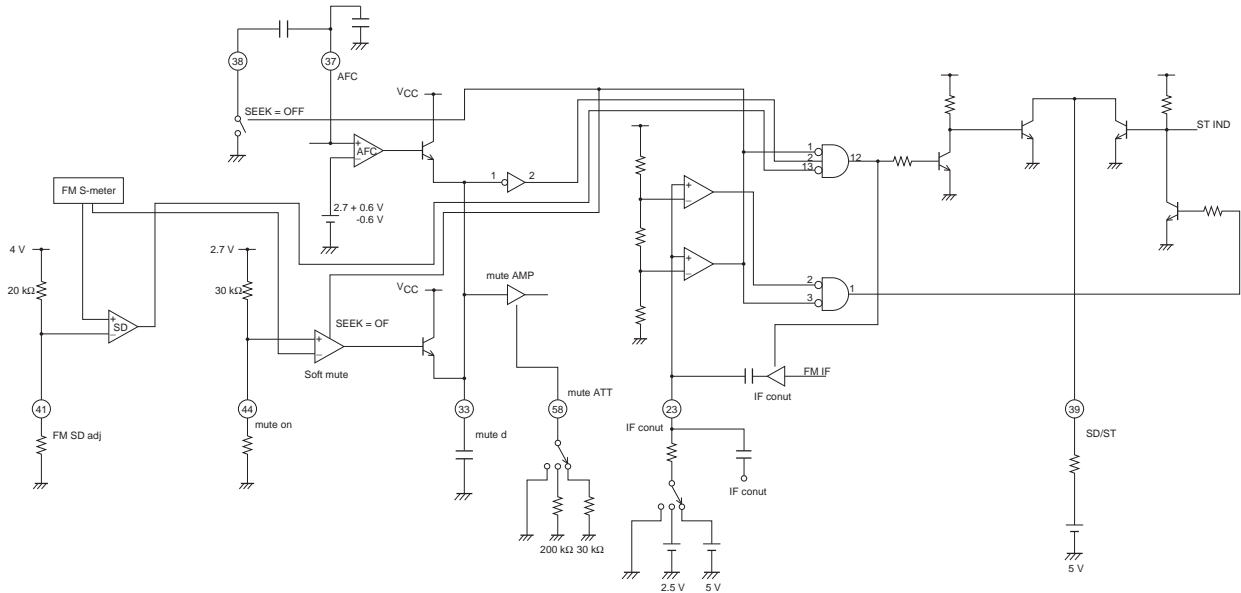

The following conditions must be met for the station detection and IF counter buffer to operate.

- (1) $V_{24} > V_{41}$ - The S-meter voltage must be higher than the pin 41 voltage
- (2) $V_{33} < 0.7 \text{ V}$ (V_{be}) - The band muting function must not be operating.
- (3) $V_{23} = \text{high}$ - A high level (V_{DD}) must be applied to pin 23 from a 51 k Ω resistor.

The figure below shows the relationships between the FM station detection, the IF counter buffer output, the S-meter voltage, and the muting operation output.

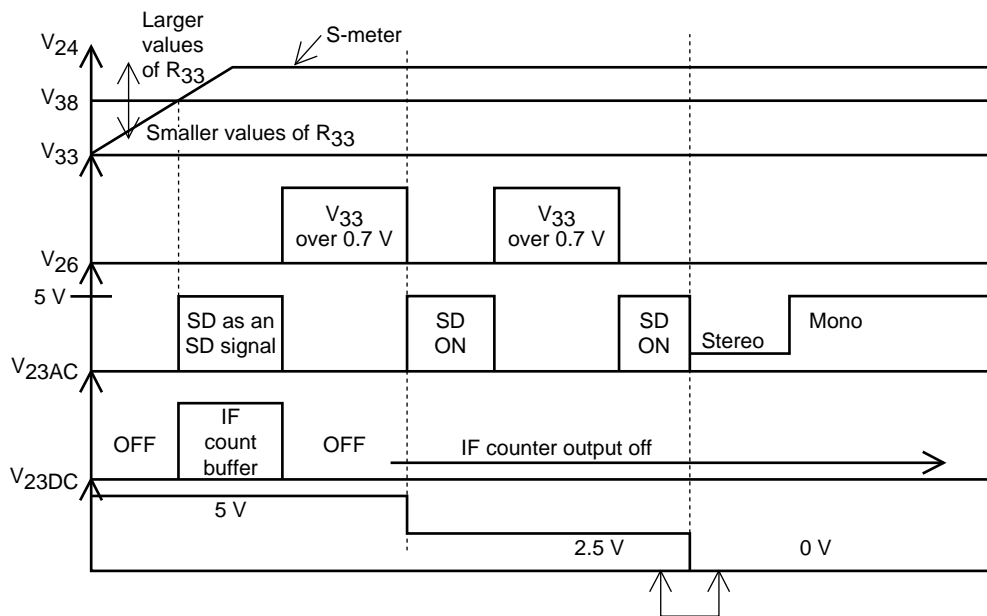

RDS and other types of SD detection can be used by switching these modes.

4-2. Transient Response Characteristics During Automatic Selection

The transient response characteristics when the SD or IF counter buffer are turned on or off are determined by the time constant at the pins shown below.

- (1) AFC time constant – Pin 37
- (2) Muting time constant – Pin 33
- (3) S-meter time constant – Pin 24

(1) Station detection time constant due to the pin 37 AFC voltage time constant

Since there is a function for switching the AFC time constant, it is possible to set the time constants so that there are no harmful effects. For reception mode, if the pin 38 capacitor value is not made comparatively large, the total harmonic distortion may be made worse.

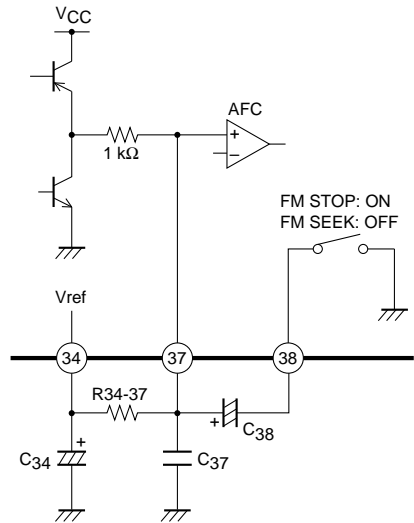

- Reception mode time constant: Make the time constant longer with R34_37, C37, and C38.

- Seek mode time constant: A high-speed response can be achieved with R34_37 and C37, since the seek mode time constant is independent of C38.

- The following values are recommended.

- C37: About 0.022 μ F
- C38: About 1 μ F

(2) Station detection time constant due to the pin 33 muting voltage time constant

The volume changes due to fluctuations in the field during weak field reception can be made smoother by setting the soft muting operation attack and release times appropriately.

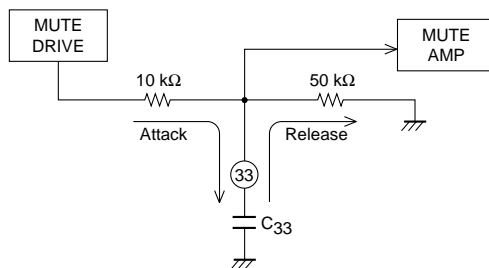

(3) Station detection time constant due to S-meter time constant

Since the pin 24 current (I24) changes with the field strength, the time constant also changes. There is no hysteresis in the comparator circuit. Note that if a smaller value is used for C24, the MRF frequency characteristics setting will need to be changed as well.

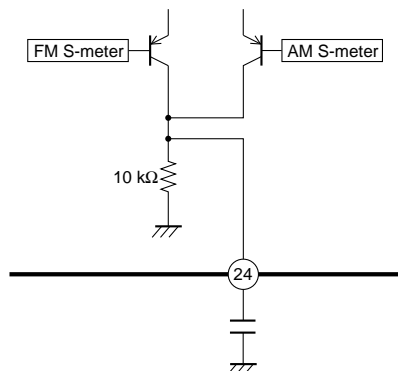

LA1776M

4-3. FM Muting Function Control (pin 44: soft muting) and Attenuation Setting (pin 58)

The -3 dB limiting sensitivity can be adjusted by changing the value of R44.

The muting attenuation can be switched between three levels (-10, -20, and -30 dB) with R58.

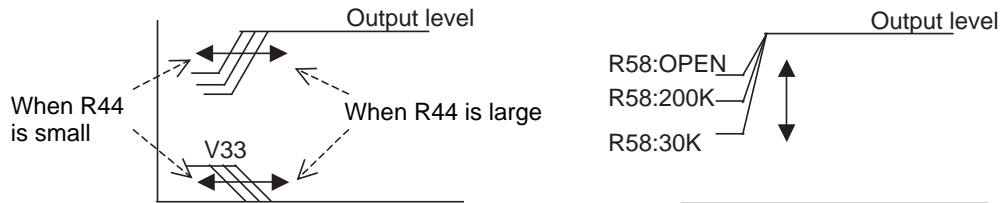

R58	Mute ATT
OPEN	-10 dB
200 K	-20 dB
30 K	-30 dB

5. AM Block

The LA1776M adopts an upconversion method.

5-1. AM AGC System

The RF AGC pickup operates according to the input level on pins 48 and 49.

Pin 48: AGC based on the components in the 10.7 MHz CF band.

Pin 49: Wideband AGC (The level at which the wideband AGC turns on can be adjusted with R_w .)

(The seek mode wideband AGC on level is increased by 10 dB.)

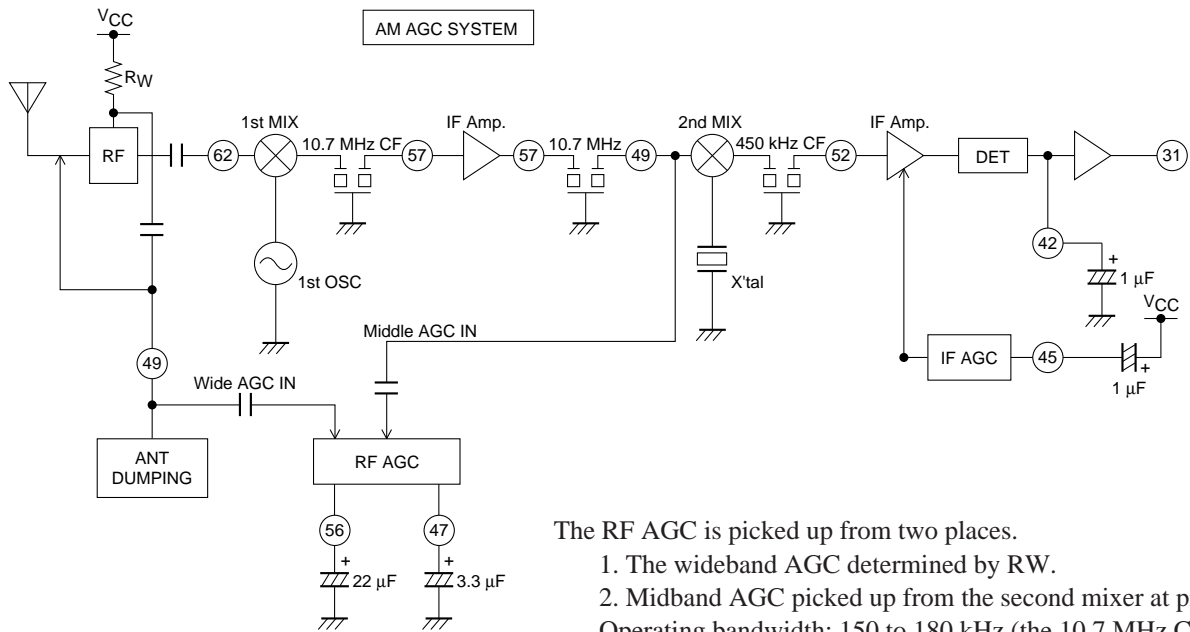

The RF AGC is picked up from two places.

1. The wideband AGC determined by R_w .
 2. Midband AGC picked up from the second mixer at pin 49.
- Operating bandwidth: 150 to 180 kHz (the 10.7 MHz CF bandwidth)

LA1776M

5-2. AM SD Pin (pin 39) and the AM SD Adjustment Pin

The LA1776M compares V24 and the reference voltage V55 to operate SD and the IF counter.

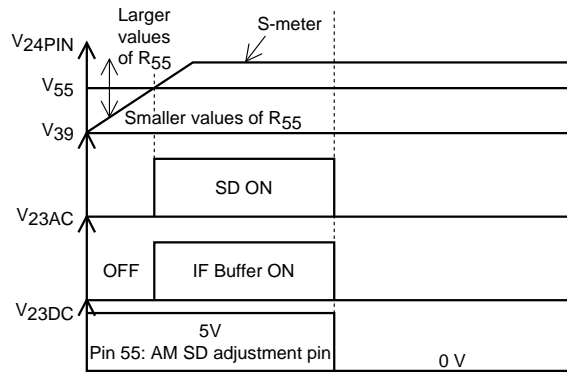
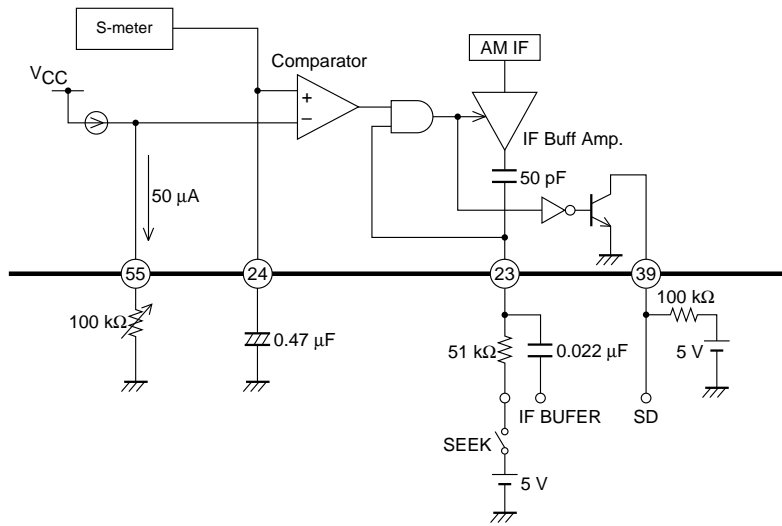

5-3. AM Wideband Cut and Detection Output Adjustment Methods

The AM/FM detection output (pin 31) has an output impedance of 10 kΩ in AM mode, and an impedance of a few tens of ohms in FM mode. Therefore the AM detection output level is lowered by R31 and the AM wideband frequency characteristics are determined by C31.

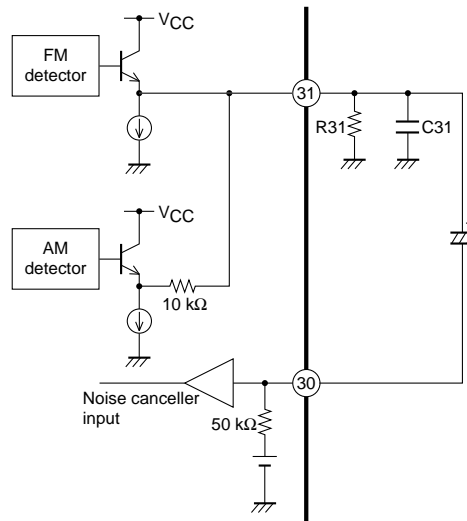

5-4. AM Low Region Cut Adjustment

The AM low frequency region frequency characteristics can be adjusted with capacitor C42, which is inserted between pin 42 and ground. Since this capacitor is shared with the FM pilot detector, it is connected to ground. To prevent incorrect operation of the pilot detector, C42 must have a value of 0.33 μ F or higher.

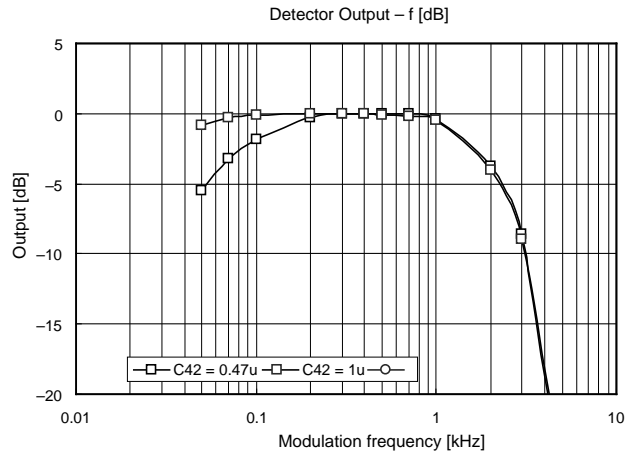
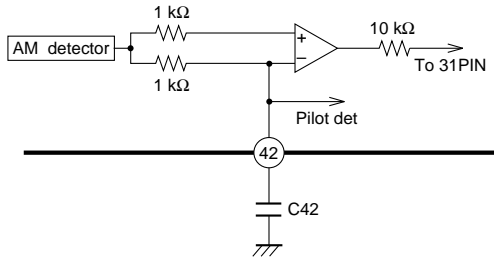

6. Noise Canceller Block

6-1. The noise canceller input (pin 30) has an input impedance of about 50 k Ω . The low band frequency characteristics require care when determining the value for the coupling capacitor. Note that f_c will be about 3 Hz in an application that uses a 1 μ F capacitor.

6-2. The noise detection sensitivity and the noise AGC are set with pins 8 and 9. Good settings can be acquired by first setting the medium field strength (corresponding to an antenna input of about 50 dB μ) sensitivity with the noise sensitivity setting pin (pin 8) and then setting the weak field (20 to 30 dB μ) with the AGC adjustment pin (pin 9). Note that if the noise detection sensitivity is increased, the effect of the AGC will be improved, but that inversely the weak field sensitivity will be decreased.

The problem of incorrect operation of the noise canceller for 10 kHz overmodulation occurs when an overmodulated signal is input and the noise canceller responds to that signal even though it should not. The cause of this is the IF detector output taking on the sort of waveform shown in the figure due to the band of the IF ceramic filter as shown below. (150 kHz \times 1, 180 kHz (r) 2, $f = 10$ kHz, 180 kHz deviation) The noise canceller responds to the whisker components generated by this overmodulation, resulting in distortion of the audio output. (The whisker components due to the overmodulation are generated by the band of the ceramic filter in the tuner.) This can be prevented as follows. The incorrect operation due to the overmodulation can be eliminated by removing the whisker components due to the overmodulation as described above with the low-pass filter consisting of a 1 k Ω resistor and 220 pF capacitor as shown in the figure. Note, however, that the FM separation characteristics in the high band and the AM frequency characteristics will change.

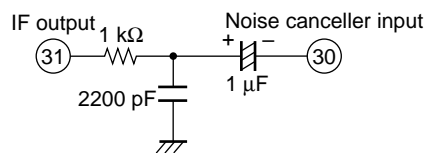
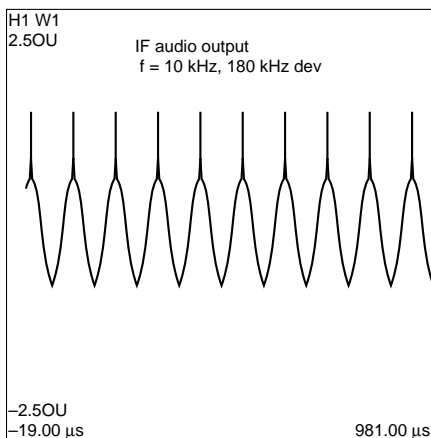

7. Multiplex Block
7-1. Pilot Cancellor

The pin 18 pilot canceller signal waveform is a 19 kHz signal in which the third harmonic is not present. Since this signal has the same phase as the pilot signal, no capacitor is required between pin 18 and ground. Since the third harmonic is not present, excellent pilot cancellation in both the left and right channels can be acquired by adjusting the circuit with a variable resistor.

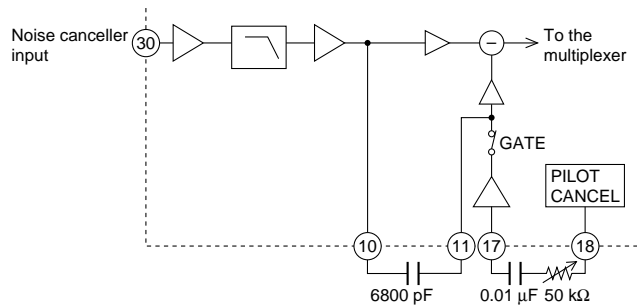

7-2. Separation Adjustment (pin 19)

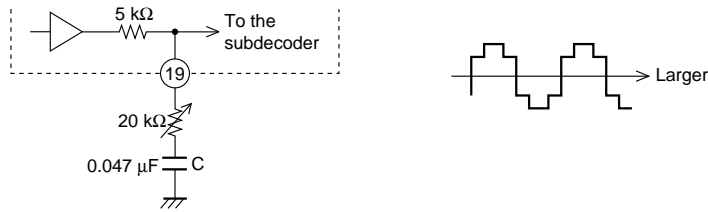

The separation is adjusted by adjusting the sub-decoder input level with the pin 19 variable resistor VR. Adjusting VR only changes the sub-channel modulation. It does not change the monaural (main) output level. Degradation of high band separation in the decoder can be avoided if the impedance of the external capacitor value (C) is made enough smaller than the impedance of VR in the sub-channel signal frequency band (23 to 53 kHz).

8. MRC Block

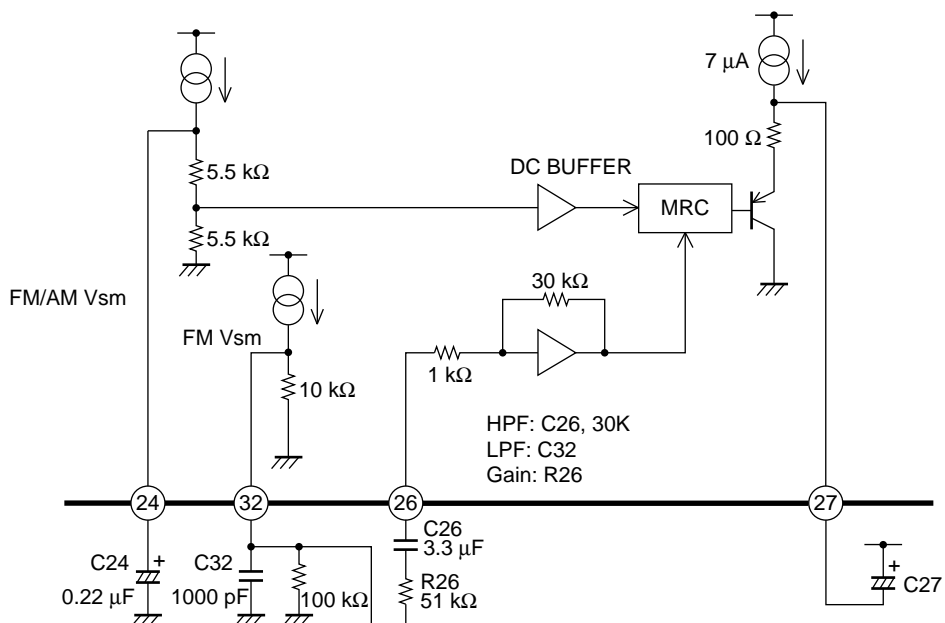

*: When the AC component is removed with C24.

8-1. The S-meter DC input voltage is set by the variable resistor R1 connected to pin 32. While it is often said that a curve such as that shown in figure 59 is ideal for separation control when multipath interference occurs, if the pin 32 voltage is too high, separation control in strong field reception, as shown in figure 60, will become impossible. Thus it is desirable to adjust the circuit so that the pin 32 voltage remains under 2 V when saturated.

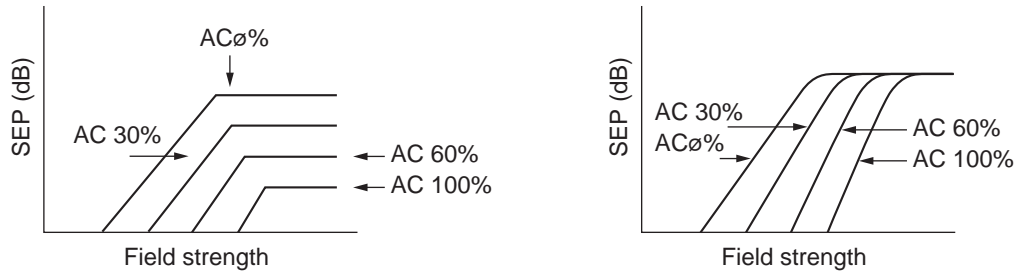

8-2. The time constant with which the MRC circuit controls the separation is determined by an internal $100\ \Omega$ resistor and C2 during charge and by a constant current of $7\ \mu\text{A}$ and C2 during discharge.

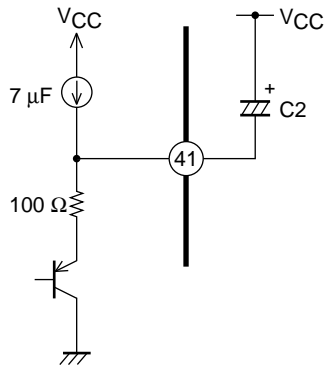

Crystal Oscillator Element

Kinseki, Ltd.

Frequency: 10.26 MHz

CL: 20 pF

Model No.: HC-49/U-S

Coil Specifications

Sumida Electronics, Ltd.

[AM Block]

AM FILTER (SA-1051)

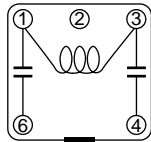

AM OSC (SA-359)

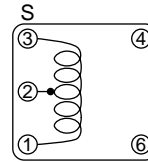

AM IF1 (SA-264)

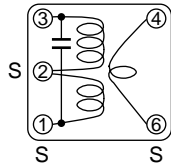

AM IF2 (SA-1063)

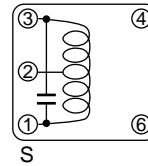

AM loading (SA-1062)

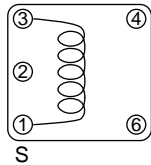

AM ANT IN (SA-1048)

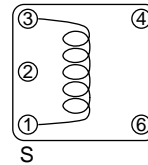

AM RF amplifier (RC875-222J)

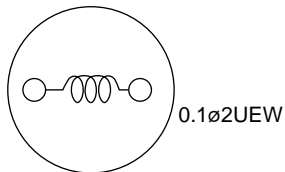

[FM Block]

FM RF (SA-1060)

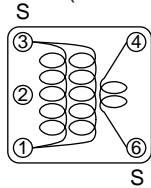

FM ANT (SA-1061)

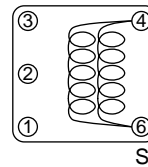

FM OSC (SA-1052)

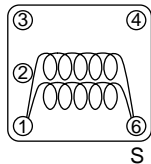

FM MIX (SA-266)

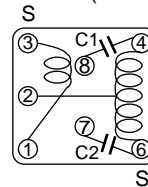

FM DET (SA-208)

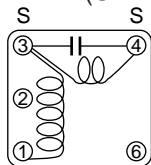

The Toko Electric Corporation

[AM Block]

AM FILTER (A2861BIS-15327)

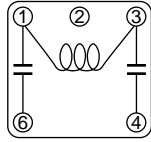

AM OSC (V666SNS-214BY)

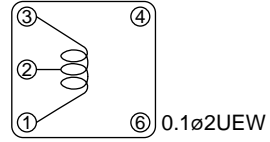

AM IF1 (7PSGTC-5001A)

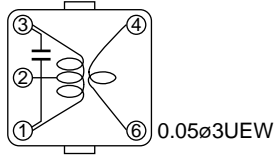

AM IF2 (7PSGTC-5002Y)

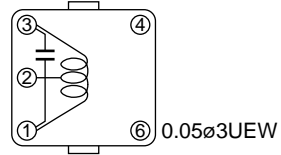

AM loading (269ANS-0720Z)

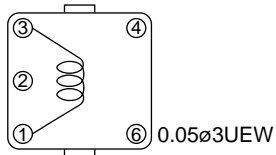

AM ANT IN (385BNS-027Z)

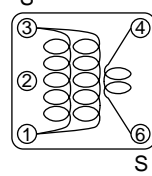

AM RF amplifier (187LY-222)

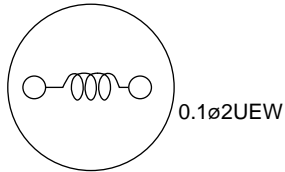

[FM Block]

FM RF (V666SNS-208AQ)

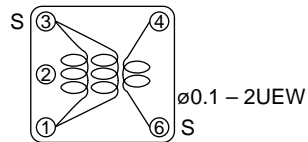

FM ANT (V666SNS-209BS)

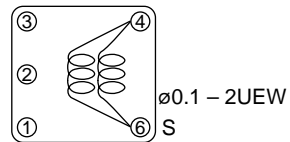

FM OSC (V666SNS-205APZ)

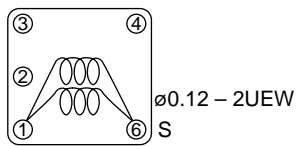

FM MIX (371DH-1108FYH)

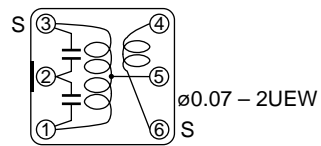

FM DET (DM600DEAS-8407GLF)

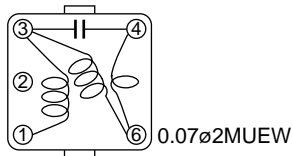

LA1776M

Sagami Elec Co., Ltd.

[AM Block]

AM FILTER (000021055)

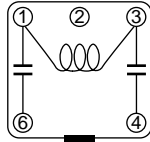

AM OSC (000021056)

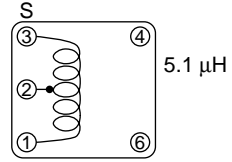

AM IF1 (000021057)

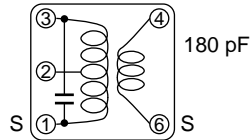

AM IF2 (000021059)

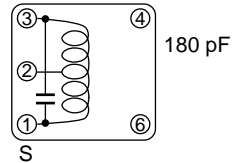

AM loading (000021061)

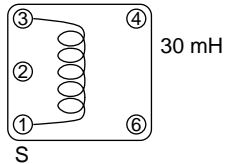

AM ANT IN (000021062)

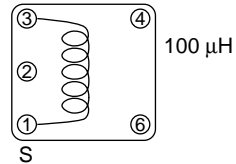

AM RF amplifier (000021063)

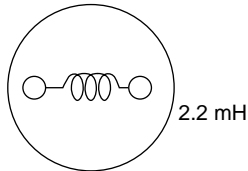

[FM Block]

FM RF (000021064)

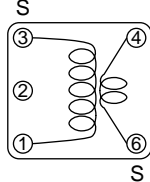

FM ANT (000021065)

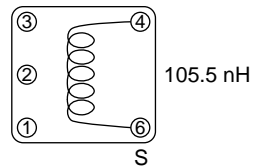

FM OSC (000021066)

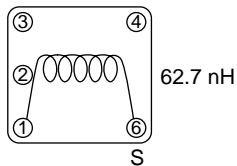

FM MIX (000021067)

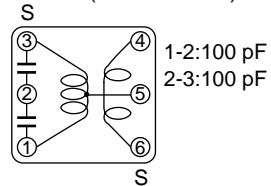

FM DET (010021075)

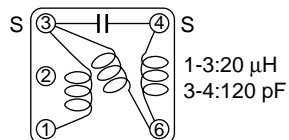

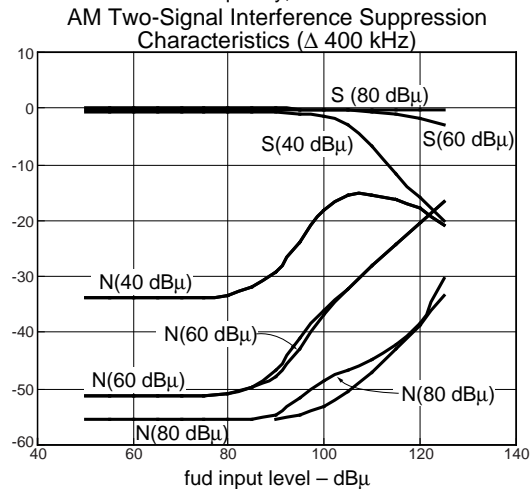
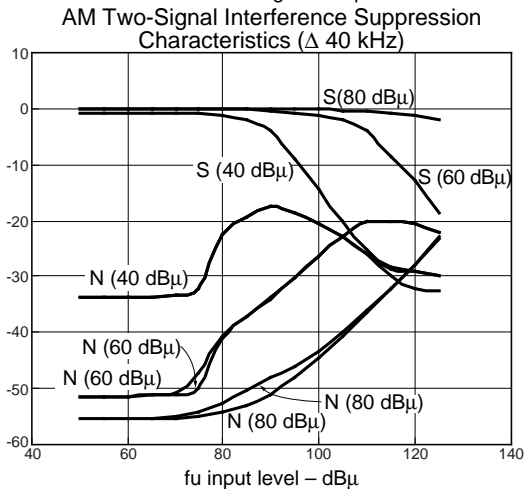
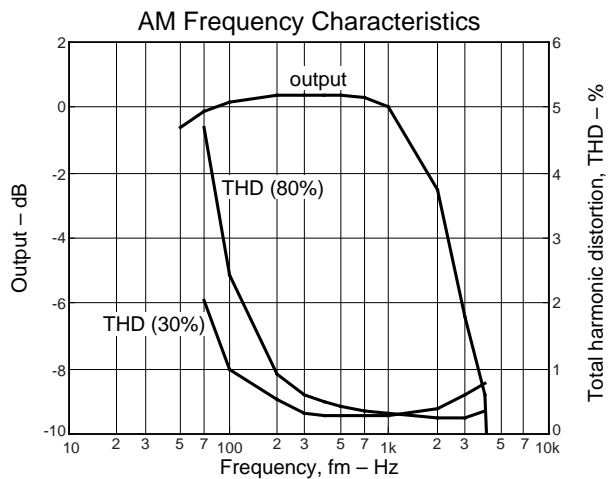
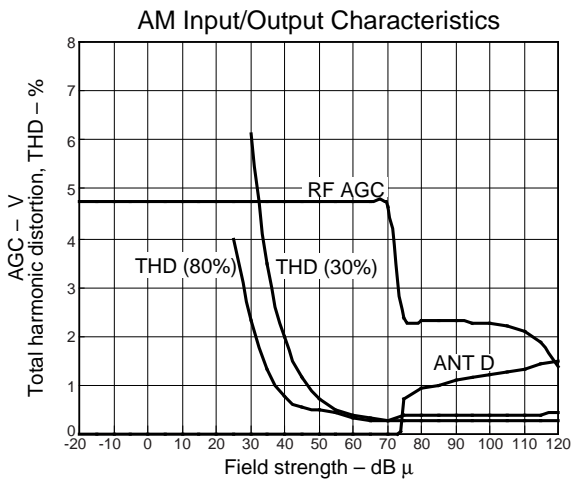
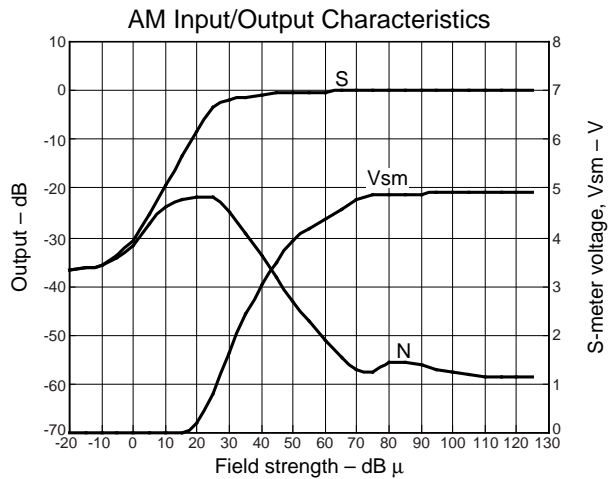
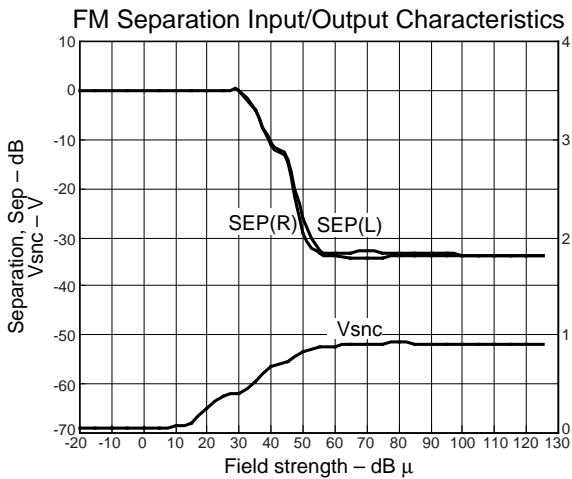
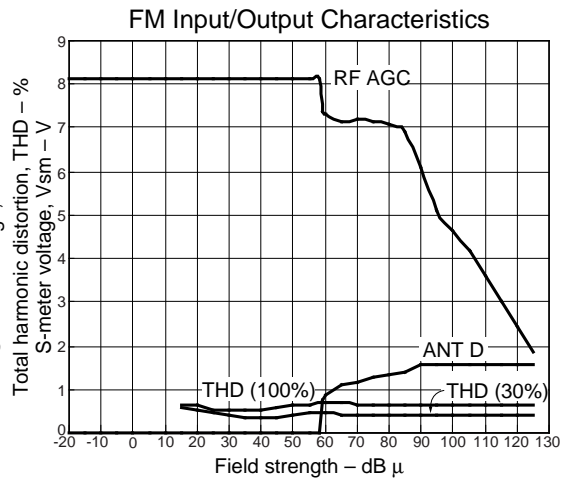
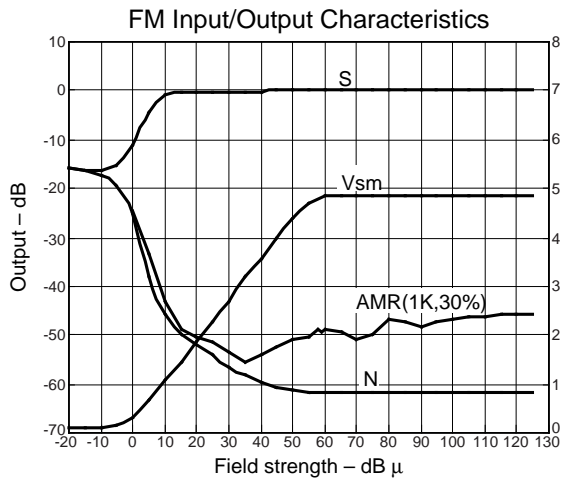

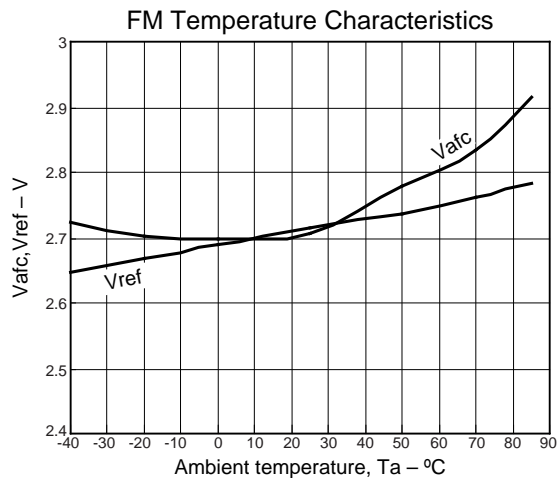
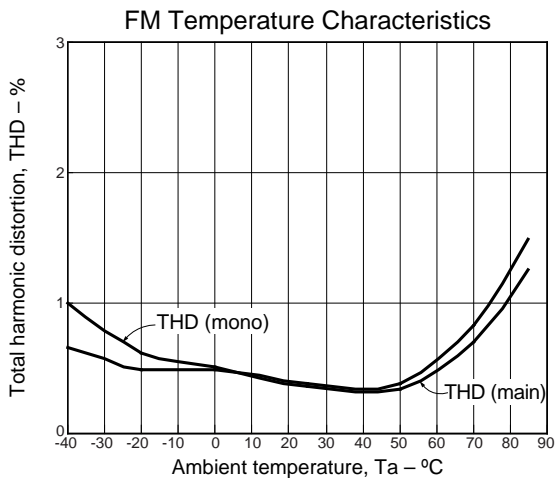
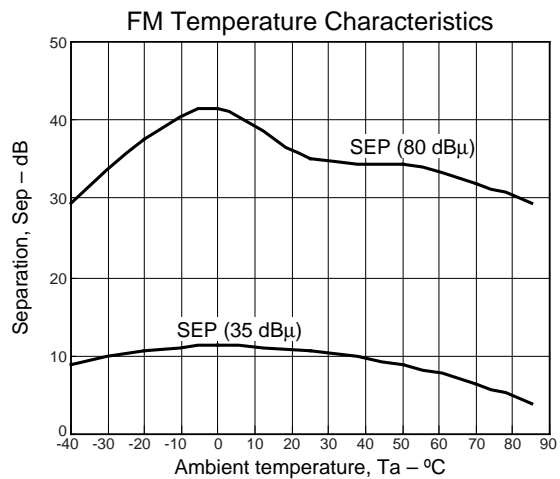
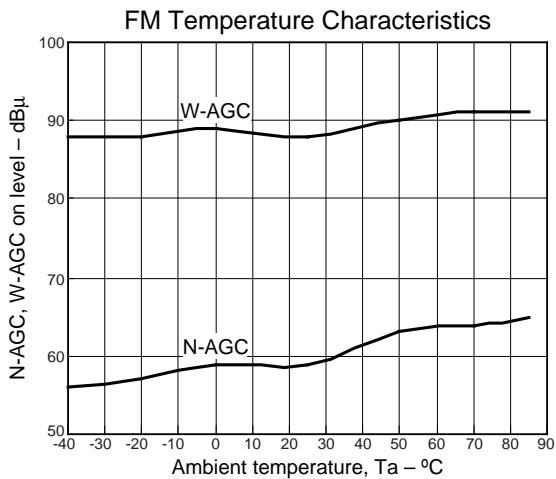
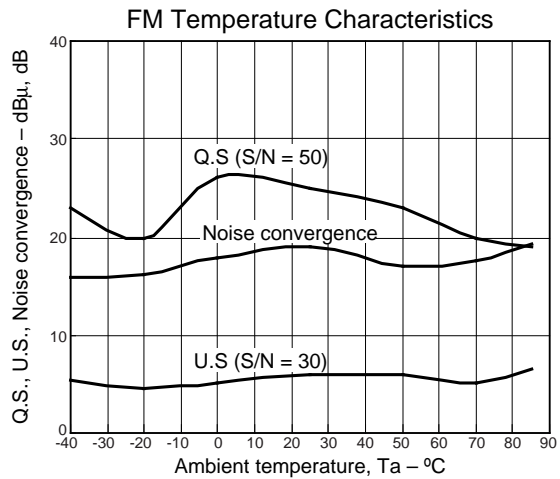
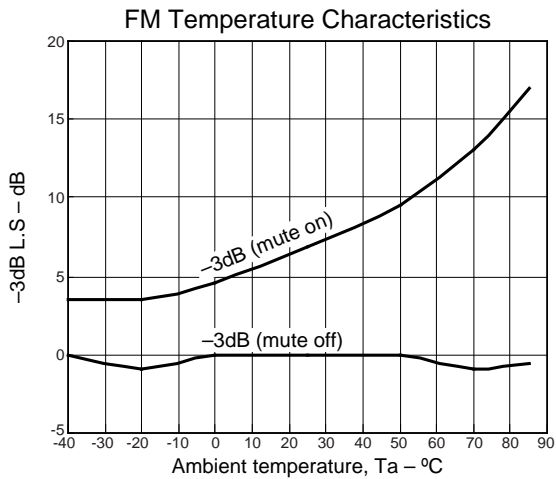
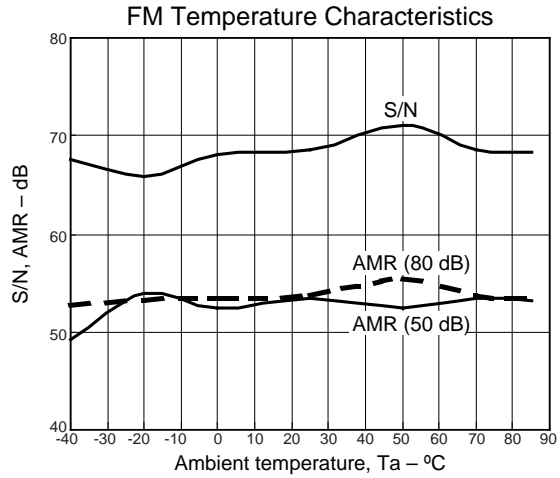
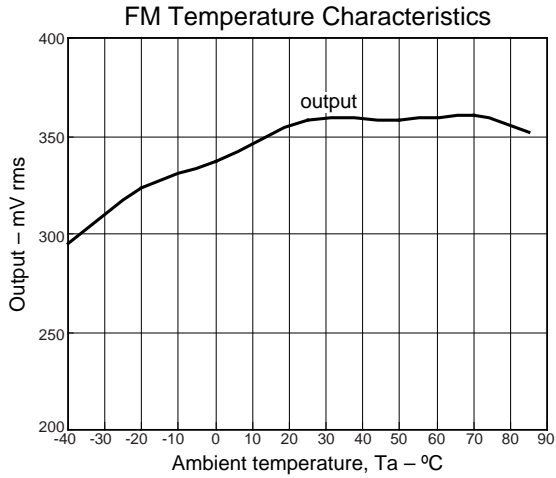

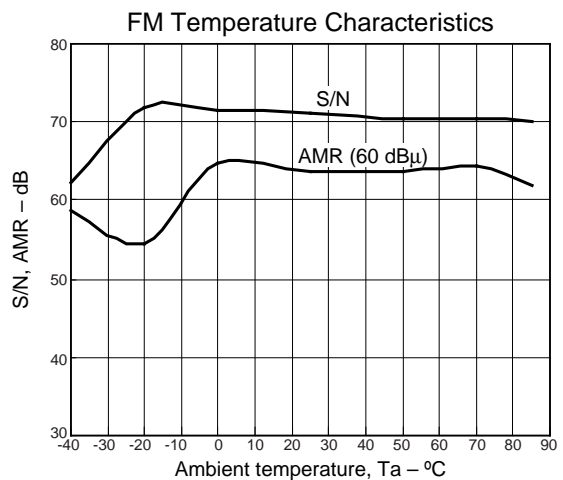
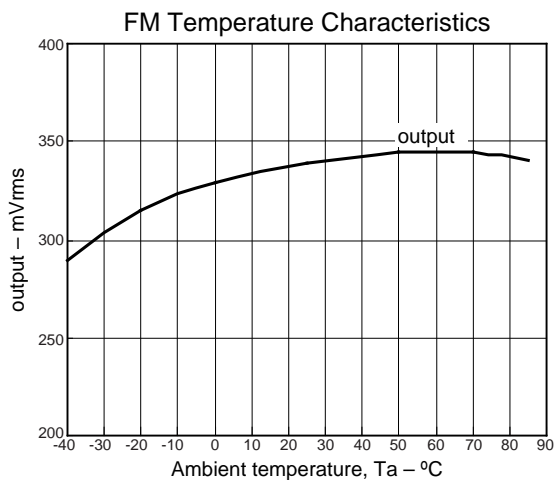
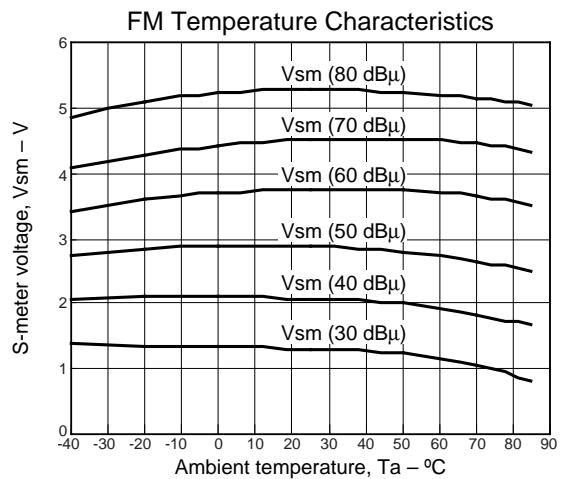
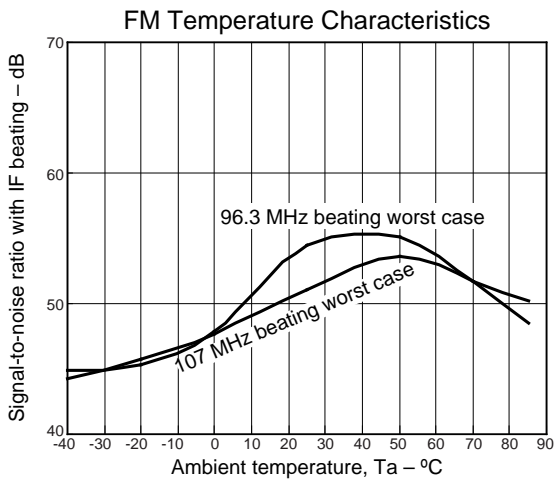
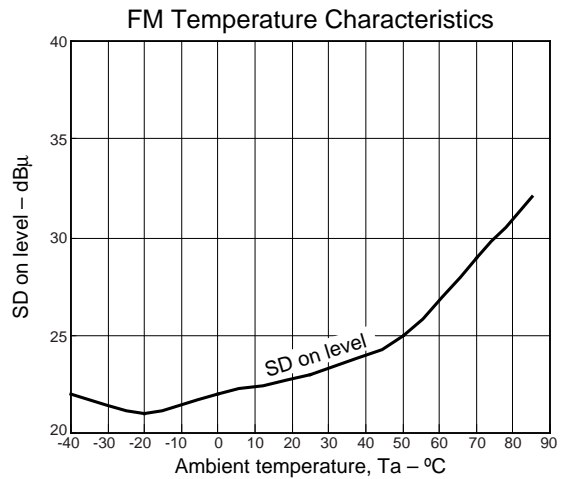
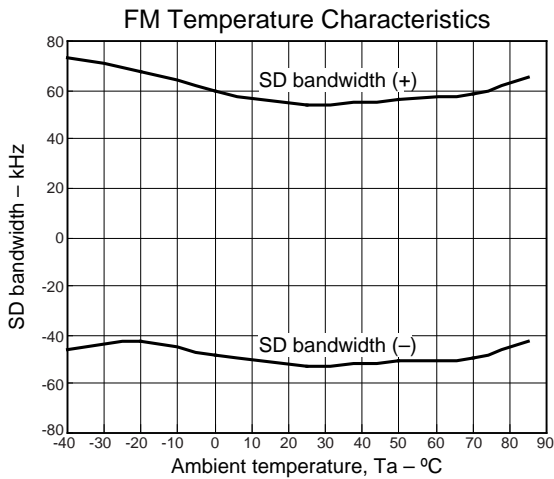
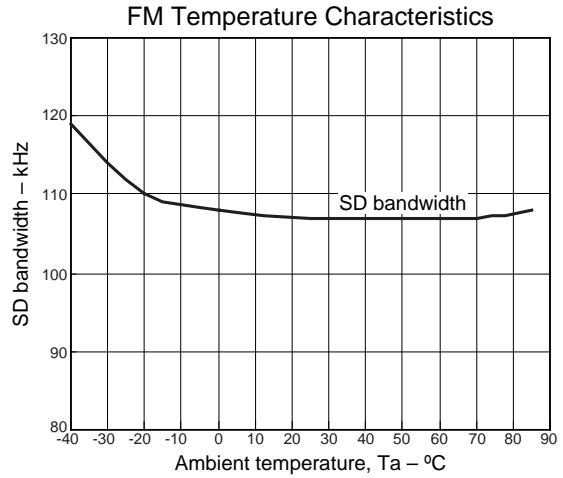
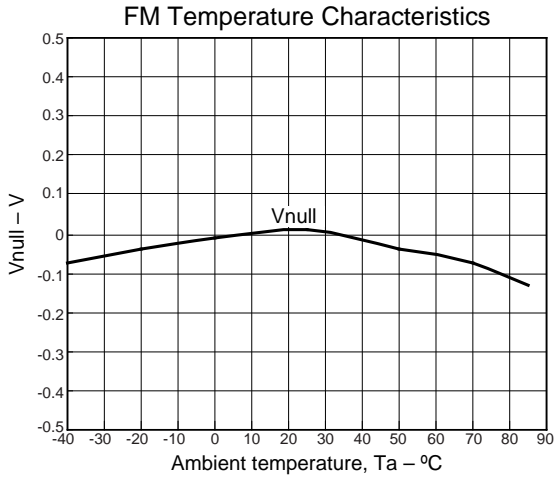

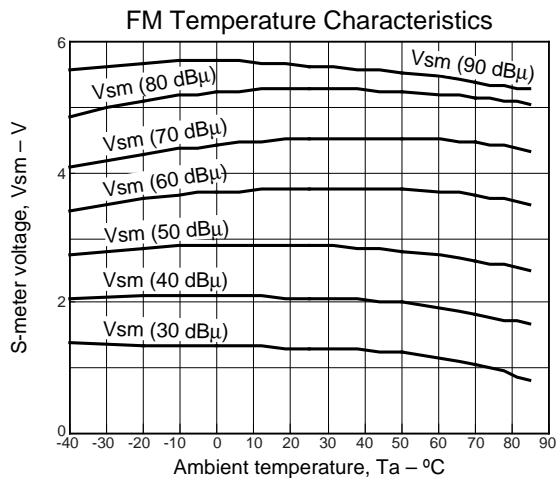
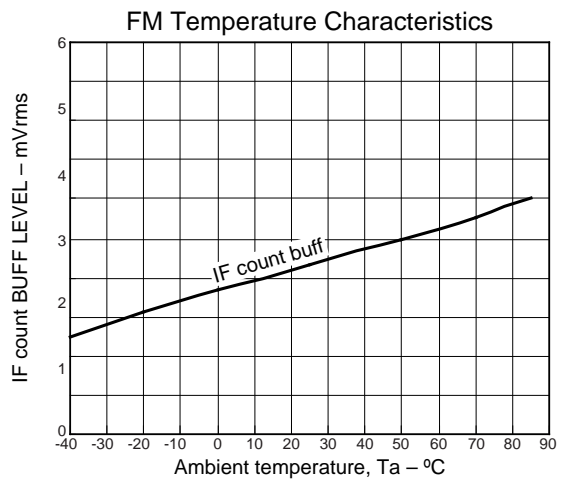
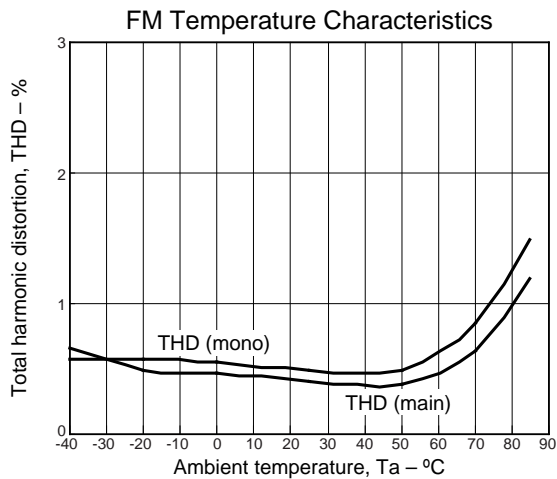
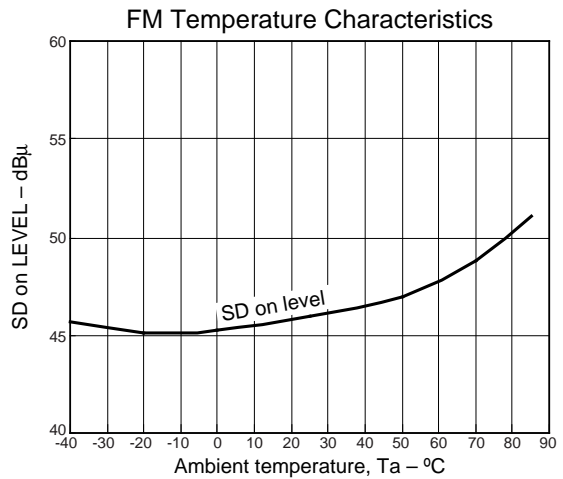
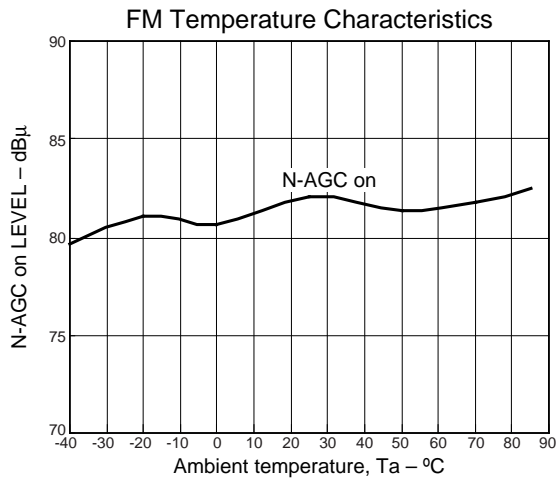
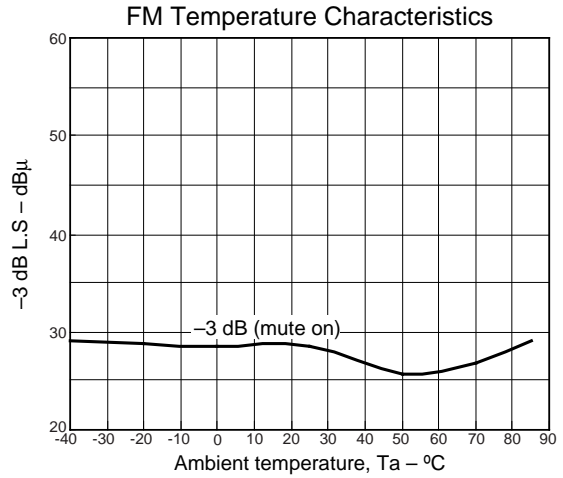
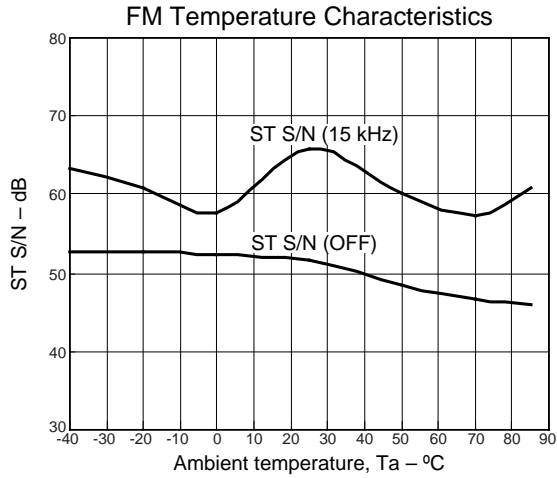

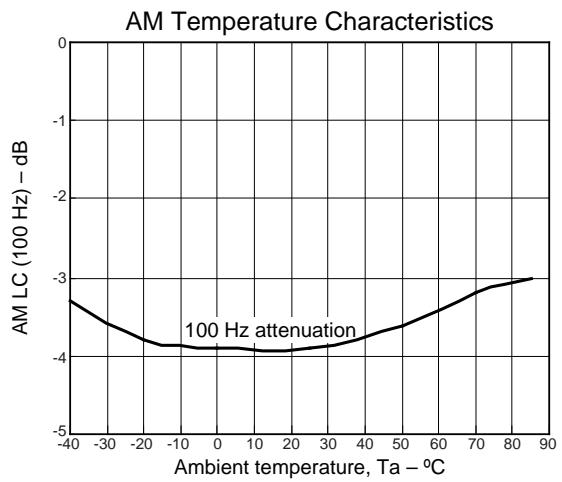
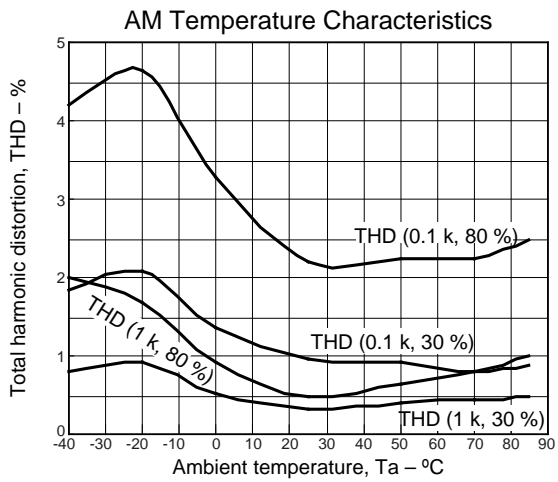
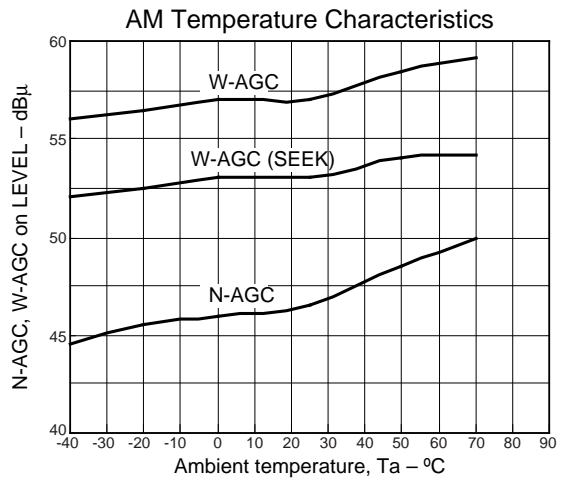
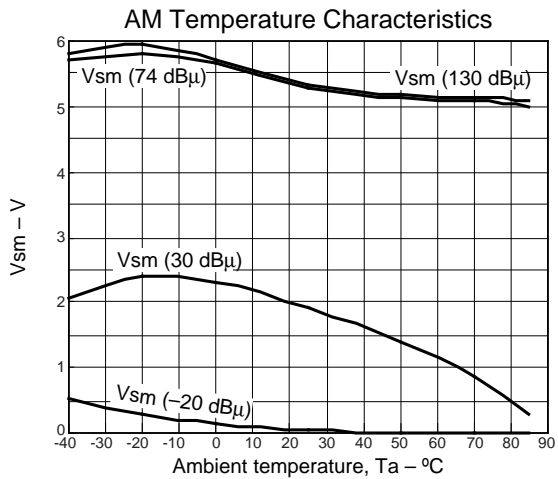
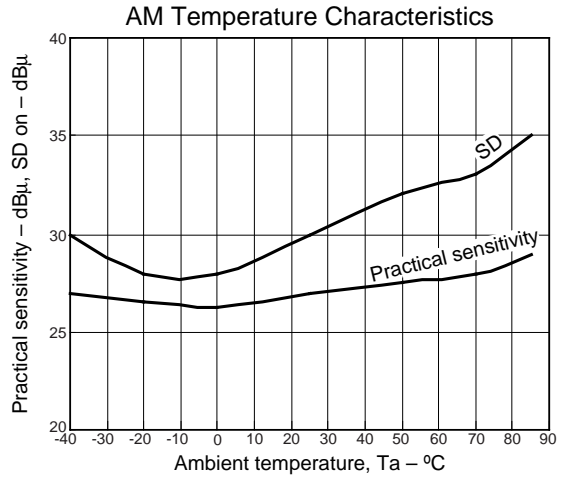
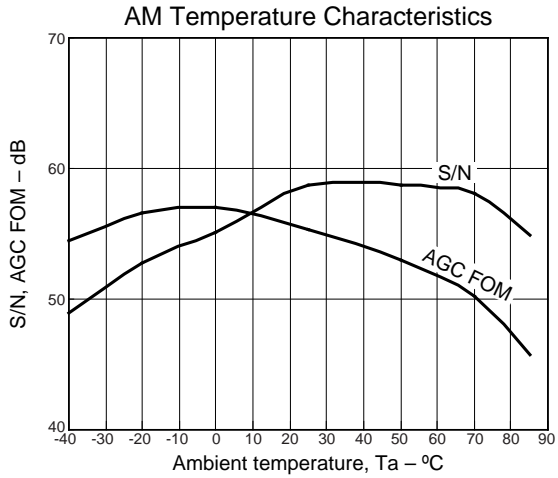

- Specifications of any and all SANYO products described or contained herein stipulate the performance, characteristics, and functions of the described products in the independent state, and are not guarantees of the performance, characteristics, and functions of the described products as mounted in the customer's products or equipment. To verify symptoms and states that cannot be evaluated in an independent device, the customer should always evaluate and test devices mounted in the customer's products or equipment.
- SANYO Electric Co., Ltd. strives to supply high-quality high-reliability products. However, any and all semiconductor products fail with some probability. It is possible that these probabilistic failures could give rise to accidents or events that could endanger human lives, that could give rise to smoke or fire, or that could cause damage to other property. When designing equipment, adopt safety measures so that these kinds of accidents or events cannot occur. Such measures include but are not limited to protective circuits and error prevention circuits for safe design, redundant design, and structural design.
- In the event that any or all SANYO products(including technical data, services) described or contained herein are controlled under any of applicable local export control laws and regulations, such products must not be exported without obtaining the export license from the authorities concerned in accordance with the above law.
- No part of this publication may be reproduced or transmitted in any form or by any means, electronic or mechanical, including photocopying and recording, or any information storage or retrieval system, or otherwise, without the prior written permission of SANYO Electric Co., Ltd.
- Any and all information described or contained herein are subject to change without notice due to product/technology improvement, etc. When designing equipment, refer to the "Delivery Specification" for the SANYO product that you intend to use.
- Information (including circuit diagrams and circuit parameters) herein is for example only ; it is not guaranteed for volume production. SANYO believes information herein is accurate and reliable, but no guarantees are made or implied regarding its use or any infringements of intellectual property rights or other rights of third parties.

This catalog provides information as of July, 2005. Specifications and information herein are subject to change without notice.