

CONSTANT CURRENT LED DRIVER with PWM CONTROL

■ GENERAL DESCRIPTION

The NJU6080 is a constant current LED driver with PWM control.

NJU6080 can reduce board density compared with the case composed discrete because the constant current value can be set with one resistance.

It can contribute to the reliability improvement of the system because it has an over current protection circuit and thermal shutdown circuit.

The NJU6080 is suited for a LCD back light and toys, etc.

■ PACKAGE OUTLINE

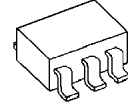

NJU6080F1

■ FEATURES

- Supply Voltage Range : 2.5V ~ 5.5V
- LED Output Current : 100mA (max.)
- Output Current Accuracy : $\pm 1.8\%$
- Operating Current : 150 μ A (typ.)
- One white LED can be lit.
- External Parts : Current limitation resistance
- Internal Thermal Overload Protection
- Internal Over Current Protection
- CMOS Technology
- Package Outline : SOT-23-6

■ BLOCK DIAGRAM

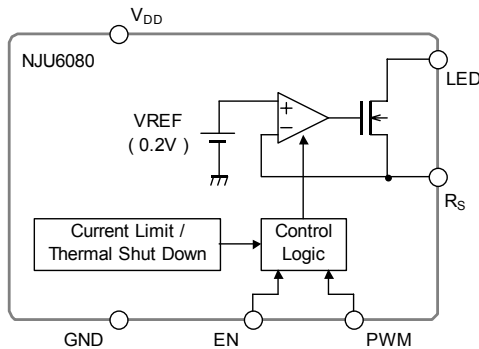

■ PIN CONFIGURATION

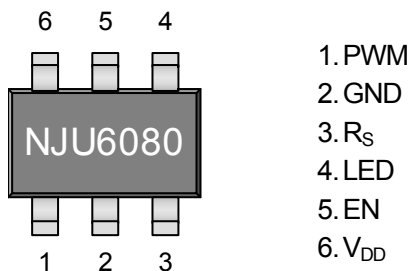

■ ABSOLUTE MAXIMUM RATINGS

($T_a = 25^\circ\text{C}$)

PARAMETER	SYMBOL	RATINGS	UNIT
Supply Voltage	V_{DD}	- 0.3 ~ + 7.0	V
Output Voltage	V_{LED}	- 0.3 ~ + 7.0	V
Output Current	I_{LED}	200	mA
EN Pin Voltage	V_{EN}	+ 7.0 (*1)	V
PWM Pin Voltage	V_{PWM}	+ 7.0 (*1)	V
Power Dissipation	P_D	400 (*2)	MW
Operating Temperature	T_{opr}	- 40 ~ + 85	$^\circ\text{C}$
Storage Temperature	T_{stg}	- 40 ~ + 125	$^\circ\text{C}$

(*1) : When input voltage is less than +7V, the absolute maximum control voltage is equal to the input voltage.

(*2) : Mounted on glass epoxy board (76.2 × 114.3 × 1.6mm: 2Layers FR-4)

■ RECOMMENDED OPERATING CONDITION

($T_a = 25^\circ\text{C}$)

PARAMETER	SYMBOL	CONDITIONS	MIN.	TYP.	MAX.	UNIT
Supply Voltage	V_{DD}		2.5	-	5.5	V
Output Voltage	V_{LED}		-	-	5.5	V

■ ELECTRICAL CHARACTERISTICS

($V_{DD} = 3.0\text{V}$, $V_{LED} = 0.5\text{V}$, $R_S = 10\Omega$, $V_{EN} = V_{PWM} = V_{DD}$, $T_a = 25^\circ\text{C}$)

PARAMETER	SYMBOL	CONDITIONS	MIN.	TYP.	MAX.	UNIT
Quiescent Current	I_{DD}		-	150	260	μA
Quiescent Current at OFF	I_{DD_OFF}	$V_{EN} = \text{GND}$	-	-	0.1	μA
Output Current Accuracy	ΔI_{LED}		- 1.8	-	+ 1.8	%
Output Pin Voltage 1	V_{LED1}	$I_{LED} = 20\text{mA}$	-	0.3	0.4	V
Output Pin Voltage 2	V_{LED2}	$I_{LED} = 100\text{mA}$	-	0.4	0.5	V
Output Pin Leak Current 1	I_{LEAK1}	$V_{EN} = \text{GND}$, $V_{DD} = V_{LED} = 5.5\text{V}$	-	-	0.1	μA
Output Pin Leak Current 2	I_{LEAK2}	$V_{PWM} = \text{GND}$, $V_{DD} = V_{LED} = 5.5\text{V}$	-	-	0.1	μA
EN Pin ON Voltage	V_{EN_ON}	$I_{LED} = \text{OFF} \rightarrow \text{ON}$	1.6	-	V_{DD}	V
EN Pin OFF Voltage	V_{EN_OFF}	$I_{LED} = \text{ON} \rightarrow \text{OFF}$	0	-	0.3	V
PWM Pin ON Voltage	V_{PWM_ON}	$I_{LED} = \text{OFF} \rightarrow \text{ON}$	$0.7V_{DD}$	-	V_{DD}	V
PWM Pin OFF Voltage	V_{PWM_OFF}	$I_{LED} = \text{ON} \rightarrow \text{OFF}$	0	-	$0.3V_{DD}$	V
EN Pin Input Current	I_{EN}		-	-	0.1	μA
PWM Pin Input Current	I_{PWM}		-	-	0.1	μA
R_S Pin Leak Current	I_{LEAK_RS}	$V_{EN} = \text{GND}$, $V_{RS} = V_{LED} = 3\text{V}$	-	-	0.1	μA
PWM Pin ON Delay Time	t_{PWM_ON}	$V_{PWM} = \text{L} \rightarrow \text{H}$	-	2.5	-	μs
PWM Pin OFF Delay Time	t_{PWM_OFF}	$V_{PWM} = \text{H} \rightarrow \text{L}$	-	0.1	-	μs
Maximum Output Current	I_{LED_MAX}	$R_S = 0\Omega$	100	200	-	mA

■ APPLICATION CIRCUIT

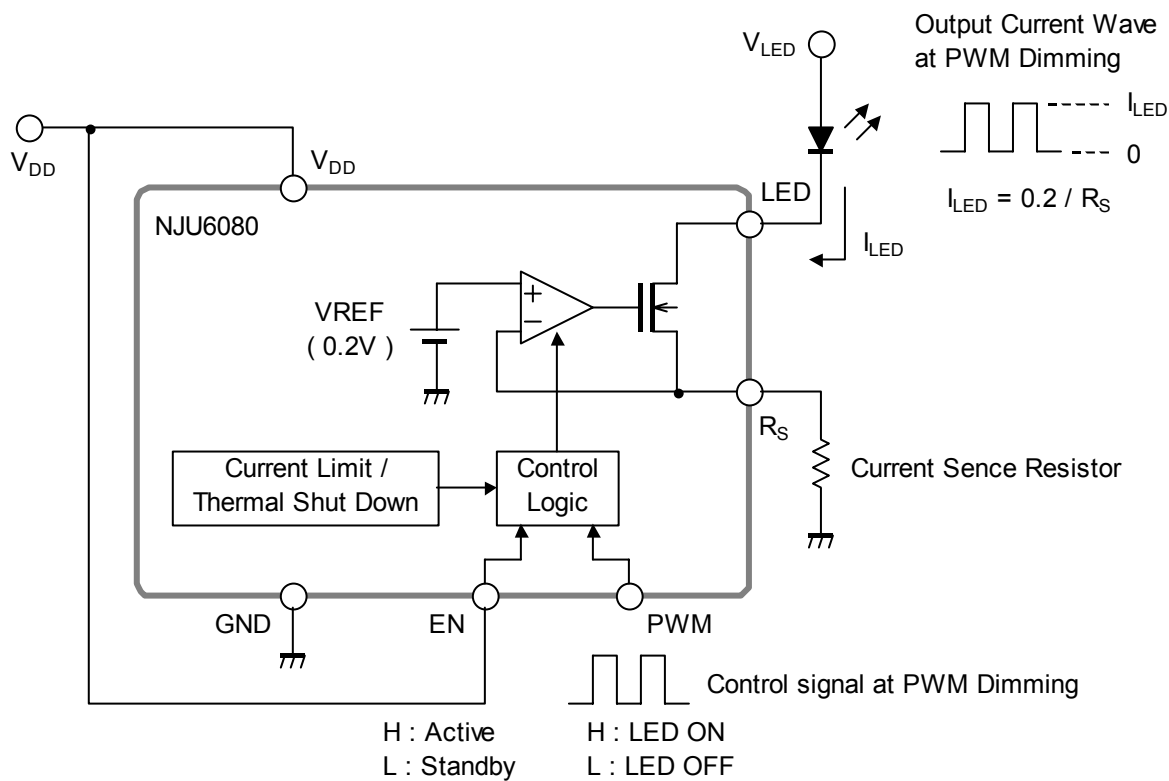

■ TYPICAL CHARACTERISTICS

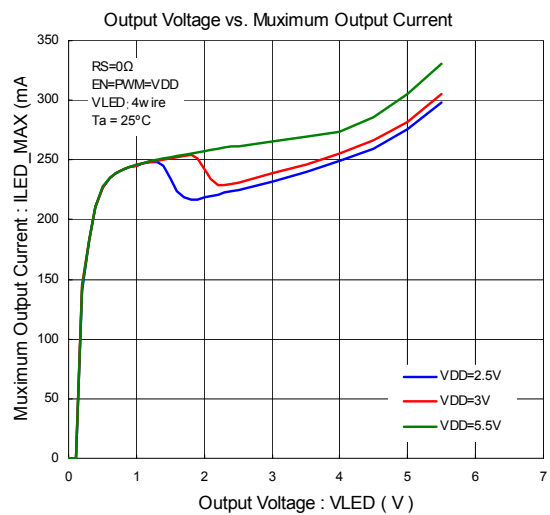
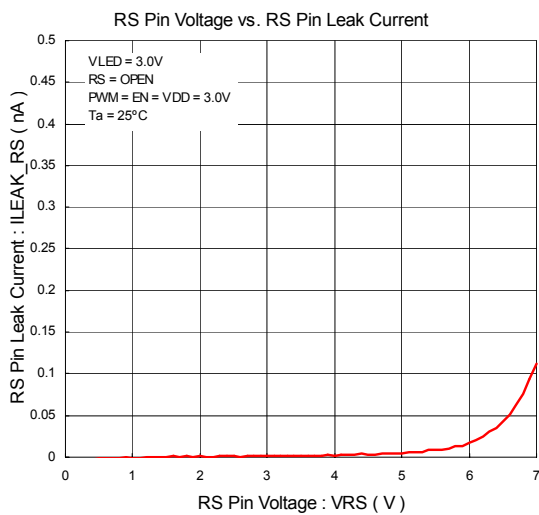
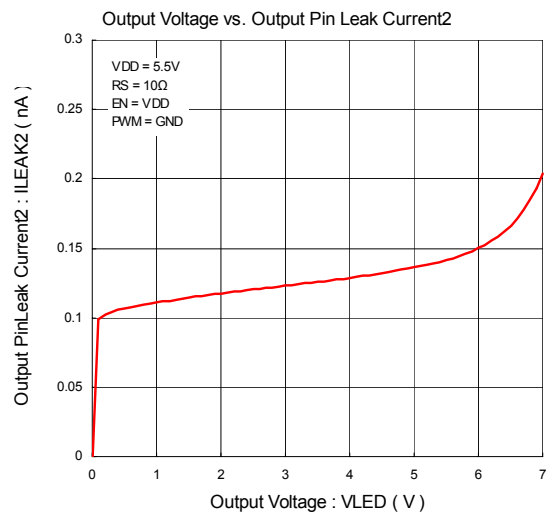
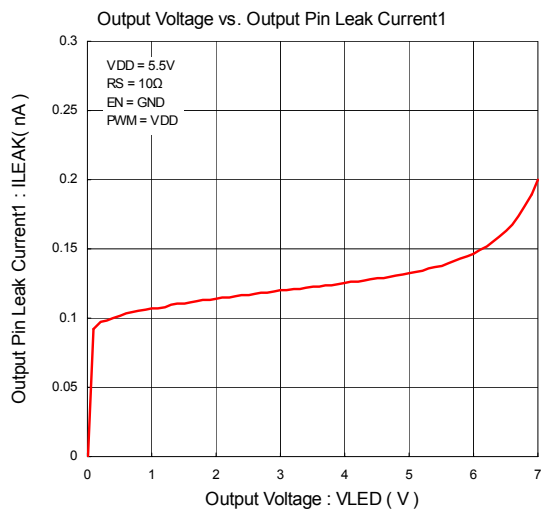
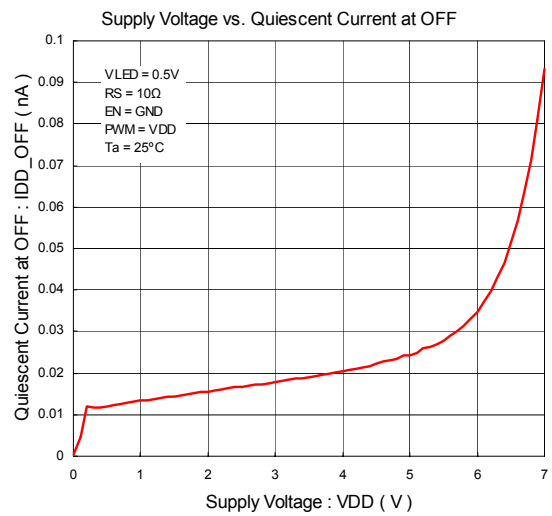
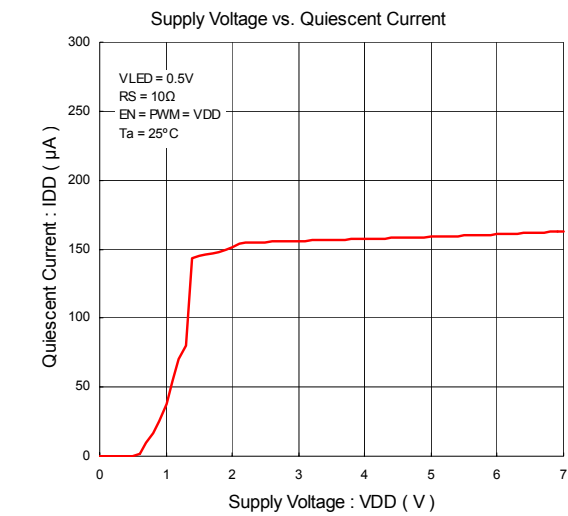

■ TYPICAL CHARACTERISTICS

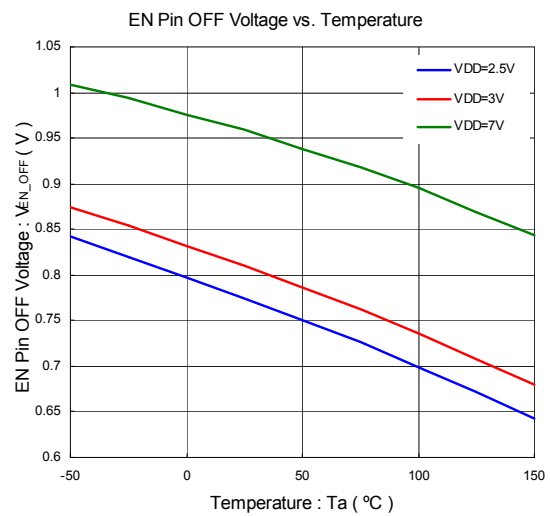
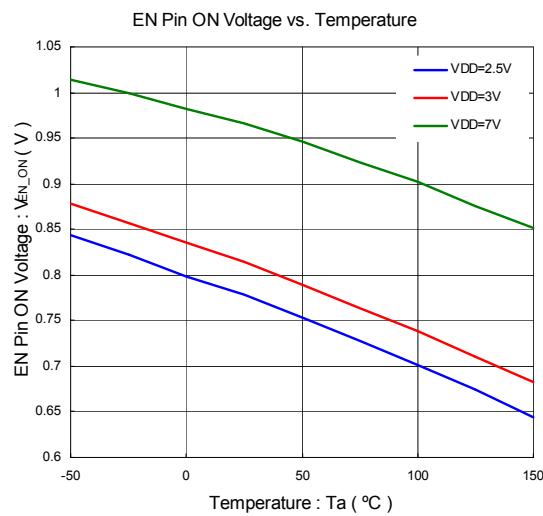
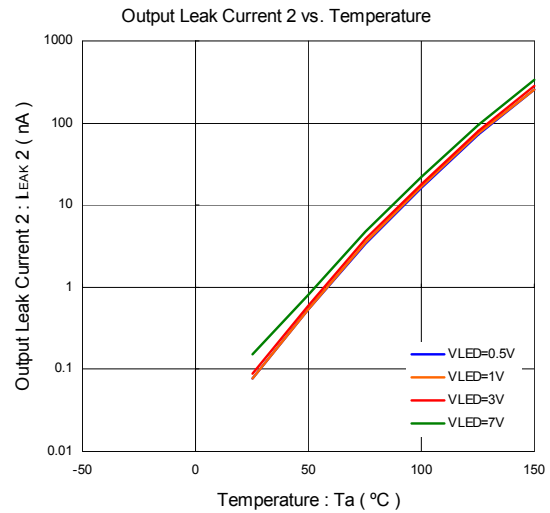
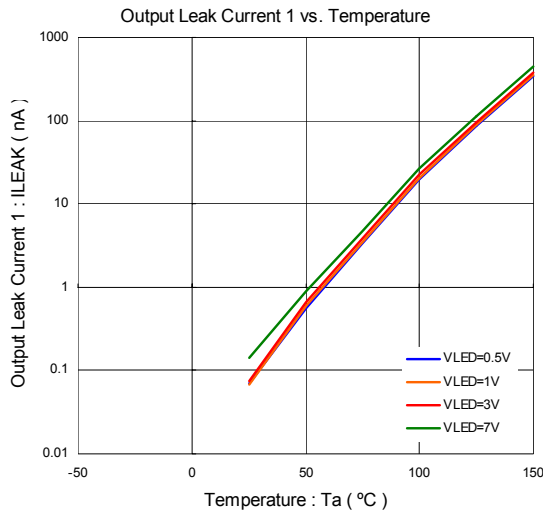
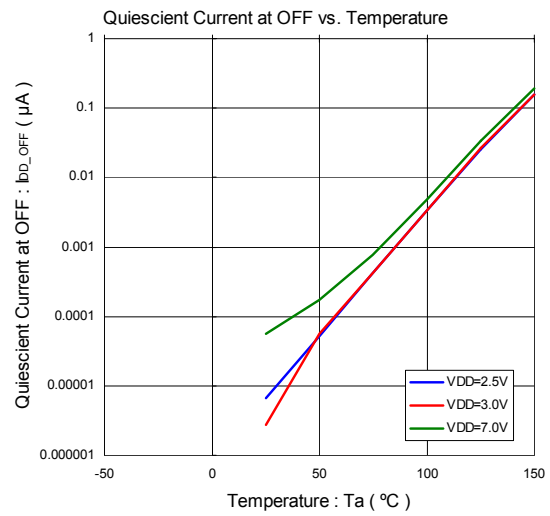
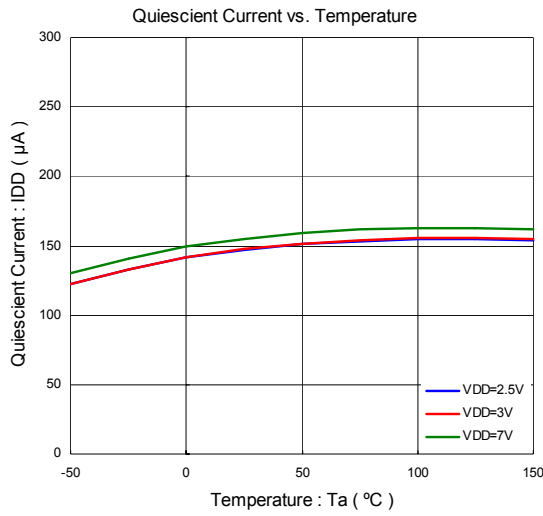

■ TYPICAL CHARACTERISTICS

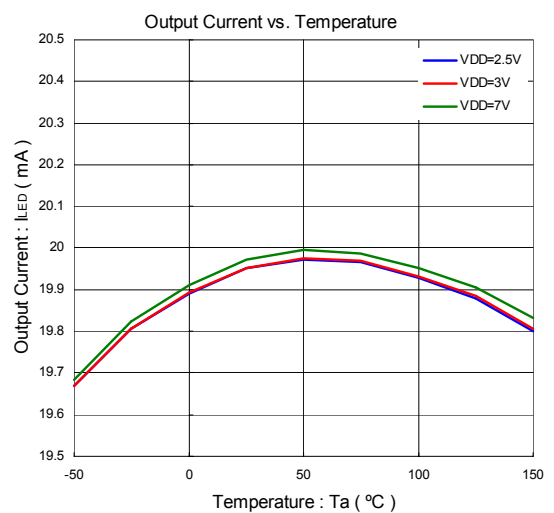
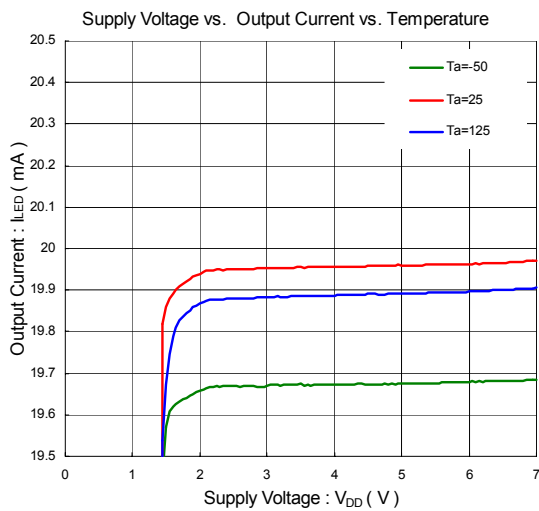
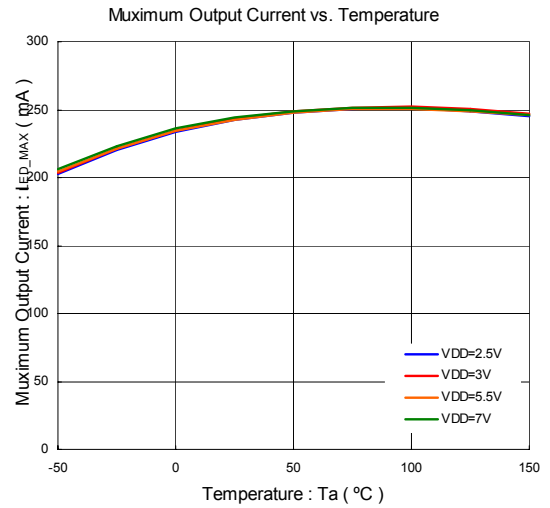
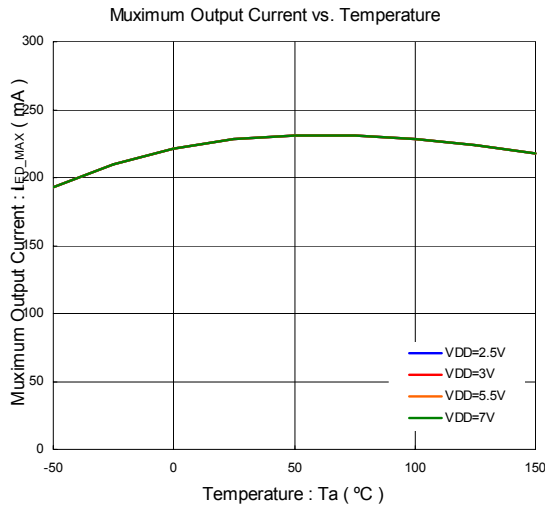
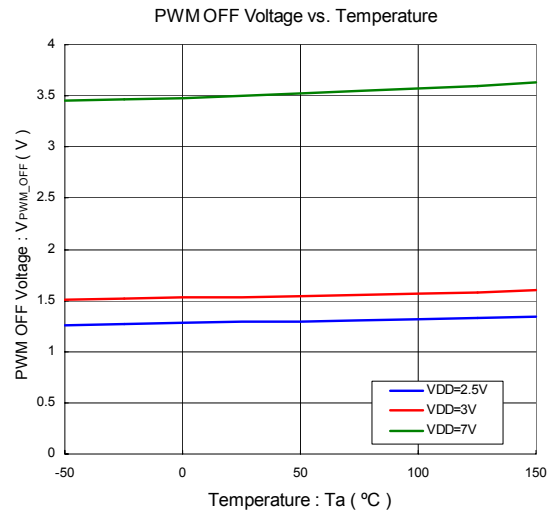
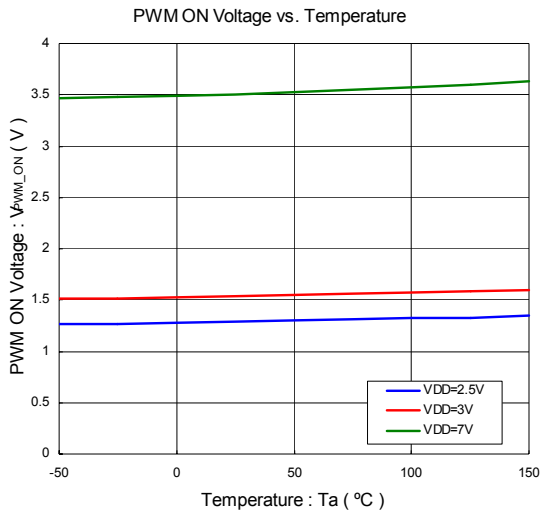

■ TYPICAL CHARACTERISTICS

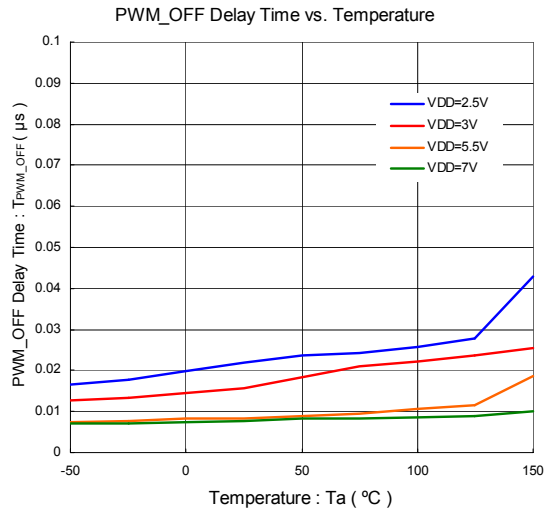
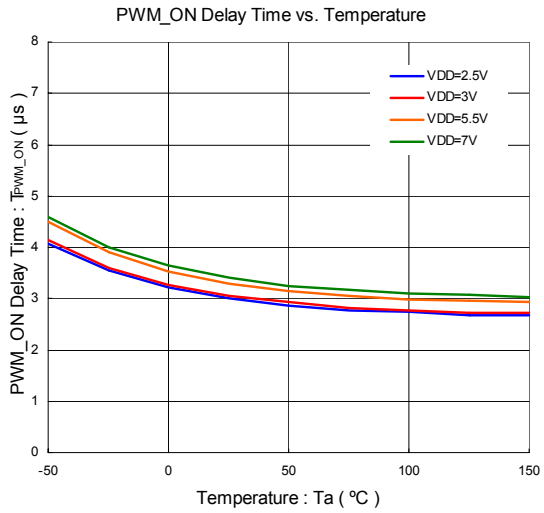
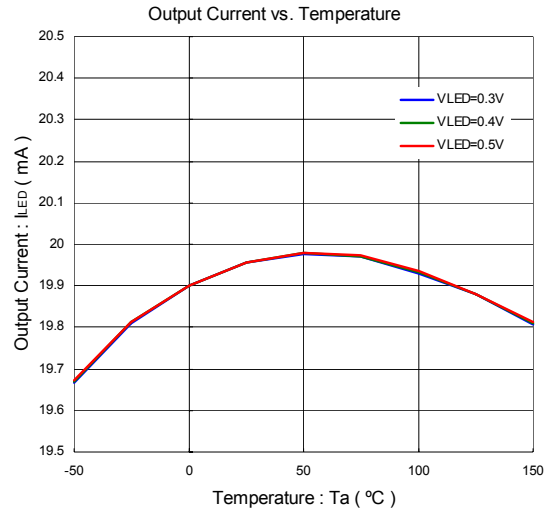
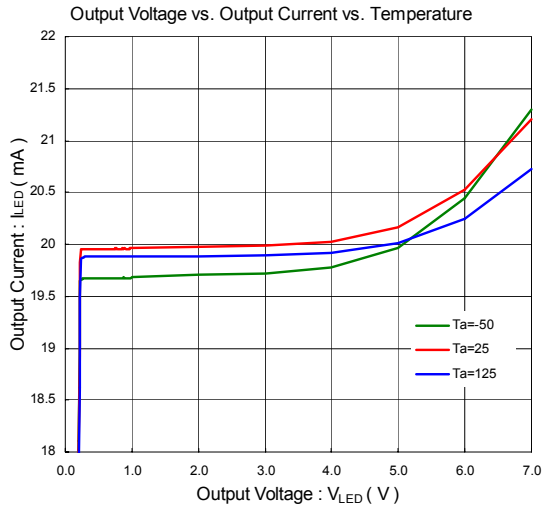

[CAUTION]

The specifications on this databook are only given for information, without any guarantee as regards either mistakes or omissions. The application circuits in this databook are described only to show representative usages of the product and not intended for the guarantee or permission of any right including the industrial rights.