

OBSOLETE PRODUCT
 Contact factory for replacement model



PWR60XX

1.8 WATT REGULATED DC/DC CONVERTER

FEATURES

- | Low Cost
- | Low Noise
- | Industry-Standard Package
- | Single and Dual Outputs
- | High Isolation Voltage Option Available
- | Linear Output Regulation
- | Internal Input and Output Filtering
- | Low EMI Transformer Design
- | No External Components Required
- | Thermal Shutdown Protection

DESCRIPTION

The PWR60XX Series offers a low-cost alternative for some of the most popular DC/DC converters industry wide. Each model has very low noise and an outstanding MTTF. The superior reliability, excellent filtering, and low cost make it an excellent choice for industry-standard usage.

The series includes eleven models (other input and output voltages are available upon request), all set in an encapsulant for excellent thermal dissipation for internal components. The use of surface-mount devices and manufacturing processes combined with the encapsulation process, provides the user a product that is more environmentally rugged.

The PWR60XX has full isolation between input and output to give the designer maximum flexibility in grounding options and polarity configurations. The outputs are protected against shorts to increase the units survivability in harsh environments.

MECHANICAL

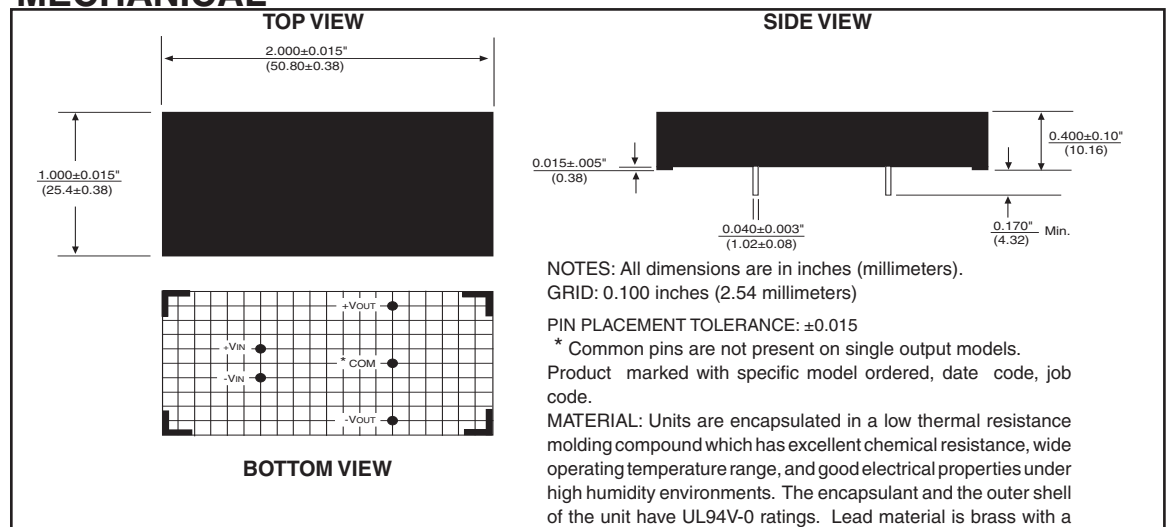

ELECTRICAL SPECIFICATIONS

Specifications typical at $T_A = +25^\circ\text{C}$, rated input voltage, rated output current unless otherwise specified.

MODEL	NOMINAL INPUT VOLTAGE (V _{dc})	RATED OUTPUT VOLTAGE (V _{dc})	RATED OUTPUT CURRENT (mA)	INPUT CURRENT		REFLECTED RIPPLE CURRENT (mA _{p-p})	EFFICIENCY (%)
				NO LOAD (mA)	RATED LOAD (mA)		
PWR6000	5	5	360	70	655	15	55
PWR6004	5	±12	±75	70	570	15	63
PWR6005	5	±15	±60	70	555	15	65
PWR6006	12	5	360	30	275	10	55
PWR6010	12	±12	±75	30	240	10	63
PWR6011	12	±15	±60	30	230	10	65
PWR6012	15	5	360	25	220	8	55
PWR6016	15	±12	±75	25	190	8	63
PWR6017	15	±15	±60	25	185	8	65
PWR6018	24	5	360	13	120	12	62
PWR6023	24	±15	±60	13	120	12	62

ABSOLUTE MAXIMUM RATINGS

Output Short-Circuit Duration
 Outputs to Common Continuous
 Output to Output Momentary
 Output Power 2.0W
 Lead Temperature +300°C
 (soldering, 10 seconds max)

NOTE: Other input to output voltages may be available. Please consult factory.

Specifications typical at $T_A = +25^\circ\text{C}$, rated input voltage, rated output current unless otherwise specified.

PARAMETER	CONDITIONS	MIN	TYP	MAX	UNITS
INPUT	PWR6000	4.65	5.0	5.5	V _{DC}
	PWR6004	4.65	5.0	5.5	V _{DC}
	PWR6005	4.65	5.0	5.5	V _{DC}
	PWR6006	10.9	12.0	13.2	V _{DC}
	PWR6010	10.9	12.0	13.2	V _{DC}
	PWR6011	10.9	12.0	13.2	V _{DC}
	PWR6012	13.9	15.0	16.5	V _{DC}
	PWR6016	13.9	15.0	16.5	V _{DC}
	PWR6017	13.9	15.0	16.5	V _{DC}
	PWR6018	21.6	24	26.4	V _{DC}
	PWR6023	21.6	24	26.4	V _{DC}
ISOLATION (Standard)					
Rated Voltage		500			V _{DC}
Test Voltage		500			V _{pk}
Resistance			10		GΩ
Capacitance			27		pF
Leakage Current	V _{ISO} = 240V _{AC} , 60Hz			5	μArms
ISOLATION (-HV Option)					
Rated Voltage		1000			V _{DC}
Test Voltage		3000			V _{pk}
Resistance			10		GΩ
Capacitance			27		pF
Leakage Current	V _{ISO} = 240V _{AC} , 60Hz			5	μArms
OUTPUT					
Rated Power	-25°C T _A +70°C		1.8		Watts
Voltage Setpoint Accuracy	Rated Load, Nominal Vin			±2	%
Temperature Coefficient			±0.01		%/°C
Ripple and Noise	BW = DC to 10MHz		20	45	mVp-p
REGULATION					
Line	High Line to Low Line		±0.2	±1.0	%
Load	Full Load to No Load		0.5	1.0	%
GENERAL					
Switching Frequency			150		kHz
Package Weight			20		g
MTTF per MIL-HDBK-217, RevE	Circuit Stress Method		930,000		Hr
TEMPERATURE					
Specification		-25	+25	+70	°C
Operation		-25		+100	°C
Storage		-40		+110	°C

TYPICAL APPLICATIONS

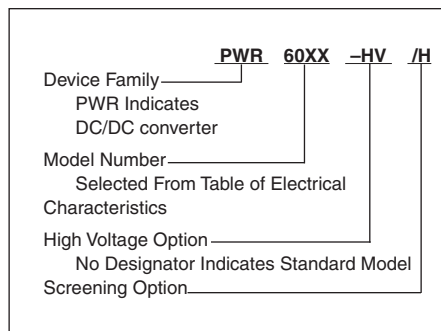
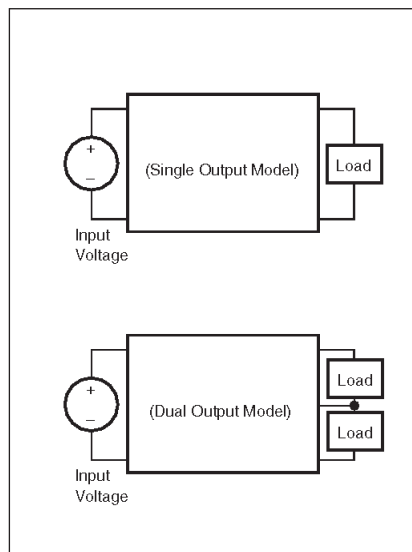

TYPICAL PERFORMANCE CURVES

$T_A = +25^\circ\text{C}$, Rated Input Voltage, Rated Output Current unless otherwise noted.

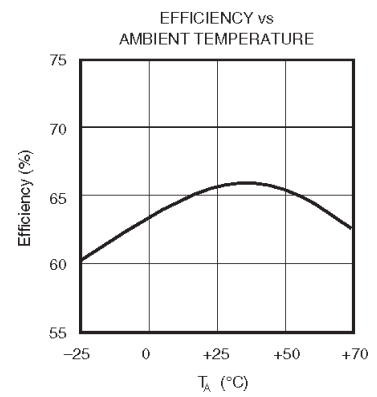
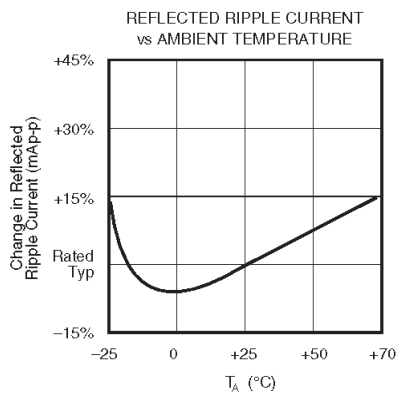
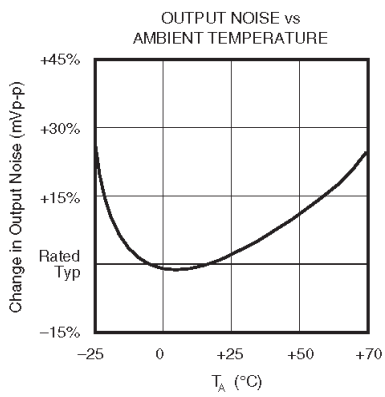
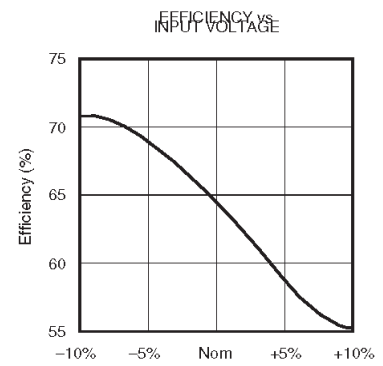
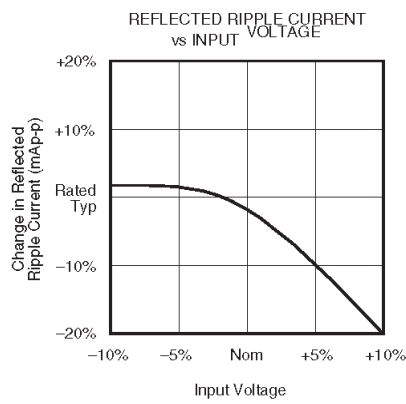
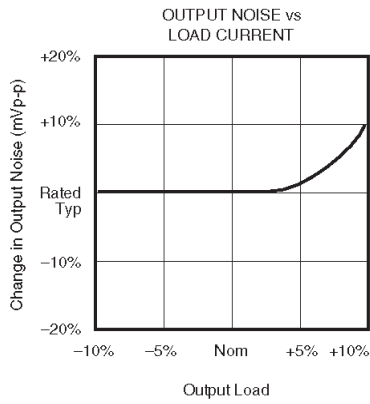
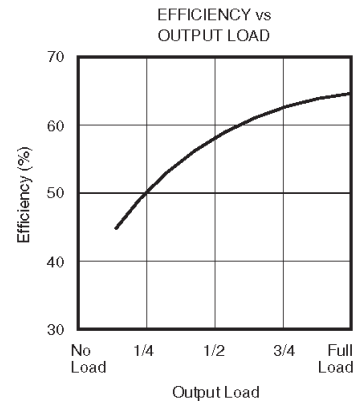
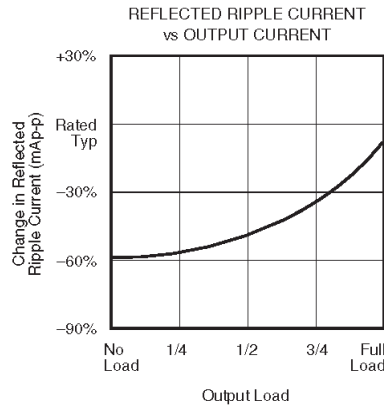
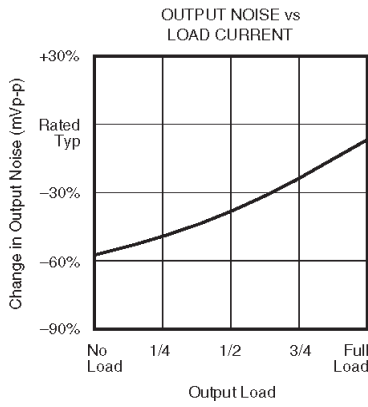

TYPICAL PERFORMANCE CURVES

$T_A = +25^\circ\text{C}$, Rated Input Voltage, Rated Output Current unless otherwise noted.

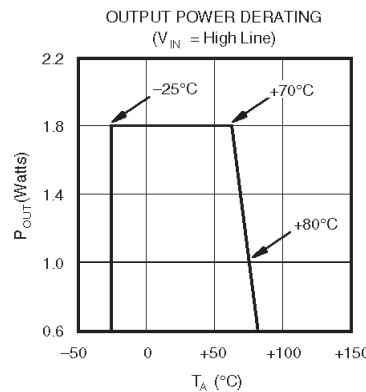
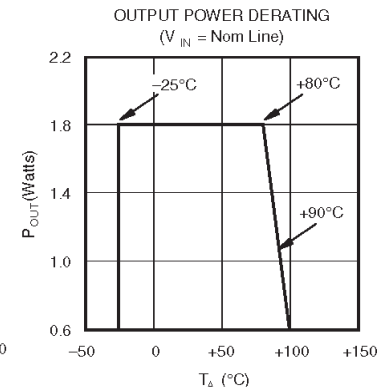
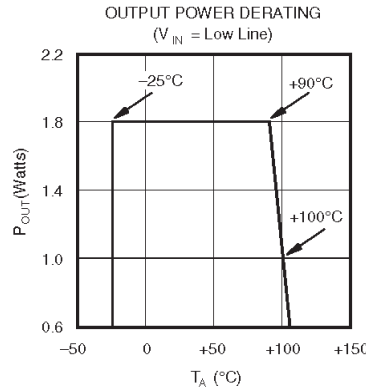
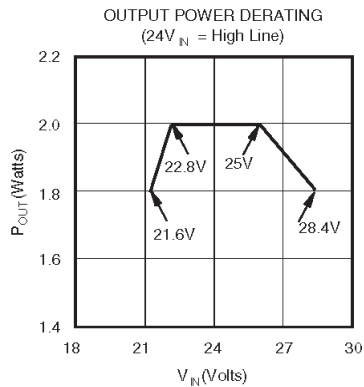
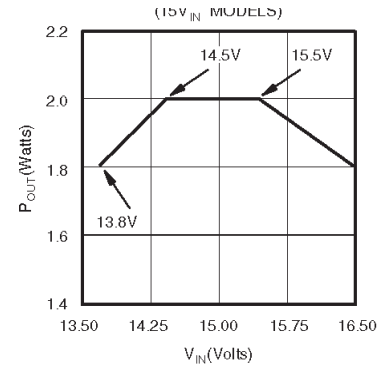
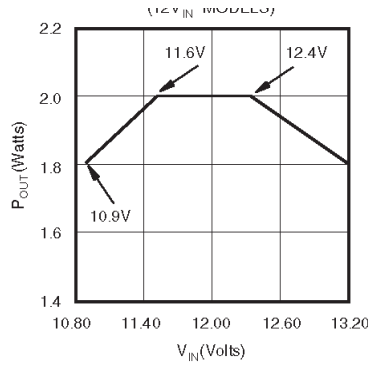
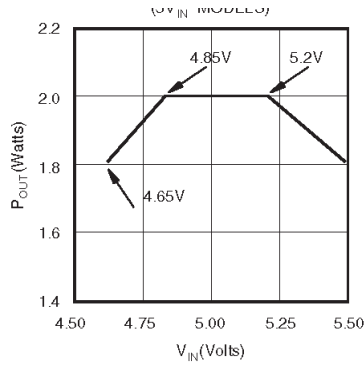

Murata Power Solutions, Inc.
 11 Cabot Boulevard, Mansfield, MA 02048-1151 U.S.A.
 Tel: (508) 339-3000 (800) 233-2765 Fax: (508) 339-6356
 www.murata-ps.com email: sales@murata-ps.com ISO 9001 & ISO 14001 REGISTERED

Murata Power Solutions, Inc. makes no representation that the use of its products in the circuits described herein, or the use of other technical information contained herein, will not infringe upon existing or future patent rights. The descriptions contained herein do not imply the granting of licenses to make, use, or sell equipment constructed in accordance therewith. Specifications are subject to change without notice. © 2009 Murata Power Solutions, Inc.

- USA:** Mansfield (MA), Tel: (508) 339 3000, email: sales@murata-ps.com
- Canada:** Toronto, Tel: (866) 740 1232, email: toronto@murata-ps.com
- UK:** Milton Keynes, Tel: +44 (0)1908 615232, email: mk@murata-ps.com
- France:** Montigny Le Bretonneux, Tel: +33 (0)1 34 60 01 01, email: france@murata-ps.com
- Germany:** München, Tel: +49 (0)89-544334-0, email: ped.munich@murata-ps.com
- Japan:** Tokyo, Tel: 3-3779-1031, email: sales_tokyo@murata-ps.com
Osaka, Tel: 6-6354-2025, email: sales_osaka@murata-ps.com
- China:** Shanghai, Tel: +86 215 027 3678, email: shanghai@murata-ps.com
Guangzhou, Tel: +86 208 221 8066, email: guangzhou@murata-ps.com
- Singapore:** Parkway Centre, Tel: +65 6348 9096, email: singapore@murata-ps.com