

Speaker / Headphone Amplifier Series

5W+5W

Stereo Speaker Amplifiers

BA5406, BA5417



•Description

The BA5406/BA5417 is a dual OTL monolithic power IC with two built-in, high output speaker amplifier circuits.

High output of 5W×2 can be produced when $V_{CC}=12\text{ V}$ and $R_L=3\Omega$, and 2.8 W×2 when $V_{CC}=9\text{ V}$ and $R_L=3\Omega$.

The BA5406, which uses a high allowable power dissipation package, has a simple heatsink design.

The BA5417 not only exceeds basic characteristics, but also has a built-in soft clip circuit, thermal shutdown and standby circuits.

•Features

BA5406

- 1) Good low voltage characteristics (Operation from $V_{CC}=5\text{ V}$)
- 2) Ripple filter (6pin) also can be used as muting pin (Make 6pin GND potential)
- 3) Small thermal resistance package and simple heatsink design

BA5417

- 1) Small pop noise when standby switches ON/OFF
- 2) Built-in circuit to prevent ripple addition when motor starts
- 3) Built-in thermal shutdown circuit
- 4) Built-in standby switch circuit
- 5) Built-in soft clip circuit

•Applications

Stereo radio cassette players, mini-audio systems, LCD TVs, etc.

•Product lineup

Part No.	BA5406	BA5417
Supply voltage [V]	5~15	6~15
Power dissipation [W]	20	15
Quiescent current [mA]	40	22
Standby current [$\mu\text{ A}$]	—	0
Closed loop voltage gain [dB]	46	45
Output noise voltage [mVrms]	0.6	0.3
Total harmonic distortion [%]	0.3	0.1
Ripple rejection [dB]	—	55
Package	SIP-M12	HSIP15

● **Absolute maximum ratings** (Ta=25°C)

Parameter	Symbol	Limits		Unit
		BA5406	BA5417	
Supply voltage	Vcc	18 * ¹	20 * ¹	V
Power dissipation	Pd	20 * ²	15 * ³	W
Operating temperature	Topr	-20~+75	-20~+75	°C
Storage temperature	Tstg	-30~+125	-55~+150	°C

*¹ When no signal

*² Back metal temperature 75°C

*³ Ta=75°C (Using infinite heatsink)

● **Operating range** (Ta=25°C)

Parameter	Symbol	Limits		Unit
		BA5406	BA5417	
Supply voltage	Vcc	5.0~15.0	6.0~15.0	V

● **Electrical characteristics** (BA5406 : Unless otherwise noted, Ta=25°C, Vcc=12V)
(BA5417 : Unless otherwise noted, Ta=25°C, Vcc=9V)

Parameter	Symbol	BA5406	BA5417	Unit.	Conditions	
Quiescent current	Io	40	22	mA	VIN=0Vms	
Rated output power	POUT	5.0	5.0	W	THD=10%, Ta=12V, RL=32Ω	
Closed loop voltage gain	Gvc	46	45	dB	—	
Output noise voltage	VNO	0.6	0.3	mVrms	Rg=10kΩ, DIN-Audio	
Total harmonic distortion	THD	0.3	0.1	%	POUT=0.5W, f=1kHz	
Ripple rejection	RR	—	55	dB	fRR=100Hz, VRR=-10dBm	
Crosstalk	CT	—	65	dB	VO=0dBm	
Standby current	Ioff	—	0	μA	—	
Standby pin input current	ISIN	—	0.15	mA	VSTBY=VCC	
Standby pin control voltage	Activated	VSTH	—	3.5~Vcc	V	—
	Not Activated	VSTL	—	0~1.2	V	—

* Note: This IC is not designed to be radiation-resistant.

● **Cautions on use**

- Numbers and data in entries are representative design values and are not guaranteed values of the items.
- Although ROHM is confident that the example application circuit reflects the best possible recommendations, be sure to verify circuit characteristics for your particular application. Modification of constants for other externally connected circuits may cause variations in both static and transient characteristics for external components as well as this Rohm IC. Allow for sufficient margins when determining circuit constants.
- Absolute maximum ratings**
Use of the IC in excess of absolute maximum ratings, such as the applied voltage or operating temperature range (Topr), may result in IC damage. Assumptions should not be made regarding the state of the IC (short mode or open mode) when such damage is suffered. A physical safety measure, such as a fuse, should be implemented when using the IC at times where the absolute maximum ratings may be exceeded.
- GND potential**
Ensure a minimum GND pin potential in all operating conditions. Make sure that no pins are at a voltage below the GND at any time, regardless of whether it is a transient signal or not.
- Thermal design**
Perform thermal design, in which there are adequate margins, by taking into account the permissible dissipation (Pd) in actual states of use.
- Short circuit between terminals and erroneous mounting**
Pay attention to the assembly direction of the ICs. Wrong mounting direction or shorts between terminals, GND, or other components on the circuits, can damage the IC.
- Operation in strong electromagnetic field**
Using the ICs in a strong electromagnetic field can cause operation malfunction.

●Block diagram

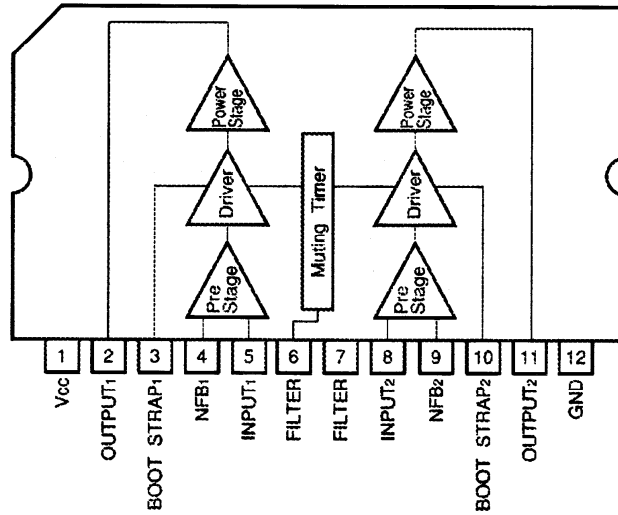

Fig.1 BA5406

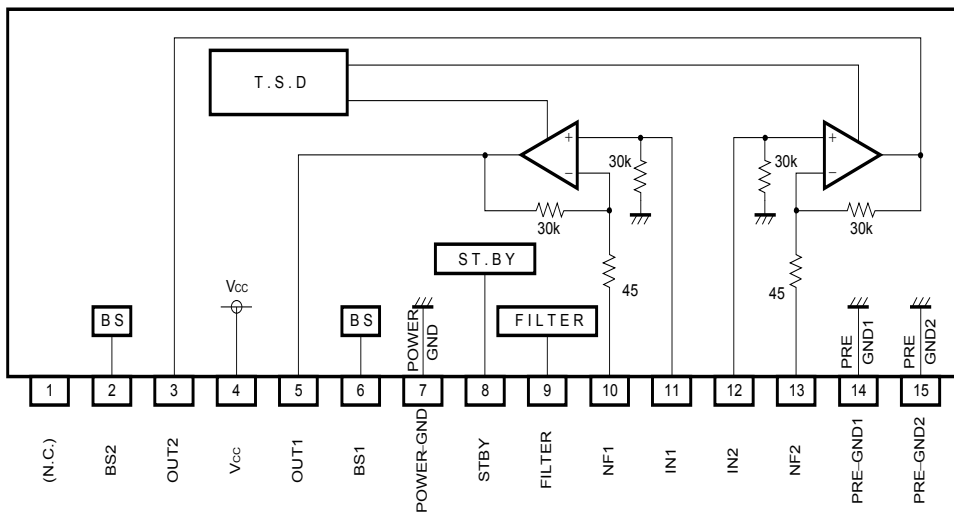

Fig.2 BA5417

●Measurement circuit

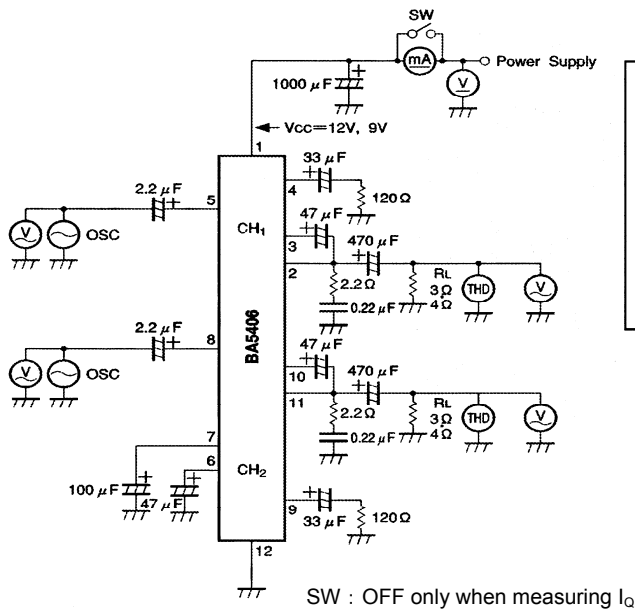

Fig.3 BA5406

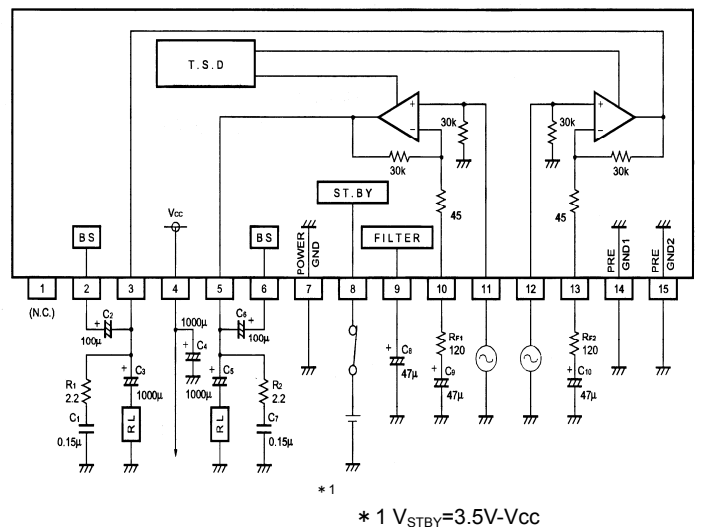
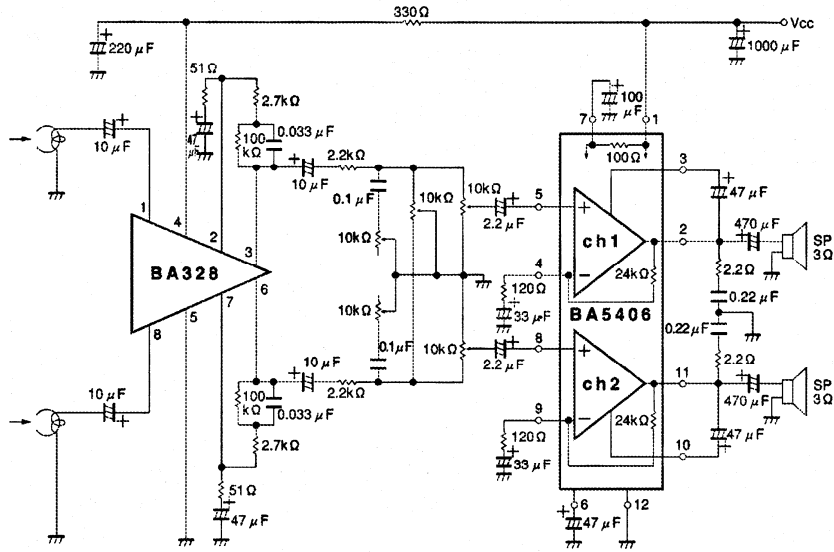

Fig.4 BA5417

●Application circuit
BA5406



BA5417

OTL mode circuit

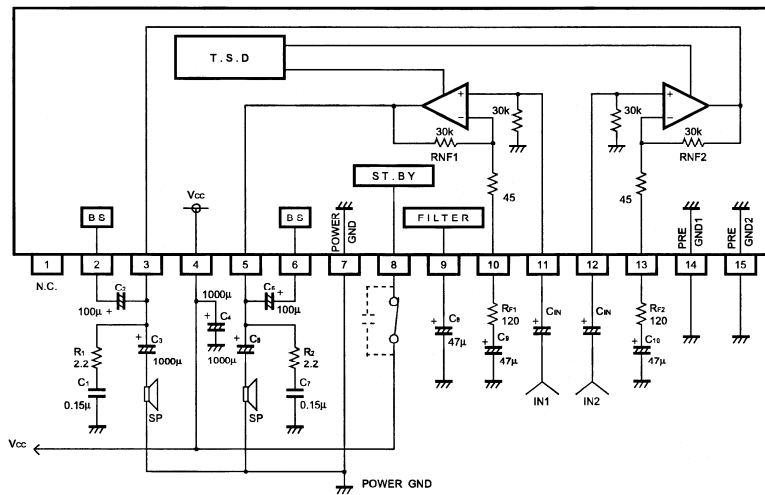

Fig.6

BTL mode circuit

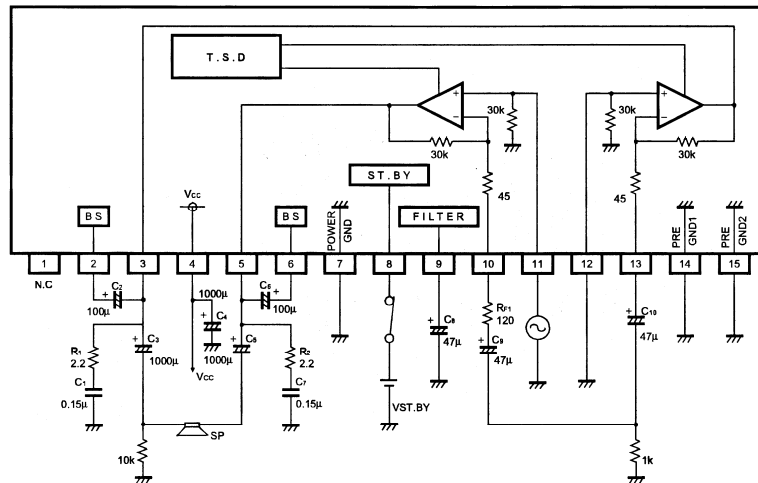

Fig.7

●Reference data

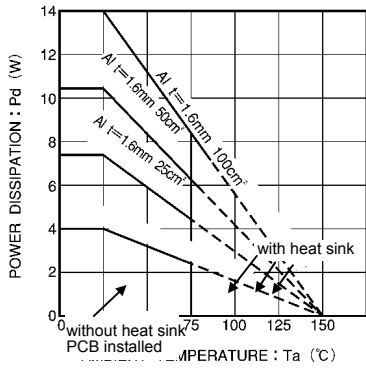

Fig.8 Thermal derating curve

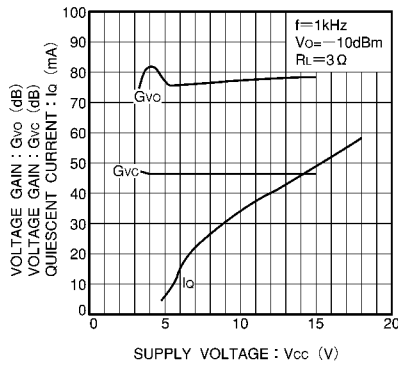

Fig.9 Quiescent current and voltage gain vs Supply voltage

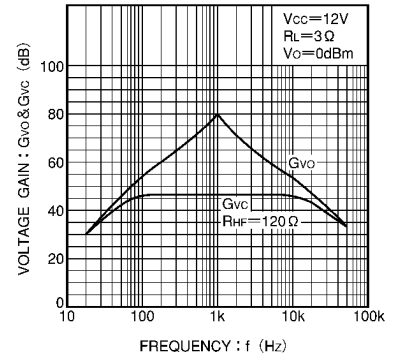

Fig.10 Voltage gain vs frequency

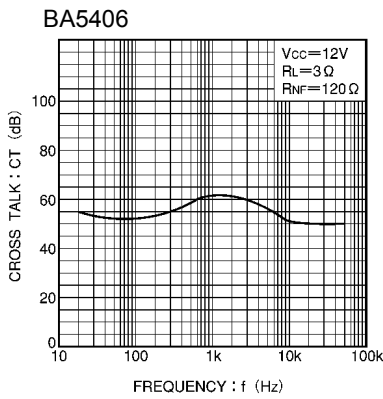

Fig.11 Crosstalk vs frequency

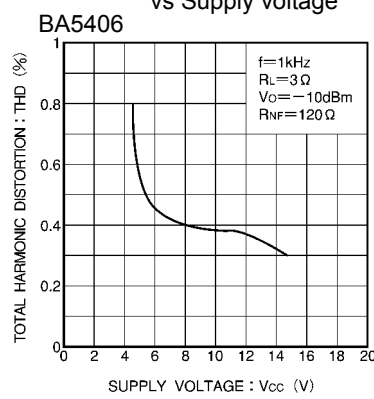

Fig.12 Distortion vs power supply voltage

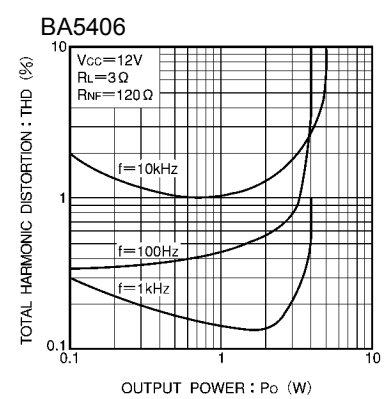

Fig.13 Distortion vs Output power

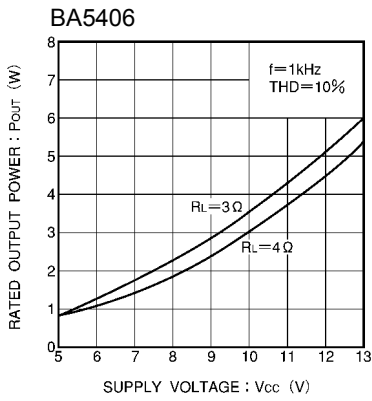

Fig.14 Output power vs power supply voltage

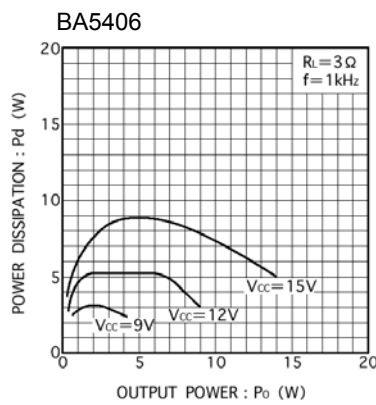

Fig.15 Power dissipation vs Output power(1)

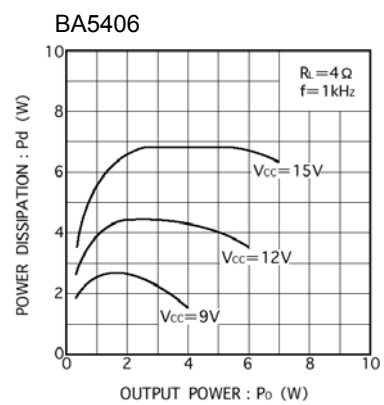

Fig.16 Power dissipation vs Output power(2)

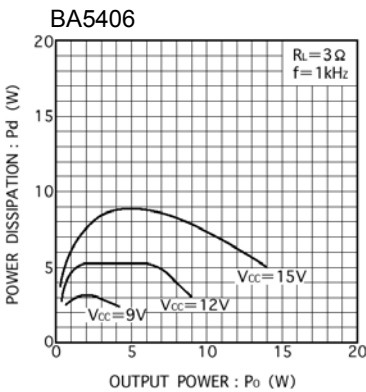

Fig.17 Power dissipation vs Output power(3)

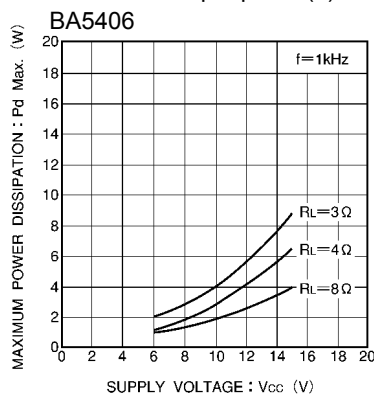

Fig.18 Maximum power dissipation vs Supply voltage

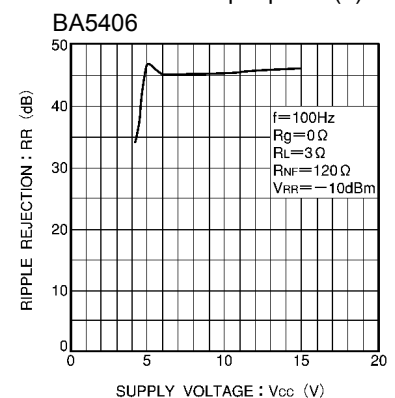

Fig.19 Ripple rejection ratio vs Supply voltage

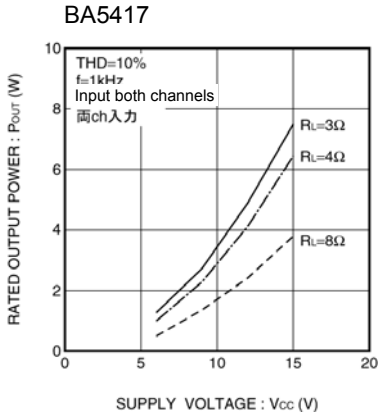

Fig.20 Rated output power vs Supply voltage

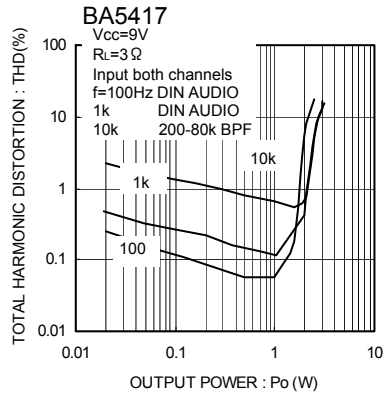

Fig.21 Total harmonic distortion vs Output power

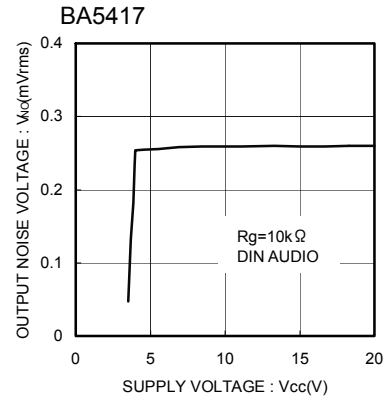

Fig.22 Output noise voltage vs Supply voltage

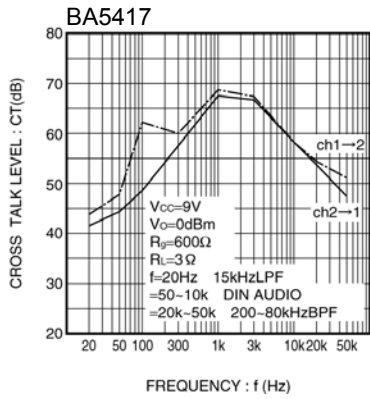

Fig.23 Crosstalk vs. Frequency

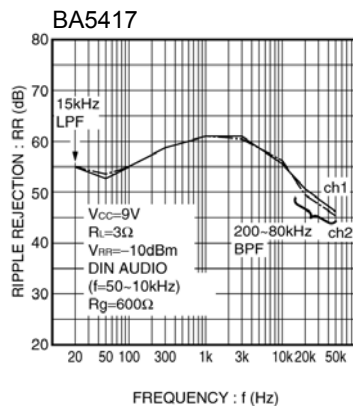

Fig.24 Ripple rejection vs. Frequency

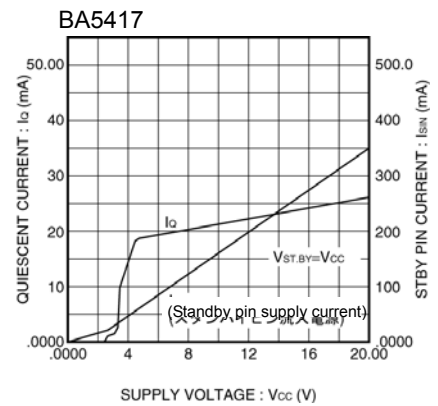

Fig.25 Quiescent, standby pin input current vs. Supply voltage

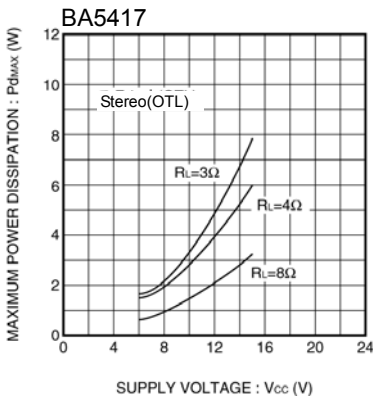

Fig.26 Maximum power dissipation vs. Supply voltage

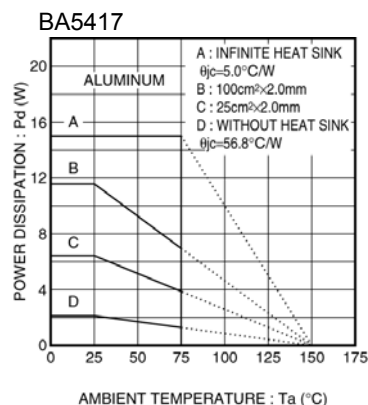

Fig.27 Thermal derating curve

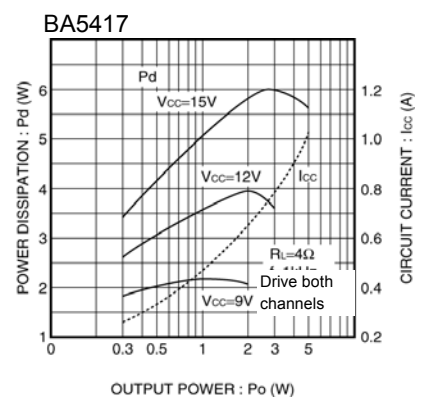

Fig.28 Power dissipation, circuit current vs. Supply Voltage (RL=4Ω)

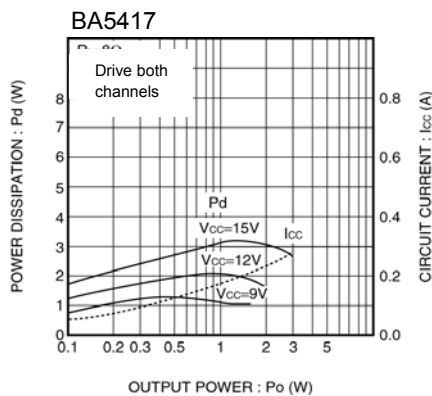

Fig.29 Power dissipation, circuit current vs. Supply Voltage (RL=8Ω)

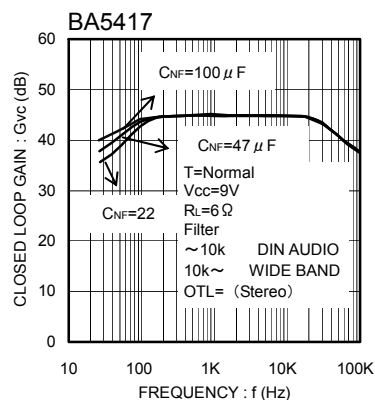

Fig.30 Closed loop gain vs. Frequency

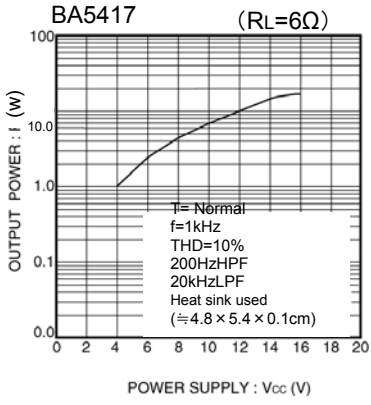

Fig.31 Rated output power vs. Supply Voltage

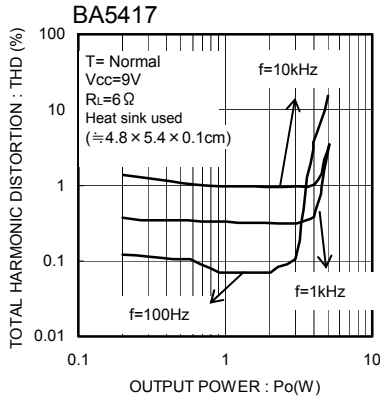

Fig.32 Total harmonic distortion vs. Output power

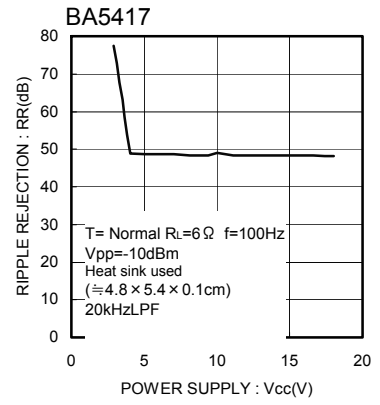

Fig.33 Ripple rejection ratio vs. Supply Voltage

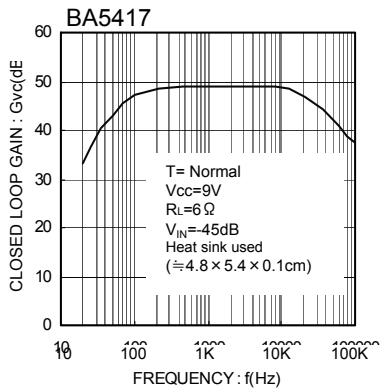

Fig.34 Close loop gain vs. Frequency

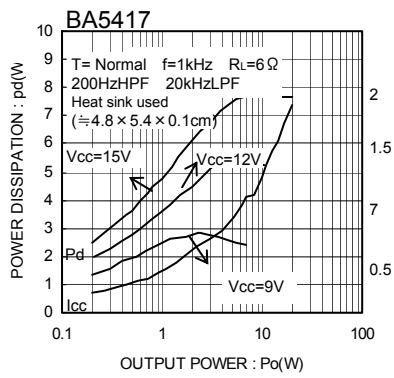

Fig.35 Power dissipation, Supply current vs. Frequency

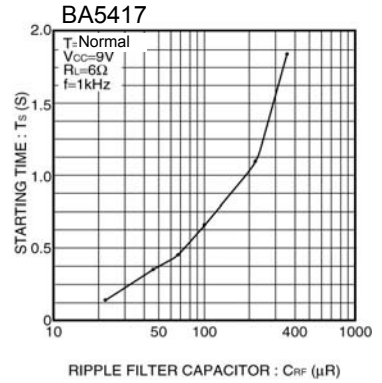

Fig.36 Starting time vs. Ripple filter capacitor

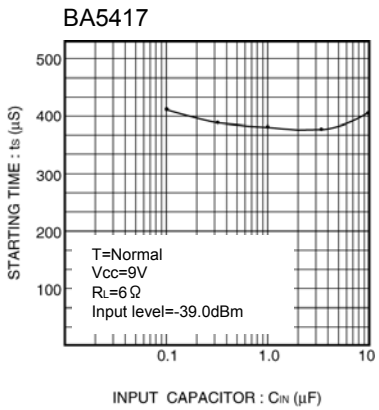

Fig.37 Starting time vs. Input coupling capacitor

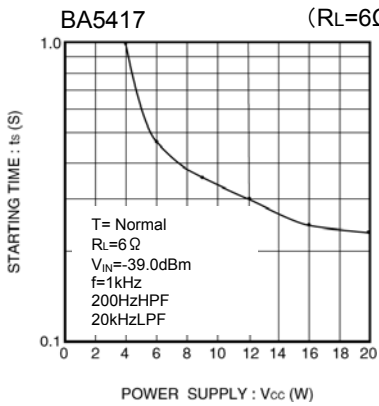

Fig.38 Starting time vs. Supply Voltage

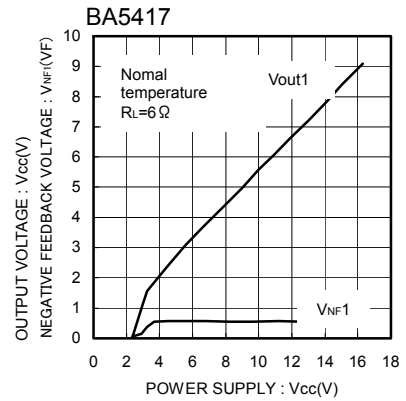

Fig.39 Output voltage, Negative feedback voltage vs. Supply Voltage

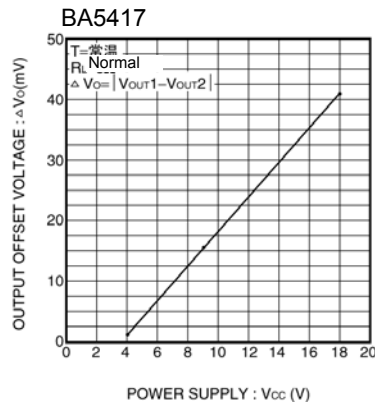

Fig.40 Output offset voltage vs. Supply Voltage

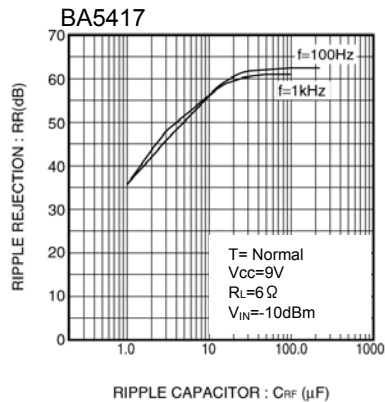
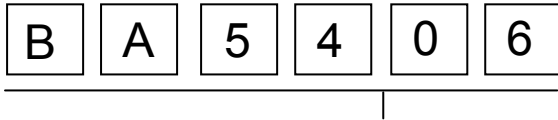

Fig.41 Ripple rejection vs. Ripple filter capacitor

● Selection of order type



Part No.
BA5406
BA5417

SIP-M12

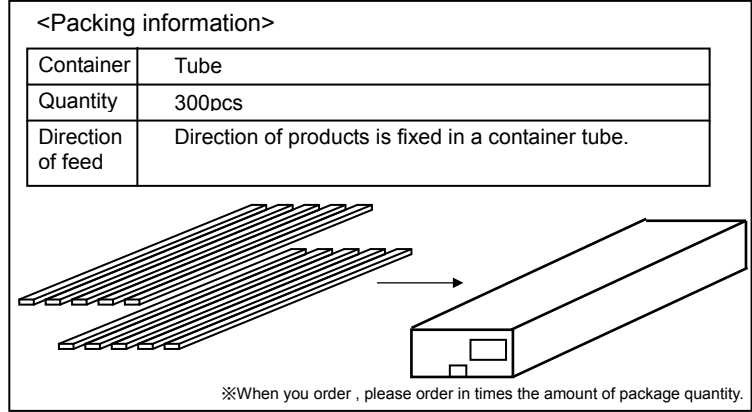
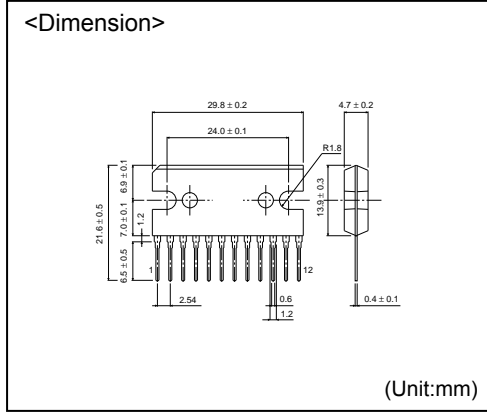

HSIP15

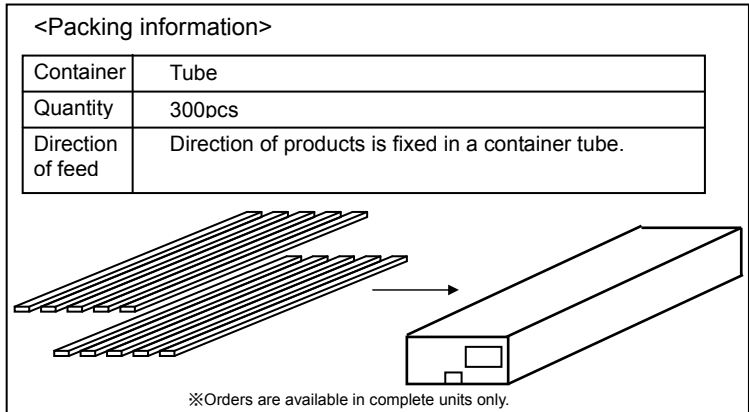
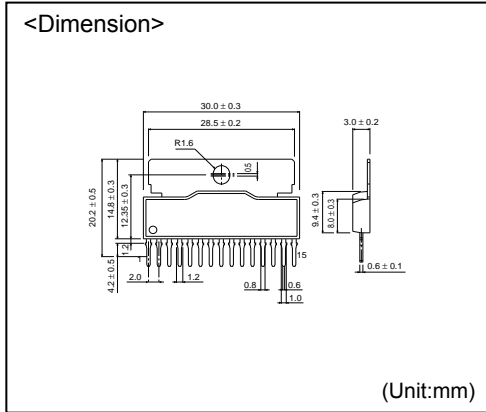

- The contents described herein are correct as of October, 2005
- The contents described herein are subject to change without notice. For updates of the latest information, please contact and confirm with ROHM CO.,LTD.
- Any part of this application note must not be duplicated or copied without our permission.
- Application circuit diagrams and circuit constants contained herein are shown as examples of standard use and operation. Please pay careful attention to the peripheral conditions when designing circuits and deciding upon circuit constants in the set.
- Any data, including, but not limited to application circuit diagrams and information, described herein are intended only as illustrations of such devices and not as the specifications for such devices. ROHM CO.,LTD. disclaims any warranty that any use of such devices shall be free from infringement of any third party's intellectual property rights or other proprietary rights, and further, assumes no liability of whatsoever nature in the event of any such infringement, or arising from or connected with or related to the use of such devices.
- Upon the sale of any such devices, other than for buyer's right to use such devices itself, resell or otherwise dispose of the same, implied right or license to practice or commercially exploit any intellectual property rights or other proprietary rights owned or controlled by ROHM CO., LTD. is granted to any such buyer.
- The products described herein utilize silicon as the main material.
- The products described herein are not designed to be X ray proof.

The products listed in this catalog are designed to be used with ordinary electronic equipment or devices (such as audio visual equipment, office-automation equipment, communications devices, electrical appliances and electronic toys). Should you intend to use these products with equipment or devices which require an extremely high level of reliability and the malfunction of which would directly endanger human life (such as medical instruments, transportation equipment, aerospace machinery, nuclear-reactor controllers, fuel controllers and other safety devices), please be sure to consult with our sales representative in advance.

Excellence in Electronics



ROHM CO., LTD.

21, Saiin Mizosaki-cho, Ukyo-ku, Kyoto
615-8585, Japan
TEL: (075)311-2121 FAX: (075)315-0172
URL: <http://www.rohm.com>

Published by
Application Engineering Group

Contact us for further information about the products.

- Atlanta U.S.A. / ROHM ELECTRONICS ATLANTA SALES OFFICE
(DIVISION OF ROHM ELE.U.S.A.,LLC)
TEL: +1(770)754-8372 FAX: +1(770)754-0391
- Dallas U.S.A. / ROHM ELECTRONICS DALLAS SALES OFFICE
(DIVISION OF ROHM ELE.U.S.A.,LLC)
TEL: +1(972)312-8818 FAX: +1(972)312-0330
- San Diego U.S.A. / ROHM ELECTRONICS SAN DIEGO SALES OFFICE
(DIVISION OF ROHM ELE.U.S.A.,LLC)
TEL: +1(858)625-3630 FAX: +1(858)625-3670
- Germany / ROHM ELECTRONICS GMBH (GERMANY)
TEL: +49(2154)9210 FAX: +49(2154)921400
- United Kingdom / ROHM ELECTRONICS GMBH (UK)
TEL: +44(0)1908-306700 FAX: +44(0)1908-235788
- France / ROHM ELECTRONICS GMBH (FRANCE)
TEL: +33(0)1 56 97 30 60 FAX: +33(0)1 56 97 30 80
- Hong Kong China / ROHM ELECTRONICS (H.K.) CO., LTD.
TEL: +852(2)7406262 FAX: +852(2)375-8971
- Shanghai China / ROHM ELECTRONICS (SHANGHAI) CO., LTD.
TEL: +86(21)6279-2727 FAX: +86(21)6247-2066
- Dalian China / ROHM ELECTRONICS TRADING (DALIAN) CO., LTD.
TEL: +86(411)8230-8549 FAX: +86(411)8230-8537

- Beijing China / BEIJING REPRESENTATIVE OFFICE
TEL: +86(10)8525-2483 FAX: +86(10)8525-2489
- Taiwan / ROHM ELECTRONICS TAIWAN CO., LTD.
TEL: +886(2)2500-6956 FAX: +886(2)2503-2869
- Korea / ROHM ELECTRONICS KOREA CORPORATION
TEL: +82(2)8182-7000 FAX: +82(2)8182-715
- Singapore / ROHM ELECTRONICS ASIA PTE. LTD. (RES/REI)
TEL: +65-6332-2322 FAX: +65-6332-6562
- Malaysia / ROHM ELECTRONICS (MALAYSIA) SDN. BHD.
TEL: +60(3)7958-8355 FAX: +60(3)7958-8377
- Philippines / ROHM ELECTRONICS (PHILIPPINES) SALES CORPORATION
TEL: +63(2)807-6872 FAX: +63(2)809-1422
- Thailand / ROHM ELECTRONICS (THAILAND) CO., LTD.
TEL: +66(2)254-4890 FAX: +66(2)256-6334

Notes

- No technical content pages of this document may be reproduced in any form or transmitted by any means without prior permission of ROHM CO.,LTD.
- The contents described herein are subject to change without notice. The specifications for the product described in this document are for reference only. Upon actual use, therefore, please request that specifications to be separately delivered.
- Application circuit diagrams and circuit constants contained herein are shown as examples of standard use and operation. Please pay careful attention to the peripheral conditions when designing circuits and deciding upon circuit constants in the set.
- Any data, including, but not limited to application circuit diagrams information, described herein are intended only as illustrations of such devices and not as the specifications for such devices. ROHM CO.,LTD. disclaims any warranty that any use of such devices shall be free from infringement of any third party's intellectual property rights or other proprietary rights, and further, assumes no liability of whatsoever nature in the event of any such infringement, or arising from or connected with or related to the use of such devices.
- Upon the sale of any such devices, other than for buyer's right to use such devices itself, resell or otherwise dispose of the same, no express or implied right or license to practice or commercially exploit any intellectual property rights or other proprietary rights owned or controlled by
- ROHM CO., LTD. is granted to any such buyer.
- Products listed in this document are no antiradiation design.

The products listed in this document are designed to be used with ordinary electronic equipment or devices (such as audio visual equipment, office-automation equipment, communications devices, electrical appliances and electronic toys).

Should you intend to use these products with equipment or devices which require an extremely high level of reliability and the malfunction of which would directly endanger human life (such as medical instruments, transportation equipment, aerospace machinery, nuclear-reactor controllers, fuel controllers and other safety devices), please be sure to consult with our sales representative in advance.

It is our top priority to supply products with the utmost quality and reliability. However, there is always a chance of failure due to unexpected factors. Therefore, please take into account the derating characteristics and allow for sufficient safety features, such as extra margin, anti-flammability, and fail-safe measures when designing in order to prevent possible accidents that may result in bodily harm or fire caused by component failure. ROHM cannot be held responsible for any damages arising from the use of the products under conditions out of the range of the specifications or due to non-compliance with the NOTES specified in this catalog.

Thank you for your accessing to ROHM product informations.

More detail product informations and catalogs are available, please contact your nearest sales office.

ROHM Customer Support System

THE AMERICAS / EUROPE / ASIA / JAPAN

www.rohm.com

Contact us : webmaster@rohm.co.jp