

BYW54

SINTERED GLASS JUNCTION GENERAL AVALANCHE RECTIFIER

VOLTAGE: 600V

CURRENT: 2.0A



FEATURE

Glass passivated
High maximum operating temperature
Low leakage current
Excellent stability
Guaranteed avalanche energy absorption capability

MECHANICAL DATA

Case: SOD-57 sintered glass case
Terminal: Plated axial leads solderable per MIL-STD 202E, method 208C
Polarity: color band denotes cathode end
Mounting position: any

SOD-57

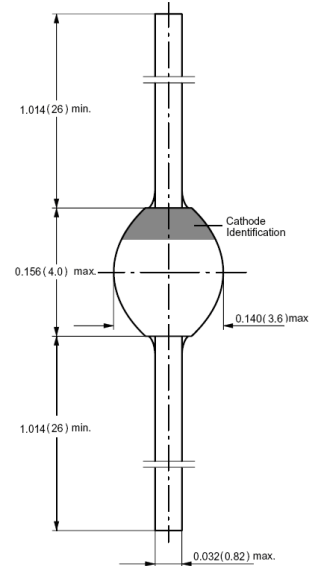

Dimensions in inches and (millimeters)

MAXIMUM RATINGS AND ELECTRICAL CHARACTERISTICS

(single-phase, half-wave, 60HZ, resistive or inductive load rating at 25°C, unless otherwise stated)

	SYMBOL	BYW54	units
Maximum Recurrent Peak Reverse Voltage	V_{RRM}	600	V
Maximum RMS Voltage	V_{RMS}	420	V
Maximum DC blocking Voltage	V_{DC}	600	V
Maximum Average Forward Rectified Current 3/8" lead length at $T_{tp}=45^{\circ}C$	I_{FAV}	2.0	A
Peak Forward Surge Current at $T_p=10ms$ half sine wave	I_{FSM}	50	A
Maximum Forward Voltage at Forward Current 1A	V_F	1.00	V
Non-repetitive peak reverse avalanche energy at $I_{(BR)R}=1A$	E_R	20	mJ
Maximum DC Reverse Current $T_a = 25^{\circ}C$ at rated DC blocking voltage $T_a = 100^{\circ}C$	I_R	1.0 10.0	μA
Typical Reverse Recovery Time (Note 1)	T_{rr}	3.0	μS
Typical Thermal Resistance (Note 2)	$R_{th(ja)}$	46	KW
Storage and Operating Junction Temperature	T_{stg}, T_j	-65 to +175	$^{\circ}C$

Note:

1. Reverse Recovery Condition $I_f = 0.5A, I_r = 1.0A, I_{rr} = 0.25A$
2. $l = 10mm, T_L = \text{constant}$

RATINGS AND CHARACTERISTIC CURVES BYW54

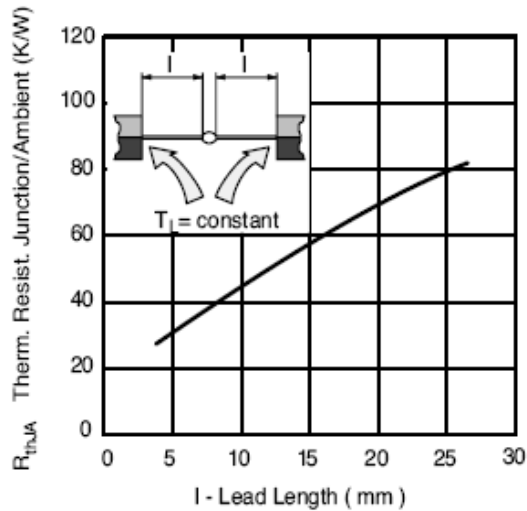

Figure 1. Typ. Thermal Resistance vs. Lead Length

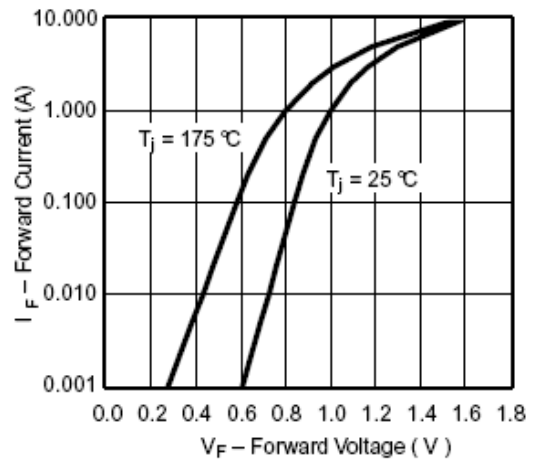

Figure 2. Forward Current vs. Forward Voltage

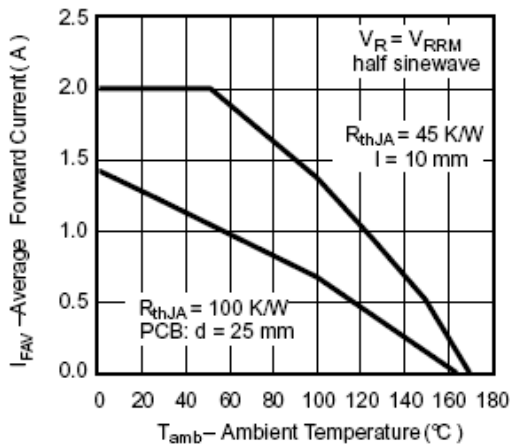

Figure 3. Max. Average Forward Current vs. Ambient Temperature

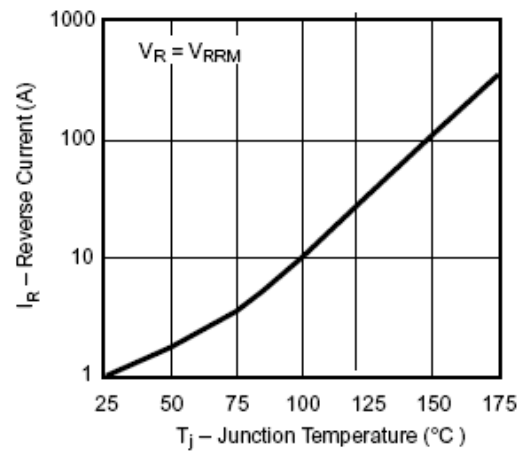

Figure 4. Reverse Current vs. Junction Temperature

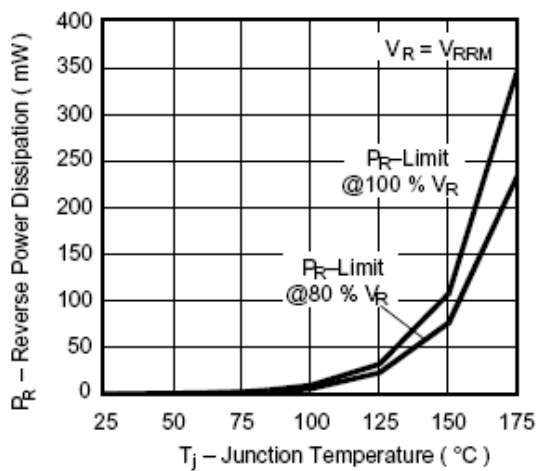

Figure 5. Max. Reverse Power Dissipation vs. Junction Temperature

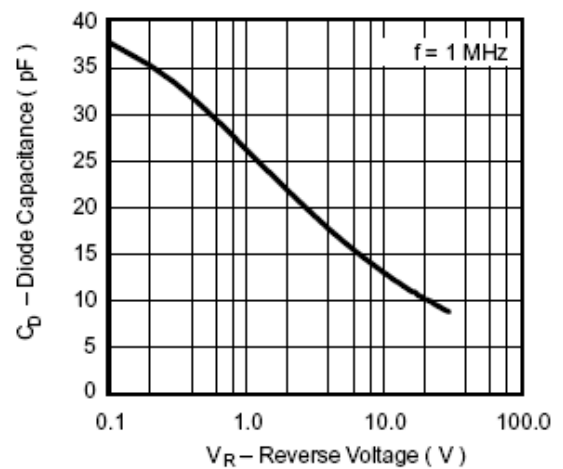

Figure 6. Diode Capacitance vs. Reverse Voltage