

# SIRIUS DC/DC CONVERTER

## 48V Input – 9.6VDC – 47A Output



GALW9V647

### GALW9V647 – 1/4 Brick Sirius

- High efficiency: 93.5% at 9.6V, 47A  
94.5% at 9.6V, 23.5A
- Very low common-mode noise for a commercial DC/DC converter
- Two-stage input filter
- Constant switching frequency
- Single board design, very low parts count
- “Stretched” quarter-brick 1.45" x 4.25" x 0.95" including integrated heat sink

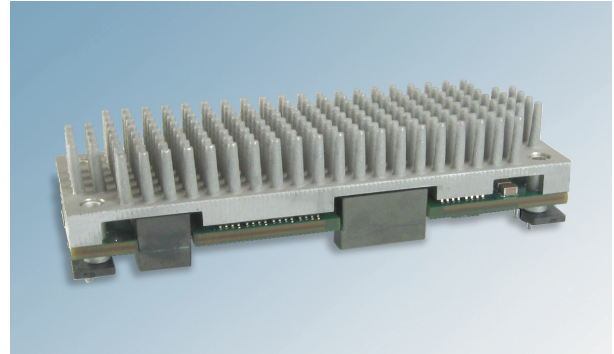

### Typical Characteristics

- Output setpoint accuracy:  $\pm 5\%$
- Load regulation:  $\pm 2\%$
- Line regulation:  $\pm 0.2\%$
- Regulation over line, load, and temperature:  $\pm 10\%$
- Low output ripple
- Output trim

### Control Functions

- Uses patented power supply control and architecture
- Microprocessor controlled
- Primary-side enable, choice of logic

### Protection Features

- Over temperature protection
- Over voltage protection
- Over current protection
- Over/Under input voltage protection

### Ordering Information

Standard Model Number	Input Voltage	Output Voltage	Max Current
GALW9V647*	48V	9.6V	47A

\* **Options:**  
E = 0.18" Pins ( $\pm .01"$ )

Note: Standard unit is positive logic and requires 2000 $\mu$ F of output load capacitance for stability.

**Example Part Number:**  
(All options)

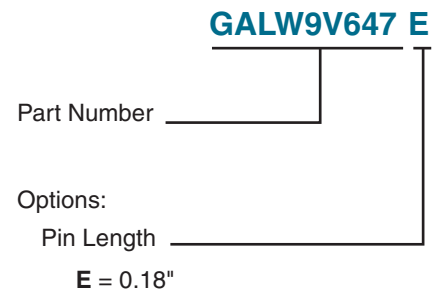

Certified to ISO 9001:2000

©2008 Bel Fuse Inc. Specifications subject to change without notice. 07.08

GALW9V647

### Input Specifications

Parameter	Min	Typical	Max	Units
Operating Input Voltage	36		75	V <sub>DC</sub>
Input Current, Low Line			13.5	A
Input Capacitance		8		μF
Input Hysteresis, Low Line		2		V <sub>DC</sub>

V<sub>IN</sub> = 48V<sub>DC</sub>, T<sub>A</sub>@25° C, 300 LFM Airflow, V<sub>OUT</sub> = 9.6V<sub>DC</sub>, I<sub>OUT</sub> = Full load unless otherwise noted.  
 Available output power depends on ambient temperature and good thermal management.  
 (See application graphs for limits.)

### Output Specifications

Parameter	Min	Typical	Max	Units
Output Voltage	9.2	9.6	10	V
Output Power			450	W
Over Voltage Protection, Latching	11.04	11.52	12.48	V
Operating Output Current Range	0		47	A
Output Current Limit	50		65	A
Efficiency, Full Load <sup>1</sup>	93			%

1. For temperature rise design calculation.

# SIRIUS DC/DC CONVERTER

48V Input – 9.6VDC – 47A Output



GALW9V647

## Features

Parameter	Min	Typical	Max	Units
Over Temperature Protection, Thermal Sensor, Latching <sup>2</sup>			125	° C
Switching Frequency, Fixed		250		kHz
Trim Range	8.64		10.56	V

2. PCB less than 130° C.

## General Specifications

Operating Temperature	-40° C to + 100° C
Storage Temperature	-55° C + 125° C
Relative Humidity	10% to 95% RH, Non-condensing
Vibration	2 to 9 Hz, 3mm disp., 9 to 200 Hz, 1g
Material Flammability	UL V-0
Weight	TBD
MTBF Telcordia (Bellcore)	TBD

**Application Notes**

**CoolConverter™**

**Bel Power’s Proprietary CoolConverter™**

- Patented single-stage power conversion architecture, control and magnetic design allow unprecedented power density and efficiency in an isolated power supply.
- An advanced microcontroller reduces parts count while adding features, performance and flexibility in the design.

**Protection and Control**

**Valid Input Voltage Range**

The converter measures the input voltage and will not allow operation outside of the input voltage specification. As shown by the graphs, hysteresis is added to both the high and low voltage to prevent the converter from turning on and off repeatedly when the voltage is held near either voltage extreme. At low line, this assures the maximum input current is not exceeded; at high line, this assures the semiconductor devices in the converter are not damaged by excessive voltage stress.

**ON/OFF Logic Option**

The ON/OFF control logic can be either Negative (standard) or Positive to enable the converter. For Negative logic, the ON/OFF pin is brought to below 1.0V with respect to the –INPUT pin to enable the converter. The pull-down must be able to sink 100µA. For Positive logic, the ON/OFF pin is brought to greater than 4.0V with respect to the –INPUT pin and be limited to less than 10V. To request the Positive logic version, add the suffix (P) to the standard part number. The ON/OFF pin has a built-in pull-up resistor of approximately 100k to +5V.

**Output Over Voltage Protection**

The output voltage is constantly monitored by the microprocessor with a redundant secondary-side measurement circuit that both shuts down the duty cycle and triggers the microprocessor to shut down. If the output voltage exceeds the over voltage specification, the microprocessor will latch the converter off. To turn the converter on required either cycling the ON/OFF pin or power to the converter. This advanced feature prevents the converter from damaging the load if there is a converter failure or application error. If non-latching is required, consult factory.

Over Voltage Hysteresis

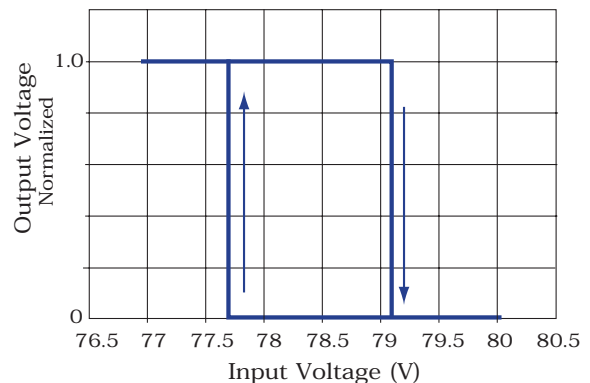

Under Voltage Hysteresis

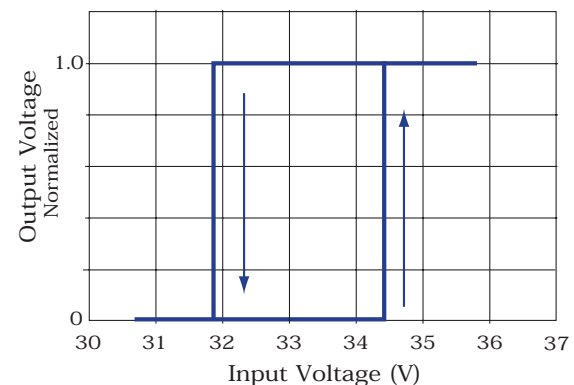

# SIRIUS DC/DC CONVERTER

## 48V Input – 9.6VDC – 47A Output



GALW9V647

### CoolConverter™

#### Protection and Control

##### Thermal Shutdown

The printed circuit board temperature is measured using a semiconductor sensor. If the maximum rated temperature is exceeded, the converter is latched off. To re-enable the converter requires cycling the ON/OFF pin or power to the converter. If non-latching is required, consult factory.

##### Control Options

As the behavior of the circuit is determined by firmware in the microcontroller, specific requirements, such as:

- non-latching thermal protection
- custom valid input voltage range
- controlled delay from initiating an ON/OFF signal for power sequencing

can be accomplished with no change to hardware. The standard behavior was chosen based on system design experience, but customers may have their own requirements. Please contact Bel Power for any special needs.

##### Safety

An external input fuse must always be used to meet these safety requirements.

#### External Output Trimming

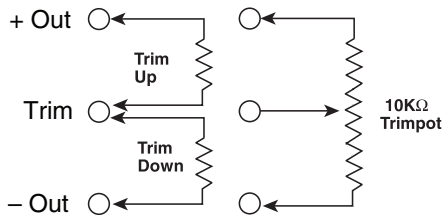

##### Trim

To trim the output voltage higher, connect the required trim resistor from the Trim pin to the +Out pin. To trim the output voltage lower, connect the required trim resistor from the Trim pin to the -Out pin.

#### Trim-up

$$R_{\text{TRIM-UP}} = \left\{ \frac{V_o (100+\Delta\%)}{1.225\Delta\%} - \frac{(100+2\Delta\%)}{\Delta\%} \right\} 5.11k$$



#### Trim-down

$$R_{\text{TRIM-DOWN}} = \left\{ \frac{100}{\Delta\%} - 2 \right\} 5.11k$$

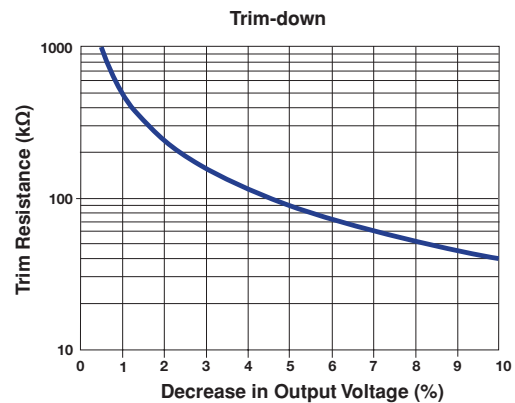

GALW9V647

### Efficiency Data

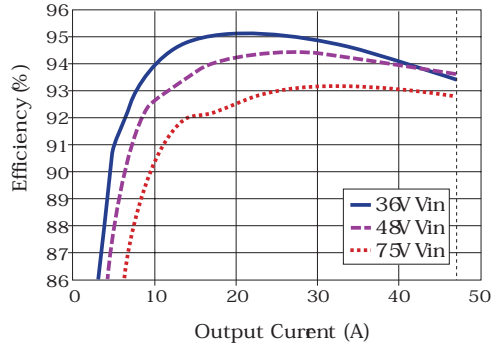

### Power Dissipation

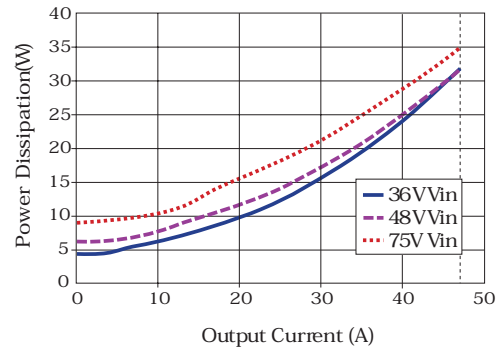

### Start Up

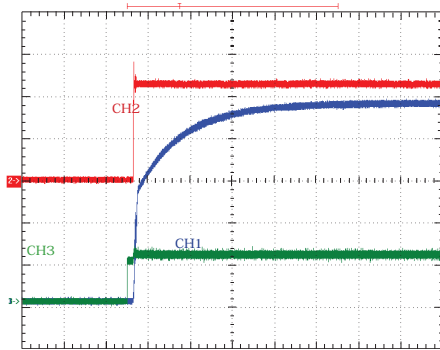

1.  $V_{OUT}$  2V 10mS/div
2.  $I_{OUT}$  10A/div
3. Enable 5V/div

### Voltage Ripple

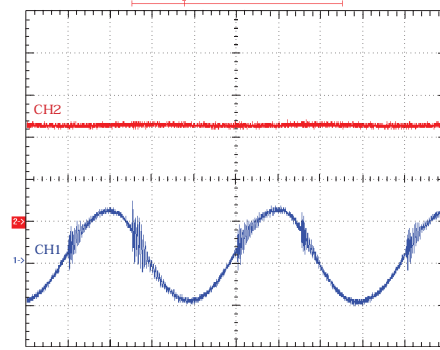

1.  $V_{OUT}$  50mV/div 1 $\mu$ S/div  
10 $\mu$ F ext cap 20MHz BW
2.  $I_{OUT}$  10A/div

### Line/Load Regulation

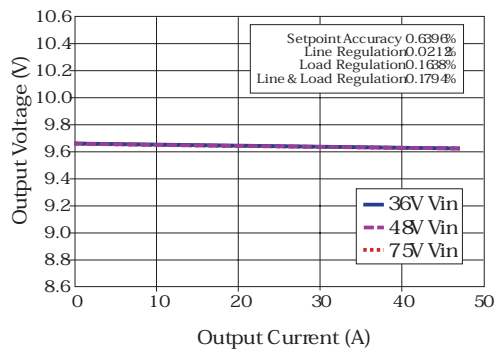

Setpoint Accuracy 0.6396%  
Line Regulation 0.0212%  
Load Regulation 0.1638%  
Line & Load Regulation 0.1794%

### Transient Response

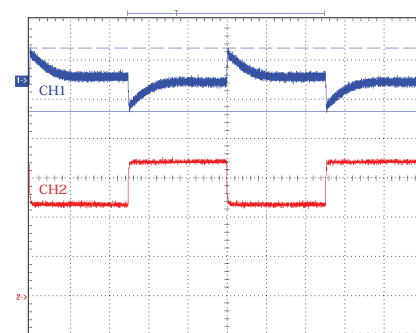

1.  $V_{OUT}$  500mV/div 400 $\mu$ S/div
2.  $I_{OUT}$  10A/div

# SIRIUS DC/DC CONVERTER

48V Input – 9.6VDC – 47A Output



GALW9V647

## Back Bias

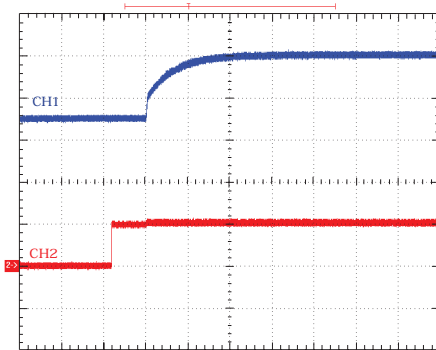

1.  $V_{OUT}$  2V/div 10mS/div  
2. Enable 5V/div

## Over Current Protection

Note: Over current protection is blip-mode (aka hiccup).

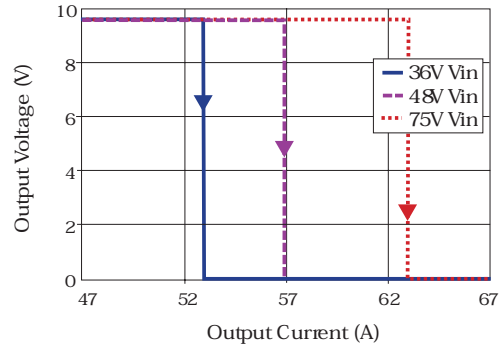

## Over Voltage Protection

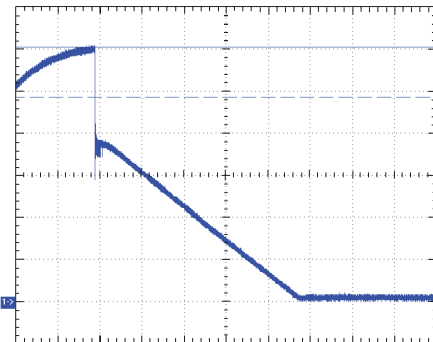

1.  $V_{OUT}$  2V/div 4mS/div

## Thermal Derating

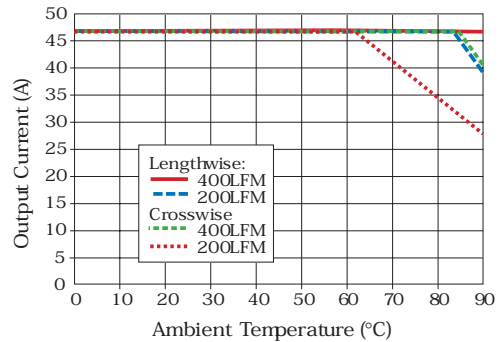

# SIRIUS DC/DC CONVERTER

48V Input – 9.6VDC – 47A Output



GALW9V647

## Mechanical

GALW9V647

HEAT SINK INFORMATION:  
PIN FINS MAY BE CHANGED FOR  
CUSTOM APPLICATIONS.

1. PIN FIN AREA = .105" sq
2. PIN FIN COUNT = 176
3. TOTAL PIN FIN AREA= 18.5"sq
4. PIN FIN DENSITY= 50% OF HS AREA

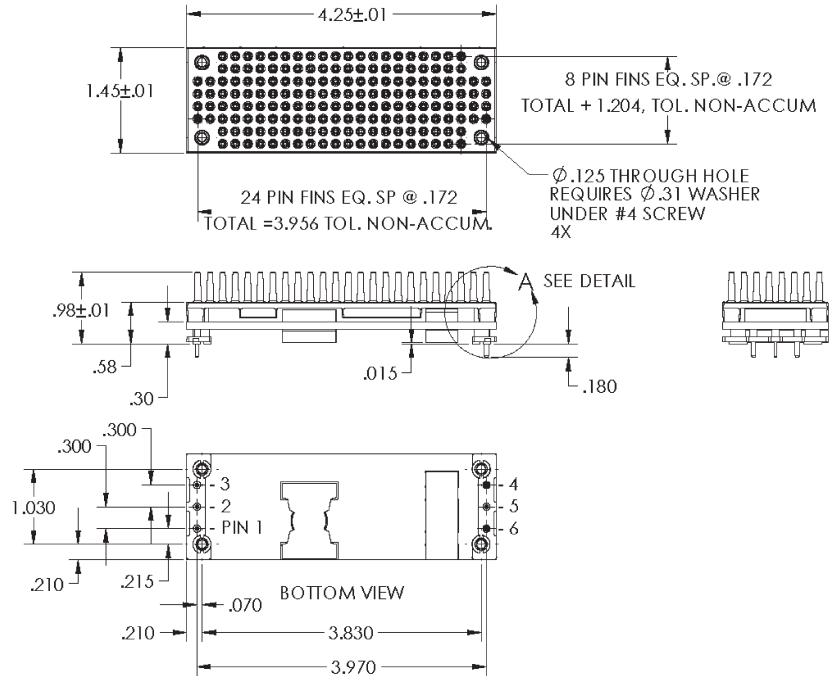
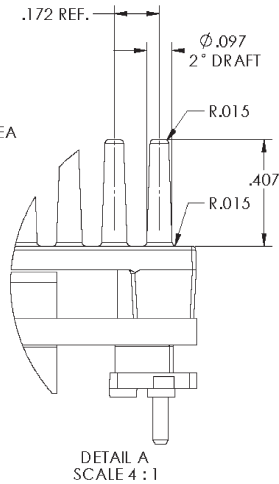

## Pin Configuration – Bottom View

Pin	Function	Pin Dia. (In.)
1	+ Input	0.040
2	On/Off	0.040
3	- Input	0.040
4	- Output	0.060
5	Trim	0.040
6	+ Output	0.060

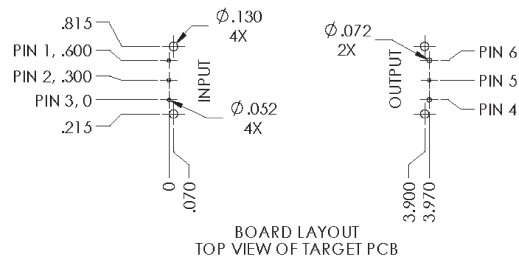

NOTE:  
1. HOLE SIZE IS GIVEN AS A REF. ONLY.

©2008 Bel Fuse Inc. Specifications subject to change without notice. 07.08

### CORPORATE

Bel Fuse Inc.  
206 Van Vorst Street  
Jersey City, NJ 07302  
Tel 201-432-0463  
Fax 201-432-9542  
www.belfuse.com

### FAR EAST

Bel Fuse Ltd.  
8F / 8 Luk Hop Street  
San Po Kong  
Kowloon, Hong Kong  
Tel 852-2328-5515  
Fax 852-2352-3706  
www.belfuse.com

### EUROPE

Bel Fuse Europe Ltd.  
Preston Technology Management Centre  
Marsh Lane, Suite G7, Preston  
Lancashire, PR1 8UQ, U.K.  
Tel 44-1772-556601  
Fax 44-1772-888366  
www.belfuse.com