



CHENMKO ENTERPRISE CO.,LTD

**S16S30PT
THRU
S16S45PT**

Lead free devices

SCHOTTKY BARRIER RECTIFIER

VOLTAGE RANGE 30 - 45 Volts CURRENT 16 Amperes

FEATURES

- * Plastic package has Underwriters Laboratory Flammability Classification 94V-0
- * Metal Silicon junction, majority carrier conduction
- * Low power loss,high efficiency
- * High current capability, low forward voltage drop
- * Guardring for overvoltage protection
- * For use in low voltage, high frequency inverters, free wheeling, and polarity protection applications
- * High temperature soldering in accordance with CECC 802 / Reflow guaranteed

MECHANICAL DATA

Case: JEDEC D2PAK molded plastic
Terminals: Lead solderable per MIL-STD-750, Method 2026
Polarity: As marked
Weight: 0.08 ounces, 2.24 grams

MAXIMUM RATINGS AND ELECTRICAL CHARACTERISTICS

Ratings at 25°C ambient temperature unless otherwise specified.
 Single phase, half wave, 60 Hz, resistive or inductive load.
 For capacitive load, derate current by 20%.

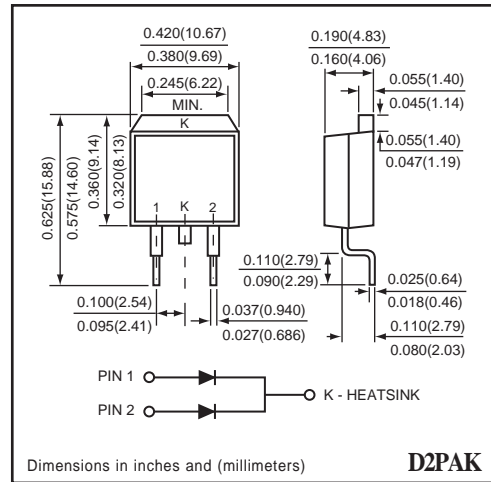
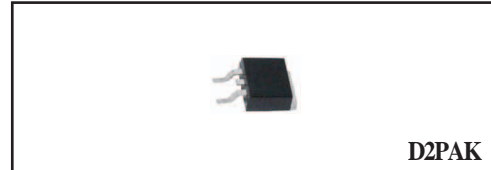

MAXIMUM RATINGS (At TA = 25°C unless otherwise noted)

RATINGS	SYMBOL	S16S30PT	S16S35PT	S16S40PT	S16S45PT	UNITS
Maximum Recurrent Peak Reverse Voltage	V _{RRM}	30	35	40	45	Volts
Maximum RMS Voltage	V _{RMS}	21	24	28	31	Volts
Maximum DC Blocking Voltage	V _{DC}	30	35	40	45	Volts
Maximum Average Forward Rectified Current	I _O	16.0				Amps
Peak Forward Surge Current 8.3 ms single half sine-wave superimposed on rated load (JEDEC method)	I _{FSM}	150				Amps
Typical thermal resistance per leg (NOTE 1)	R _{θJC}	2.0				°C / W
Operating and Storage Temperature Range	T _J , T _{STG}	-40 to +125				°C

ELECTRICAL CHARACTERISTICS (At TA = 25°C unless otherwise noted)

CHARACTERISTICS	SYMBOL	S16S30PT	S16S35PT	S16S40PT	S16S45PT	UNITS
Maximum Instantaneous Forward Voltage at 8.0 A DC	V _F	0.55				Volts
Maximum instantaneous reverse current at rated DC blocking voltage per leg (NOTE 2)	T _C = 25°C	1.0				mAmps
	T _C = 100°C	50				mAmps

NOTES : 1. Thermal resistance from junction to case per leg
 2. Pulse test : 300 us pulse width, 1% duty cycle

RATING CHARACTERISTIC CURVES (S16S30PT THRU S16S45PT)

FIG. 1 - TYPICAL FORWARD CURRENT DERATING CURVE

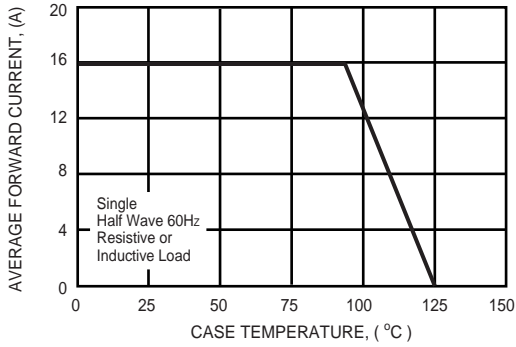

FIG. 2 - MAXIMUM NON-REPETITIVE FORWARD SURGE CURRENT

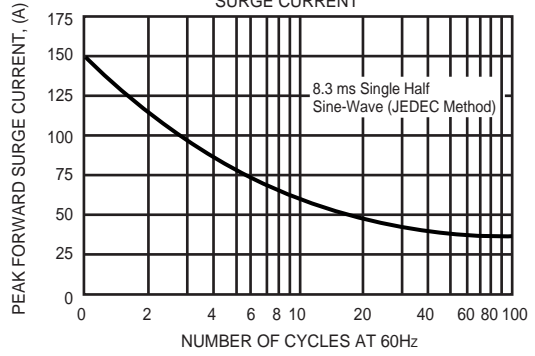

FIG. 3 - TYPICAL INSTANTANEOUS FORWARD CHARACTERISTICS

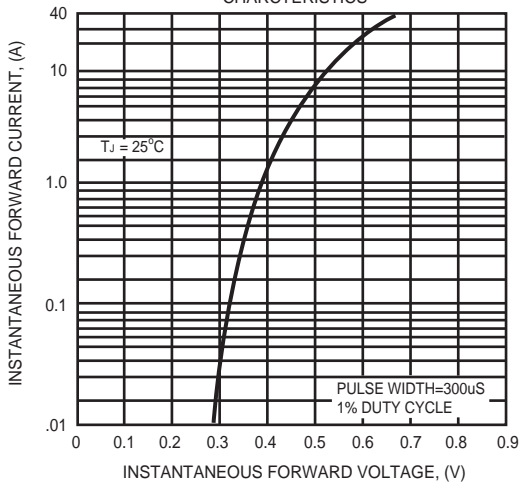

FIG. 4 - TYPICAL REVERSE CHARACTERISTICS

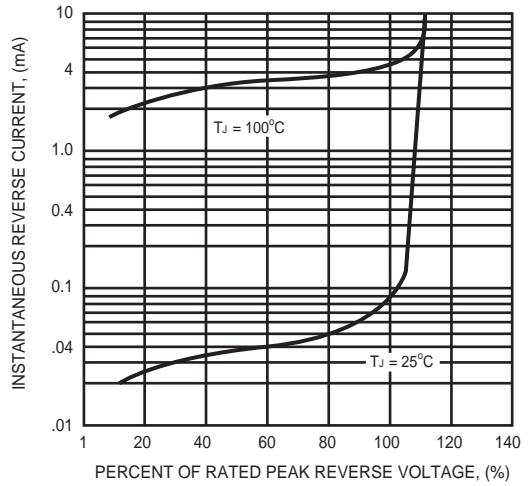

FIG. 5 - TYPICAL JUNCTION CAPACITANCE

