



TAI-SAW TECHNOLOGY CO., LTD.

No. 3, Industrial 2nd Rd., Ping-Chen Industrial District,
Taoyuan, 324, Taiwan, R.O.C.

TEL: 886-3-4690038 FAX: 886-3-4697532

E-mail: tstsales@mail.taisaw.com Web: www.taisaw.com

Approval Sheet For Product Specification

Issued Date:

Product Name: SAW Filter 808MHz SMD 3.8×3.8mm

TST Parts No.:TA0451A

Customer Parts No.:_____

Company: _____
Division: _____
Approved by : _____
Date: _____

Checked by: _____ Elvis Chiu

Approval by: _____ Francis Chen

Date: _____ 2005/05/02



TAI-SAW TECHNOLOGY CO., LTD.

No. 3, Industrial 2nd Rd., Ping-Chen Industrial District,
Taoyuan, 324, Taiwan, R.O.C.

TEL: 886-3-4690038 FAX: 886-3-4697532

E-mail: tstsales@mail.taisaw.com Web: www.taisaw.com

SAW Filter 808 MHz

MODEL NO.: TA0451A

REV. NO.:1

A. MAXIMUM RATING:

1. Input Power Level: 15 dB_m
2. DC voltage: 5 V
3. Operating Temperature: -10°C to 60°C
4. Storage Temperature: -40°C to +85°C

RoHS Compliant
Lead free
Lead-free soldering

B. CHARACTERISTICS:

Item				Min.	Typ.	Max.
Center frequency	Fc	MHz		-	808	-
Insertion loss	806 ~ 810 MHz	IL	dB	-	2.6	4.2
Amplitude ripple	806 ~ 810 MHz		dB	-	0.3	2.0
VSWR	806 ~ 810 MHz			-	1.4	2.2
Attenuation						
	10.0 ~ 735.0	MHz	dB	40	60	-
	735.0 ~ 768.0	MHz	dB	35	57	-
	843.0 ~ 865.0	MHz	dB	35	53	-
	865.0 ~ 885.0	MHz	dB	37	55	-
	885.0 ~ 1000.0	MHz	dB	40	55	-
Source impedance	Zs		Ω	-	50	-
Load impedance	ZL		Ω	-	50	-

Note1. No matching network required for operation at 50Ω

C. TRANSFER FUNCTION:

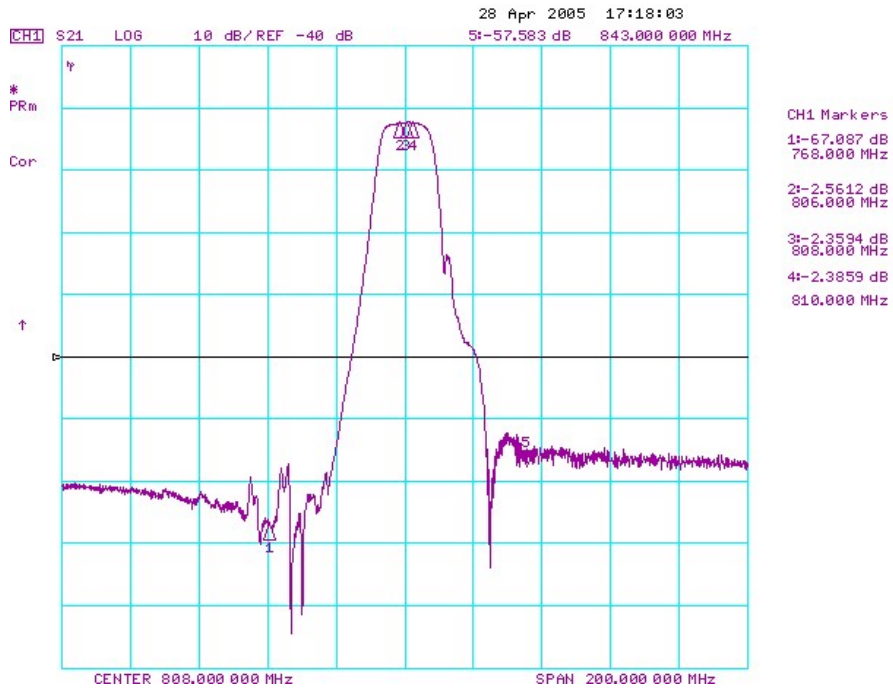

Wideband

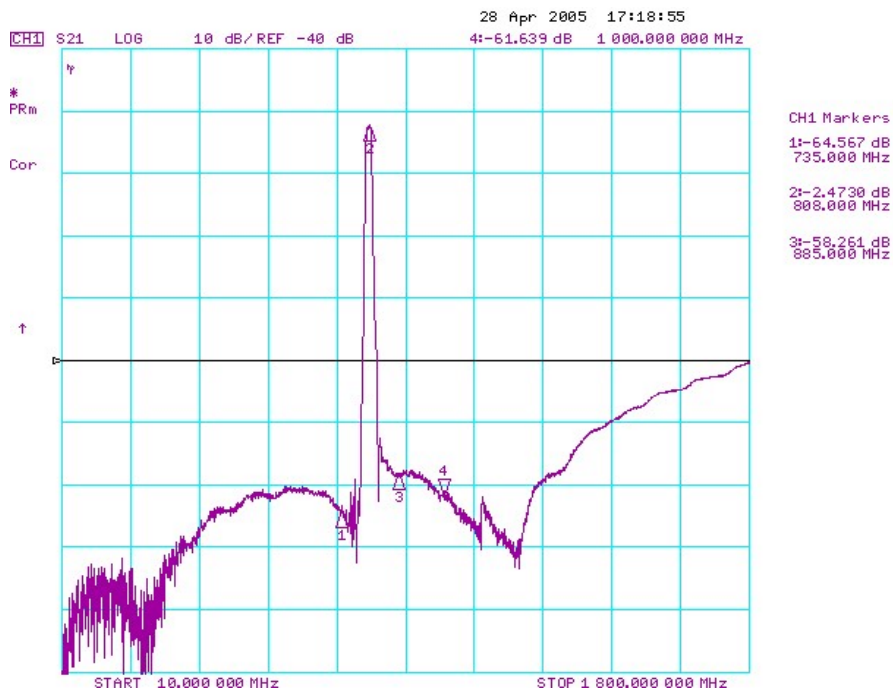

D. REFLECTION FUNCTIONS:

S11

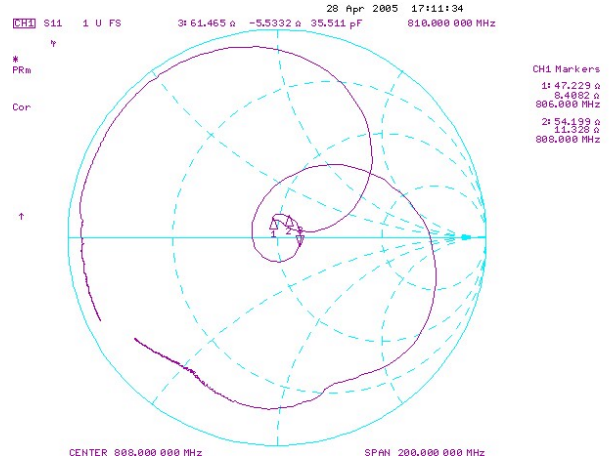
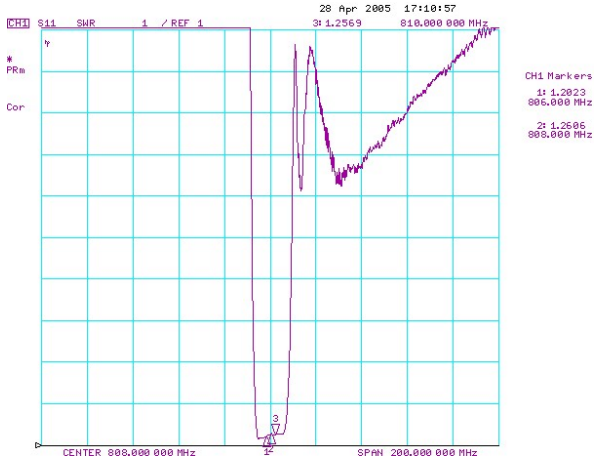

S22

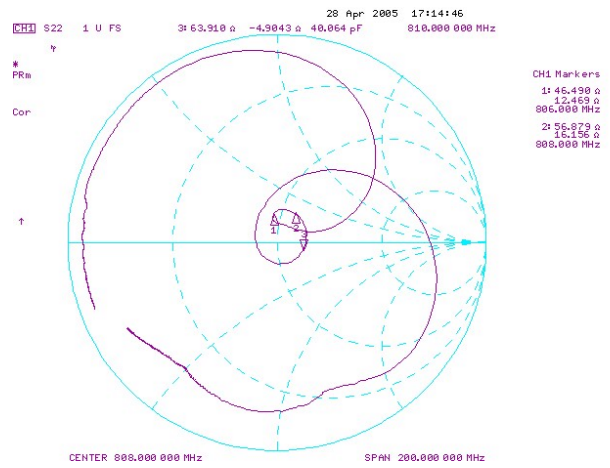
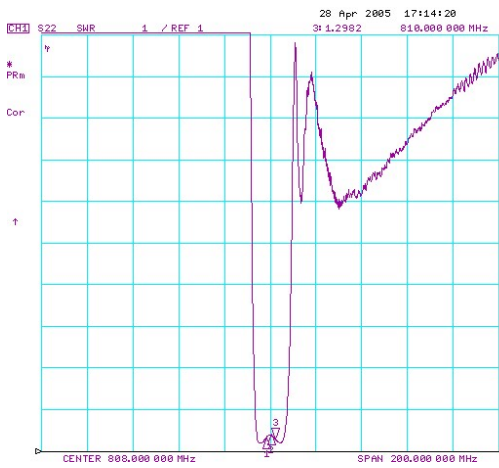

E. MEASUREMENT CIRCUIT:

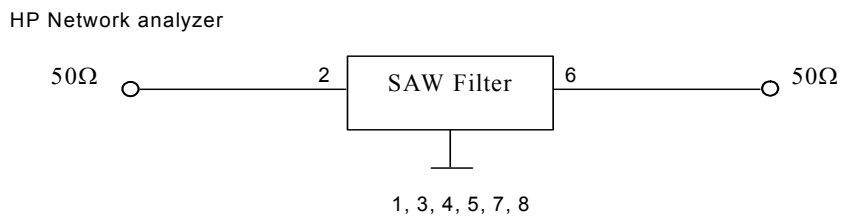

F.OUTLINE DRAWING:

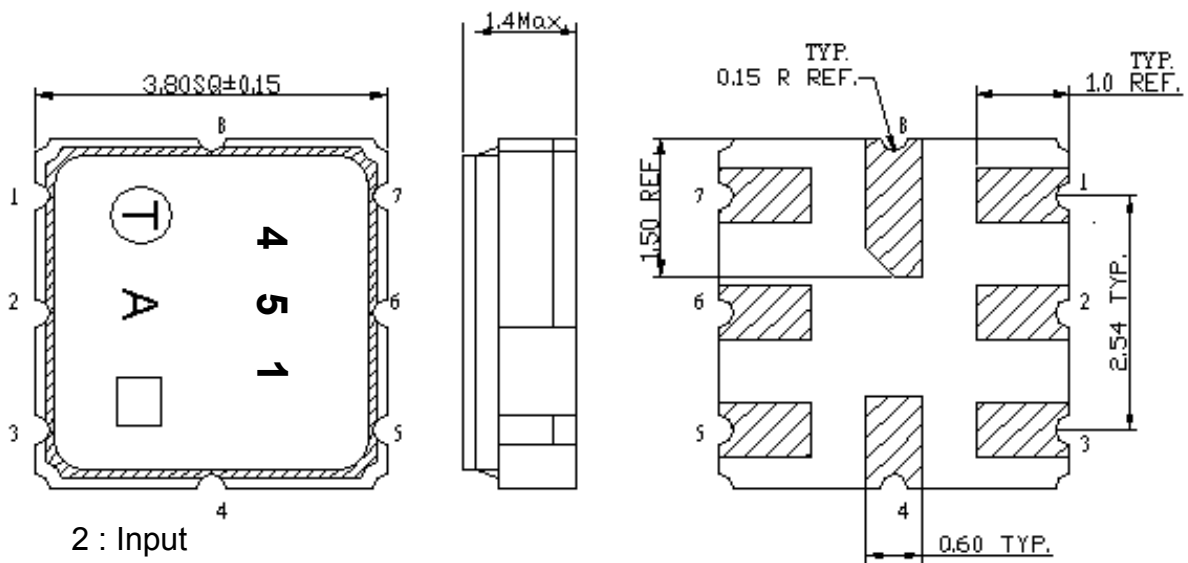

- 2 : Input
- 6: Output
- 1,3,4,5,7,8: Ground
- : Date Code
- Unit: mm

G.PCB FOOTPRINT:

