



# Aluminum electrolytic capacitors

Capacitors for pulse applications

**Series/Type:** B43415, B43416

**Date:** November 2008

**Application**

- Professional flash light generators

**Features**

- Compact design
- Outstanding reliability
- High charge/discharge proof, polar
- Low leakage current
- Low dissipation factor
- RoHS-compatible

**Construction**

- Aluminum case, fully insulated
- Safety vent

**Terminals**

- Snap-in
- Solder lug

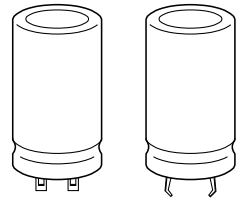
**B43415**
**B43416**
**Overview**

Temperature °C	Series	Useful life	$V_R$ V DC	$C_R$ μF
+60 (max. case temp.)	B43415 Solder lug	> 50000 discharges	300 ... 500	1000 ... 6600
	B43416 Snap-in			200 ... 1500

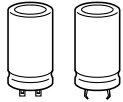
**Specifications and characteristics in brief**

Rated voltage	$V_R$	300 ... 500 V DC	
Rated capacitance	$C_R$	200 ... 6600 $\mu$ F	
Capacitance tolerance	$\Delta C_R$	-10/+20%	
Leakage current (5 min, 20 °C)	$I_{leak}$	$I_{leak} \leq 0.3 \mu A \cdot \left( \frac{C_R}{\mu F} \cdot \frac{V_R}{V} \right)^{0.7} + 4 \mu A$	
Dissipation factor	$\tan \delta$	15%	
Useful life	> 50000 discharges at:		Requirements: $\Delta C/C \leq \pm 20\%$ of initial value ESR $\leq 3$ times initial specified limit $I_{leak} \leq$ initial specified limit
	Case temperature	$\leq 60$ °C	
	Discharge repetition rate	$\geq 2$ s	
	Max. discharges per week	$\leq 5000$	
	Charge resistance	$> 10$ $\Omega$	
	Discharge resistance	$> 0.5$ $\Omega$	
Vibration resistance test	To IEC 60068-2-6, test Fc: Displacement amplitude 0.35 mm, frequency range 10 Hz ... 55 Hz, acceleration max. 5 g, duration $3 \times 2$ h. Capacitor mounted by its body which is rigidly clamped to the work surface. If terminals are used for mechanical fixation of the capacitor, the vibration resistance can be reduced depending on capacitor size.		
IEC climatic category	$V_R \leq 400$ V DC: 40/060/56 (-40 °C/+60 °C/56 days damp heat test) $V_R > 400$ V DC: 25/060/56 (-25 °C/+60 °C/56 days damp heat test)		

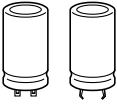

**B43415**

**Compact – up to 60°C**

**Dimensional drawing**

**B43415, solder lug terminals**

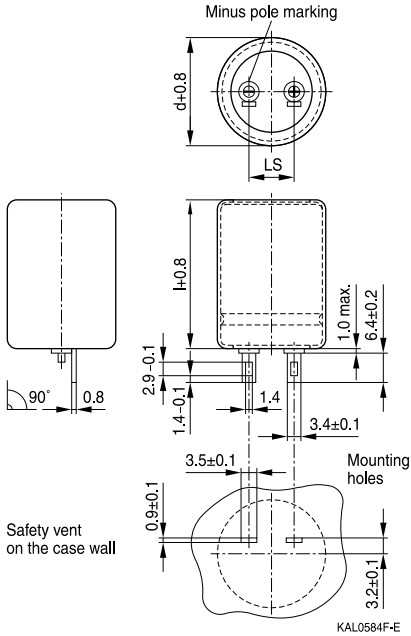

**Dimensions, weights and packing units**

d × l	Lead spacing (LS)	Approx. weight	Packing units
mm	mm	g	pcs.
35 × 55	10.0	75	59
35 × 65	10.0	88	59
40 × 65	10.0	115	42
40 × 70	10.0	130	42
40 × 80	10.0	150	42
40 × 90	10.0	160	42
40 × 105	10.0	180	42
40 × 110	10.0	190	42
50 × 80	20.0	230	28
50 × 100	20.0	270	28

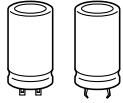
**Technical data and ordering codes – B43415**

$C_R$ 100 Hz 20 °C $\mu\text{F}$	Case dimensions $d \times l$ mm	$I_{\text{leak,max}}$ 5 min. 20 °C mA	Ordering code
<b><math>V_R = 300 \text{ V DC}</math></b>			
2100	35 × 65	3.4	B43415C3218A000
3000	40 × 70	4.4	B43415C3308A000
4700	40 × 105	6.0	B43415C3478A000
6600	50 × 100	7.7	B43415C3668A000
<b><math>V_R = 330 \text{ V DC}</math></b>			
2100	40 × 65	3.7	B43415C8218A000
3000	40 × 80	4.7	B43415C8308A000
3800	40 × 105	5.6	B43415C8388A000
5600	50 × 100	7.3	B43415C8568A000
<b><math>V_R = 360 \text{ V DC}</math></b>			
2100	40 × 65	3.9	B43415C9218A000
3000	40 × 90	5.0	B43415C9308A000
3800	40 × 110	5.9	B43415C9388A000
4900	50 × 100	7.6	B43415C9498A000
<b><math>V_R = 400 \text{ V DC}</math></b>			
1000	35 × 55	2.5	B43415C9108A000
2100	40 × 80	4.2	B43415D9218A000
3000	40 × 110	5.4	B43415D9308A000
3800	50 × 100	6.4	B43415D9388A000
<b><math>V_R = 500 \text{ V DC}</math></b>			
1000	40 × 65	2.9	B43415C6108A000
2100	50 × 80	4.9	B43415C6218A000
2500	50 × 100	5.8	B43415C6258A000

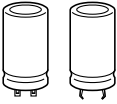

**B43416**

**Compact – up to 60°C**

**Dimensional drawing**

**B43416, snap-in terminals**

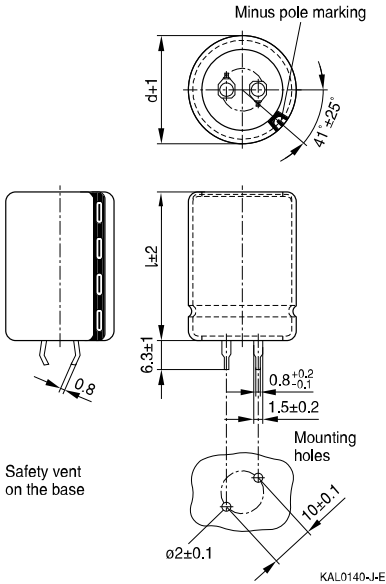

**Dimensions, weights and packing units**

$d \times l$	Approx. weight	Packing units
mm	g	pcs.
25 × 45	25	130
30 × 40	36	80
30 × 50	46	80
35 × 45	56	60
35 × 50	70	60
35 × 55	81	60

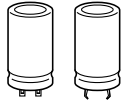

**Technical data and ordering codes – B43416**

$C_R$ 100 Hz 20 °C $\mu\text{F}$	Case dimensions $d \times l$ mm	$I_{\text{leak,max}}$ 5 min. 20 °C mA	Ordering code
<b><math>V_R = 300 \text{ V DC}</math></b>			
1000	30 × 50	2.0	B43416C3108A000
1500	35 × 50	2.7	B43416C3158A000
<b><math>V_R = 330 \text{ V DC}</math></b>			
1000	35 × 45	2.2	B43416C8108A000
1200	35 × 50	2.5	B43416C8128A000
<b><math>V_R = 360 \text{ V DC}</math></b>			
560	30 × 40	1.5	B43416C9567A000
1100	35 × 50	2.6	B43416C9118A000
1200	35 × 55	2.8	B43416C9128A000
<b><math>V_R = 400 \text{ V DC}</math></b>			
330	25 × 45	1.2	B43416C9337A000
700	35 × 45	2.0	B43416C9707A000
900	35 × 55	2.6	B43416C9907A000
<b><math>V_R = 500 \text{ V DC}</math></b>			
200	25 × 45	0.9	B43416C6207A000
560	35 × 50	2.0	B43416C6567A000
600	35 × 55	2.1	B43416C6607A000

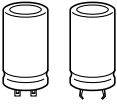

B43415, B43416

Compact – up to 60 °C

### Packing of snap-in capacitors



### Packing of solder lug capacitors



For ecological reasons the packing is pure cardboard.



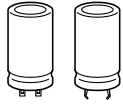

**AC capacitance versus temperature**

$V_R = 350$  V DC  
Typical behaviour

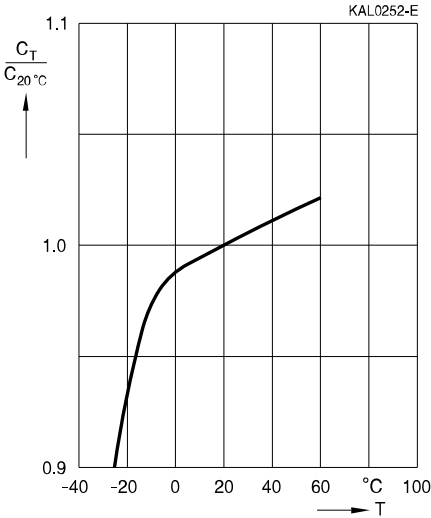

**Dissipation factor  $\tan \delta$  versus temperature**

$V_R = 350$  V DC, measuring frequency = 120 Hz  
Typical behaviour

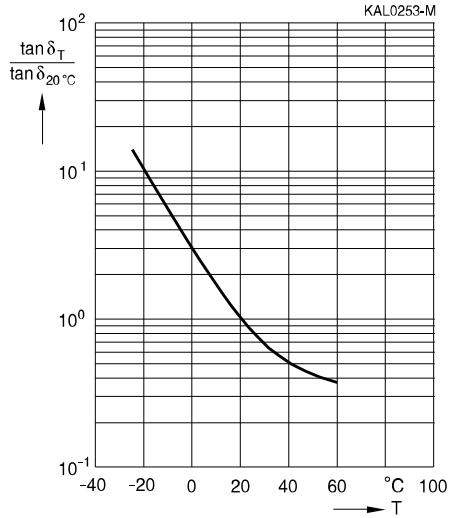

**Leakage current  $I_{leak}$  versus temperature**

Measurement duration = 5 minutes  
Typical behaviour

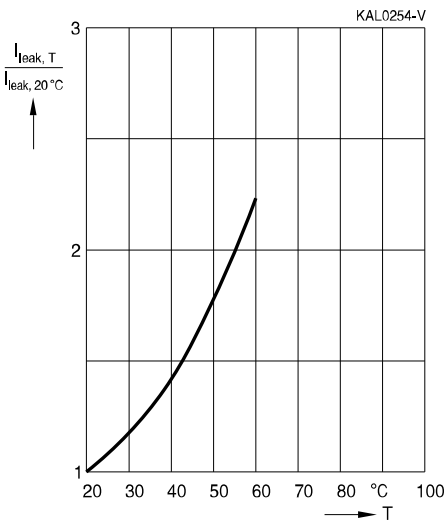



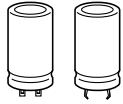

## Cautions and warnings

### Personal safety

The electrolytes used by EPCOS have not only been optimized with a view to the intended application, but also with regard to health and environmental compatibility. They do not contain any solvents that are detrimental to health, e.g. dimethyl formamide (DMF) or dimethyl acetamide (DMAC).

Furthermore, part of the high-voltage electrolytes used by EPCOS are self-extinguishing. They contain flame-retarding substances which will quickly extinguish any flame that may have been ignited.

As far as possible, EPCOS does not use any dangerous chemicals or compounds to produce operating electrolytes. However, in exceptional cases, such materials must be used in order to achieve specific physical and electrical properties because no safe substitute materials are currently known. However, the amount of dangerous materials used in our products has been limited to an absolute minimum. Nevertheless, the following rules should be observed when handling Al electrolytic capacitors:

- Any escaping electrolyte should not come into contact with eyes or skin.
- If electrolyte does come into contact with the skin, wash the affected parts immediately with running water. If the eyes are affected, rinse them for 10 minutes with plenty of water. If symptoms persist, seek medical treatment.
- Avoid breathing in electrolyte vapor or mists. Workplaces and other affected areas should be well ventilated. Clothing that has been contaminated by electrolyte must be changed and rinsed in water.

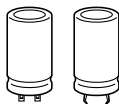
**B43415, B43416**
**Compact – up to 60 °C**

### Product safety

The table below summarize the safety instructions that must be observed without fail. A detailed description can be found in the relevant sections of chapter "General technical information".

Topic	Safety information	Reference Chapter "General technical information"
Polarity	Make sure that polar capacitors are connected with the right polarity.	1 "Basic construction of aluminum electrolytic capacitors"
Reverse voltage	Voltages polarity classes should be prevented by connecting a diode.	3.1.6 "Reverse voltage"
Upper category temperature	Do not exceed the upper category temperatur.	7.2 "Maximum permissible operating temperature"
Maintenance	Make periodic inspections of the capacitors. Before the inspection, make sure that the power supply is turned off and carefully discharge the electricity of the capacitors. Do not apply any mechanical stress to the capacitor terminals.	10 "Maintenance"
Mounting position of screw terminal capacitors	Do not mount the capacitor with the terminals (safety vent) upside down.	11.1 "Mounting positions of capacitors with screw terminals"
Mounting of single-ended capacitors	The internal structure of single-ended capacitors might be damaged if excessive force is applied to the lead wires. Avoid any compressive, tensile or flexural stress. Do not move the capacitor after soldering to PC board. Do not pick up the PC board by the soldered capacitor. Do not insert the capacitor on the PC board with a hole space different to the lead space specified.	11.4 "Mounting considerations for single-ended capacitors"
Robustness of terminals	The following maximum tightening torques must not be exceeded when connecting screw terminals: M5: 2 Nm M6: 2.5 Nm	11.3 "Mounting torques"
Soldering	Do not exceed the specified time or temperature limits during soldering.	11.5 "Soldering"

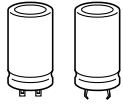

Topic	Safety information	Reference Chapter "General technical information"
Soldering, cleaning agents	Do not allow halogenated hydrocarbons to come into contact with aluminum electrolytic capacitors.	11.6 "Cleaning agents"
Passive flammability	Avoid external energy, such as fire or electricity.	8.1 "Passive flammability"
Active flammability	Avoid overload of the capacitors.	8.2 "Active flammability"
		Reference Chapter "Capacitors with screw terminals"
Breakdown strength of insulating sleeves	Do not damage the insulating sleeve, especially when ring clips are used for mounting.	"Screw terminals - accessories"

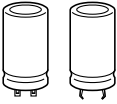
**B43415, B43416**
**Compact – up to 60 °C**
**Symbols and terms**

Symbol	English	German
C	Capacitance	Kapazität
$C_R$	Rated capacitance	Nennkapazität
$C_S$	Series capacitance	Serienkapazität
$C_{S,T}$	Series capacitance at temperature T	Serienkapazität bei Temperatur T
$C_f$	Capacitance at frequency f	Kapazität bei Frequenz f
d	Case diameter, nominal dimension	Gehäusedurchmesser, Nennmaß
$d_{max}$	Maximum case diameter	Maximaler Gehäusedurchmesser
ESL	Self-inductance	Eigeninduktivität
ESR	Equivalent series resistance	Ersatzserienwiderstand
$ESR_f$	Equivalent series resistance at frequency f	Ersatzserienwiderstand bei Frequenz f
$ESR_T$	Equivalent series resistance at temperature T	Ersatzserienwiderstand bei Temperatur T
f	Frequency	Frequenz
I	Current	Strom
$I_{AC}$	Alternating current (ripple current)	Wechselstrom
$I_{AC,rms}$	Root-mean-square value of alternating current	Wechselstrom, Effektivwert
$I_{AC,f}$	Ripple current at frequency f	Wechselstrom bei Frequenz f
$I_{AC,max}$	Maximum permissible ripple current	Maximal zulässiger Wechselstrom
$I_{AC,R}$	Rated ripple current	Nennwechselstrom
$I_{AC,R} (B)$	Rated ripple current for base cooling	Nennwechselstromstrom für Bodenkühlung
$I_{leak}$	Leakage current	Ableitstrom
$I_{leak,op}$	Operating leakage current	Ableitstrom bei Betrieb
l	Case length, nominal dimension	Gehäuselänge, Nennmaß
$l_{max}$	Maximum case length (without terminals and mounting stud)	Maximale Gehäuselänge (ohne Anschlüsse und Gewindebolzen)
R	Resistance	Widerstand
$R_{ins}$	Insulation resistance	Isolationswiderstand
$R_{symm}$	Balancing resistance	Symmetrierwiderstand
T	Temperature	Temperatur
$\Delta T$	Temperature difference	Temperaturdifferenz
$T_A$	Ambient temperature	Umgebungstemperatur
$T_C$	Case temperature	Gehäusetemperatur
$T_B$	Capacitor base temperature	Temperatur des Becherbodens
t	Time	Zeit
$\Delta t$	Period	Zeitraum
$t_b$	Service life (operating hours)	Brauchbarkeitsdauer (Betriebszeit)

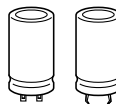

Symbol	English	German
V	Voltage	Spannung
V <sub>F</sub>	Forming voltage	Formierspannung
V <sub>op</sub>	Operating voltage	Betriebsspannung
V <sub>R</sub>	Rated voltage, DC voltage	Nennspannung, Gleichspannung
V <sub>S</sub>	Surge voltage	Spitzenspannung
X <sub>C</sub>	Capacitive reactance	Kapazitiver Blindwiderstand
X <sub>L</sub>	Inductive reactance	Induktiver Blindwiderstand
Z	Impedance	Scheinwiderstand
Z <sub>T</sub>	Impedance at temperature T	Scheinwiderstand bei Temperatur T
tan δ	Dissipation factor	Verlustfaktor
λ	Failure rate	Ausfallrate
ε <sub>0</sub>	Absolute permittivity	Elektrische Feldkonstante
ε <sub>r</sub>	Relative permittivity	Dielektrizitätszahl
ω	Angular velocity; 2 · π · f	Kreisfrequenz; 2 · π · f

### Notes

All dimensions are given in mm.

## Important notes

The following applies to all products named in this publication:

1. Some parts of this publication contain **statements about the suitability of our products for certain areas of application**. These statements are based on our knowledge of typical requirements that are often placed on our products in the areas of application concerned. We nevertheless expressly point out **that such statements cannot be regarded as binding statements about the suitability of our products for a particular customer application**. As a rule, EPCOS is either unfamiliar with individual customer applications or less familiar with them than the customers themselves. For these reasons, it is always ultimately incumbent on the customer to check and decide whether an EPCOS product with the properties described in the product specification is suitable for use in a particular customer application.
2. We also point out that **in individual cases, a malfunction of electronic components or failure before the end of their usual service life cannot be completely ruled out in the current state of the art, even if they are operated as specified**. In customer applications requiring a very high level of operational safety and especially in customer applications in which the malfunction or failure of an electronic component could endanger human life or health (e.g. in accident prevention or lifesaving systems), it must therefore be ensured by means of suitable design of the customer application or other action taken by the customer (e.g. installation of protective circuitry or redundancy) that no injury or damage is sustained by third parties in the event of malfunction or failure of an electronic component.
3. **The warnings, cautions and product-specific notes must be observed.**
4. In order to satisfy certain technical requirements, **some of the products described in this publication may contain substances subject to restrictions in certain jurisdictions (e.g. because they are classed as hazardous)**. Useful information on this will be found in our Material Data Sheets on the Internet ([www.epcos.com/material](http://www.epcos.com/material)). Should you have any more detailed questions, please contact our sales offices.
5. We constantly strive to improve our products. Consequently, **the products described in this publication may change from time to time**. The same is true of the corresponding product specifications. Please check therefore to what extent product descriptions and specifications contained in this publication are still applicable before or when you place an order. We also **reserve the right to discontinue production and delivery of products**. Consequently, we cannot guarantee that all products named in this publication will always be available. The aforementioned does not apply in the case of individual agreements deviating from the foregoing for customer-specific products.
6. Unless otherwise agreed in individual contracts, **all orders are subject to the current version of the "General Terms of Delivery for Products and Services in the Electrical Industry" published by the German Electrical and Electronics Industry Association (ZVEI)**.
7. The trade names EPCOS, BAOKE, Alu-X, CeraDiode, CSSP, CTVS, DSSP, MiniBlue, MKK, MLSC, MotorCap, PCC, PhaseCap, PhaseMod, SIFERRIT, SIFI, SIKOREL, SilverCap, SIMDAD, SIMID, SineFormer, SIOV, SIP5D, SIP5K, ThermoFuse, WindCap are **trademarks registered or pending** in Europe and in other countries. Further information will be found on the Internet at [www.epcos.com/trademarks](http://www.epcos.com/trademarks).