

High Frequency Relay G6Y

Economical HF Relay Design Based on Micro Strip Line Technology

- Isolation characteristics of 65 dB or better at 900 MHz.
- Effective insertion loss of 0.2 dB (typical) at 900 MHz.
- Fully sealed construction.
- Improved shock-resistance.
- Form, fit and function replacement to G5Y relay with improved characteristics
- RoHS Compliant

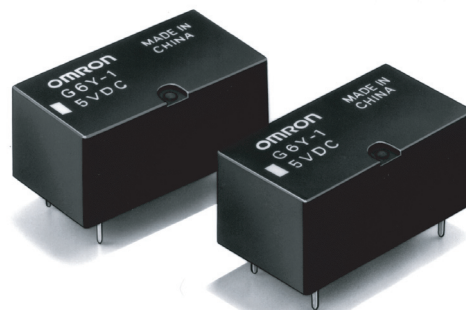

Ordering Information

To order: Select the part number and add the desired coil voltage rating (e.g. G6Y-1-DC12).

Type	Contact Form	Construction	Part Number
Standard	SPDT	Fully-sealed	G6Y-1

Model Number Legend

G6Y - - DC

1 2

1. Contact Form
1: SPDT

2. Rated Coil Voltage
4.5, 5, 9, 12, 24

Application Examples

- **Wired Communications:** Cable TV, captain systems, and video response systems
- **Wireless Communications:** Transceivers, ham radio, fax machines, satellite broadcasting, text multiplex broadcasting
- **Entertainment Equipment:** TVs, DVD players, and video games
- **Industrial Equipment:** Measuring equipment, test equipment, and multiplex transmission devices

Specifications

■ Contact Ratings

Load type	Resistive load
Contact Material	Au clad Cu alloy
Rated load	0.01 A at 30 VAC 0.01 A at 30 VDC 900 MHz, 1 W (See note.)
Rated carry current	0.5 A
Max. switching voltage	30 VAC 30 VDC
Max. switching current	0.5 A
Max. switching capacity (reference value)	AC10VA DC10W

Note: This value is for a load with V.S.W.R. of 1.2 max.

■ High-frequency Characteristics

Item	250 MHz	900 MHz	2.5 GHz
Isolation	80 db min.	65 dB min.	30 dB min.
Insertion loss	0.5 dB max.	0.5 dB max.	---
V.S.W.R.	1.5 max.	1.5 max.	---
Max. carry power	10 W		---
Max. switching power	10 W (See note 3.)		---

- Note:**
1. The impedance of the measuring system is 50 Ω.
 2. The table above shows preliminary values.
 3. This value is for a load with V.S.W.R. of 1.2 max.

Coil Ratings

Rated voltage (VDC)	Rated current (mA)	Coil resistance (Ω)	Operating voltage (V)	Release voltage (V)	Maximum voltage (V)	Power consumption (mW)
4.5	44.4	101	75% max. of rated voltage	10% min. of rated voltage	150% of rated voltage at 23°C	Approx. 200
5	40.0	125				
9	22.2	405				
12	16.7	720				
24	8.3	2,880				

- Note:**
- The rated current and coil resistance are measured at a coil temperature of 23°C with a tolerance of $\pm 10\%$.
 - The operating characteristics are measured at a coil temperature of 23°C.
 - The maximum voltage is the highest voltage that can be imposed on the relay coil instantaneously. It is not the maximum voltage that can be applied continuously.

Characteristics

Contact resistance (See note 2.)	100 m Ω max.
Operating time	10 ms max. (approx. 5 ms, typ.)
Release time	5 ms max. (approx. 1 ms, typ.)
Insulation resistance (See note 3.)	100 M Ω min.
Dielectric strength	1,000 VAC, 50/60 Hz for 1 min between coil and contacts
	500 VAC, 50/60 Hz for 1 min between contacts of same polarity
	500 VAC, 50/60 Hz for 1 min between coil and ground and between contacts and ground
Vibration resistance	Destruction: 10 to 55 Hz, 1.5 mm double amplitude
	Malfunction: 10 to 55 Hz, 1.5 mm double amplitude
Shock resistance	Destruction: 1,000 m/s ² (approx. 100G)
	Malfunction: 500 m/s ² (approx. 50G)
Life expectancy	Mechanical: 1,000,000 operations min. (at 1,800 operations/hr)
	Electrical: 300,000 operations min. (under rated load at 1,800 operations/hr)
Ambient temperature	Operating: -40°C to 70°C (with no icing)
Ambient humidity	Operating: 5 to 85%
Weight	Approx. 5 g

- Note:**
- The table above shows preliminary values.
 - The contact resistance was measured with 100mA at 5VDC with a voltage drop method.
 - The insulation resistance was measured with a 500-VDC megohmmeter applied to the same points as those used for checking the dielectric strength.

Engineering Data

Ambient Temperature vs. Maximum Coil Voltage

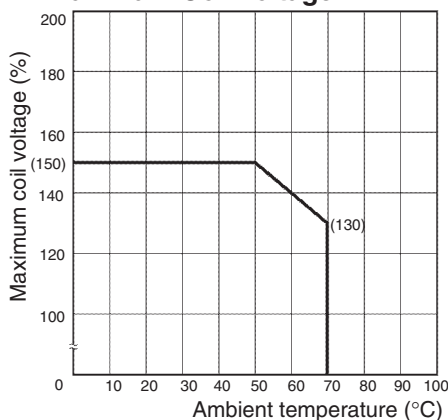

Note: The maximum coil voltage refers to the maximum value in a varying range of operating power voltage, not a continuous voltage.

Resistance to Shock

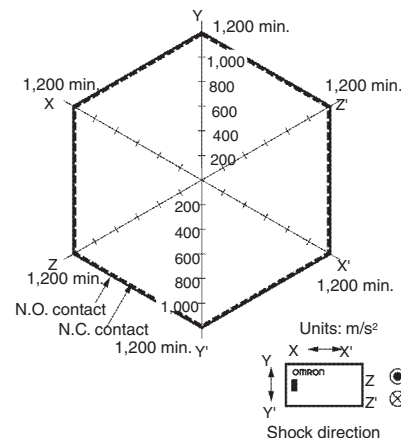

Quantity Tested: 10 Units Rating: 500 m/s²

Test Method: Shock was applied 3 times in each direction with and without excitation and the level at which the shock caused malfunction was measured.

High-frequency Characteristics Measurement Conditions

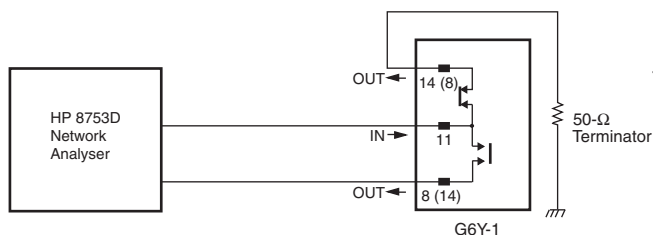

Terminals which were not being measured were terminated with 50 Ω.

Note: The high-frequency characteristics data were measured using a dedicated circuit board and actual values will vary depending on the usage conditions. Check the characteristics of the actual equipment being used.

Isolation, Average Values (See notes 1 and 2.)

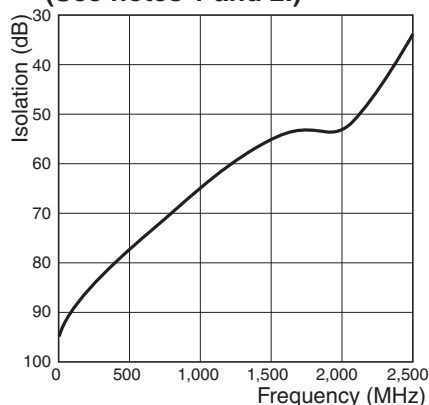

Insertion Loss, Average Values (See notes 1 and 2.)

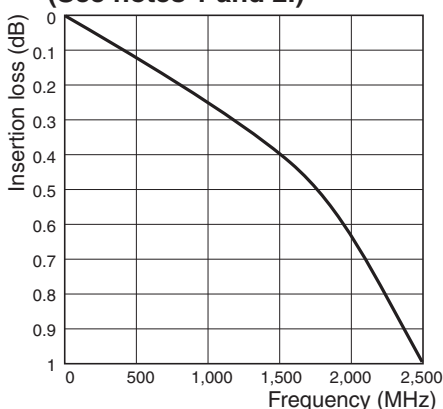

V.S.W.R. / Return Loss, Average Values (See notes 1 and 2.)

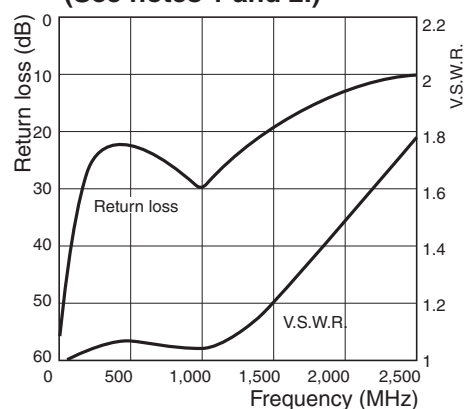

Operating/Release Time Distribution (See note 1.)

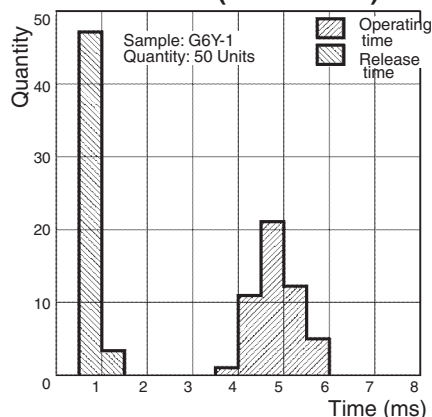

Bounce Time Distribution (See note 1.)

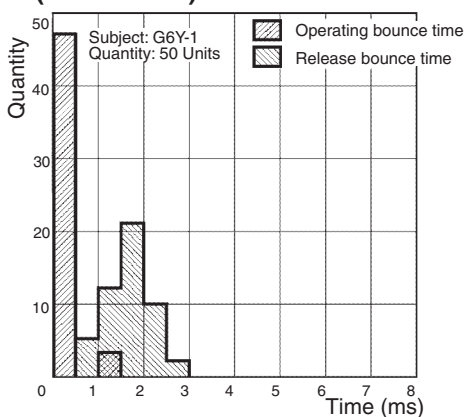

Note: 1. The tests were conducted at an ambient temperature of 23°C.

2. High-frequency characteristics depend on the PCB to which the Relay is mounted. Always check these characteristics, including endurance (life expectancy), in the actual machine before use.

Dimensions

Note: All units are in millimeters unless otherwise indicated.

G6Y-1

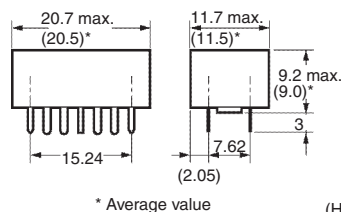
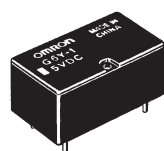

* Average value

PCB Dimensions (Bottom View)

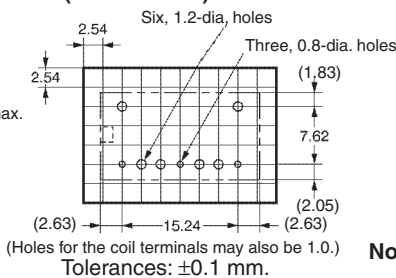

Terminal Arrangement/ Internal Connections (Bottom View)

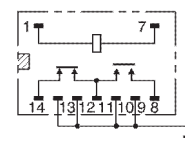

(There is no polarity to the coil.)

Note: The shaded and unshaded parts indicate the product's directional marks.

Precautions

■ Correct Use

Long-term Continuously ON Contacts

Using the Relay in a circuit where the Relay will be ON continuously for long periods (without switching) can lead to unstable contacts because the heat generated by the coil itself will affect the insulation, causing a film to develop on the contact surfaces. Be sure to use a fail-safe circuit design that provides protection against contact failure or coil burnout.

Seal integrity during cleaning will last 1 minute at 70°C. Complete cleaning within these conditions.

Micro Strip Line Design

It is advantageous to use the Micro Strip Line in high-frequency transmission circuits because a low-loss transmission can be constructed with this method. By etching the dielectric base which has copper foil attached to both sides, the Micro Strip Line will have a concentrated electric field between the lines and ground as shown in the following diagram.

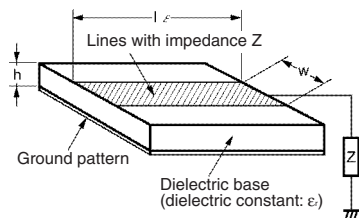

The characteristic impedance of the lines Z_0 is determined by the kind of base (dielectric constant), the base's thickness, and the width of the lines, as expressed in the following equation.

$$Z_0 = \frac{377}{\sqrt{\epsilon_r} \frac{W}{H} \left\{ 1 + \frac{2H}{\pi W} \left[1 + \ln \frac{\pi W}{H} \right] \right\}}$$

W: Line width

ϵ_r : Effective dielectric constant

H: Dielectric base thickness

The copper foil thickness must be less than H.

The following graph shows this relationship.

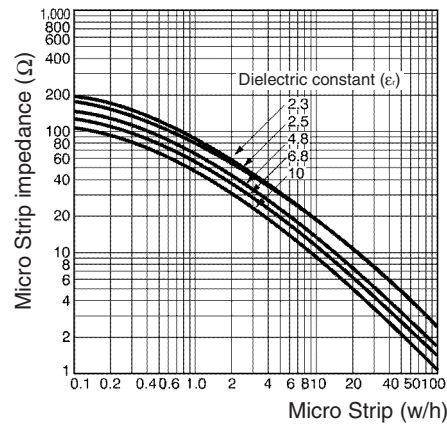

- For example, when creating 50-Ω lines using a glass epoxy base with a thickness of 1.6 mm, the above graph will yield a w/h ratio of 1.7 for a dielectric constant of 4.8. Since the base thickness is 1.6 mm, the width will be $h \times 1.7 \approx 2.7$ mm. The thickness of the copper foil "t" is ignored in this design method, but it must be considered because large errors will occur in extreme cases such as a foil thickness of $t \approx w$. Furthermore, with the Micro Strip Line design, the lines are too short for the G6Y's intended frequency bandwidths, so we can ignore conductive losses and the line's attenuation constant.
- The spacing of the Strip Lines and ground pattern should be comparable to the width of the Strip Lines.
- Design the pattern with the shortest possible distances. Excessive distances will adversely effect the high-frequency characteristics.
- Spread the ground patterns as widely as possible so that potential differences are unlikely to develop between the ground patterns.
- To avoid potential short-circuits, do not place the pattern's leads near the point where the bottom of the Relay attaches to the board.

Bending the Micro Strip Line

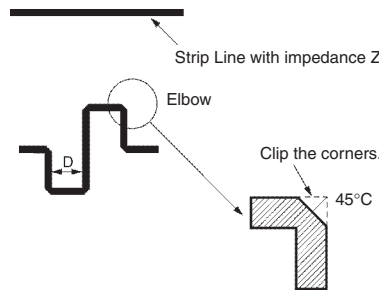

When the lines must curve, an elbow can be used as shown in the diagram. A distance (D) between the lines of approximately twice the line width is sufficient.

Relay Handling

When washing the product after soldering the Relay to a PCB, use a water-based solvent or alcohol-based solvent, and keep the solvent temperature to less than 40°C. Do not put the Relay in a cold cleaning bath immediately after soldering.

Examples of Mounting Designs

Since this example emphasizes reducing mounting costs, expensive mounting methods such as through-hole boards are not shown. If such methods are to be used, the characteristics must be studied carefully using the actual board configuration.

Using a Double-sided Paper Epoxy Board

When double-sided paper epoxy boards are used, the dielectric constant will be approximately the same as that of glass epoxy boards ($\epsilon_r=4.8$).

The width of the Strip Lines for a board with $t=1.6$ mm is 2.7 mm for 50 Ω and 1.3 mm for 75 Ω . For a board with $t=1.0$ mm the width is 1.7 mm for 50 Ω and 0.8 mm for 75 Ω .

The following diagram shows an example pattern and the Micro Strip Lines connected to the contact terminals are formed with pattern widths derived from the description above. The width between the Micro Strip Lines and ground patterns are comparable to the Micro Strip Line width.

There are jumpers between the upper and lower patterns at the points marked with Xs in the diagram. Improved characteristics can be obtained with more jumper locations. This method yields isolation characteristics of 65 dB to 75 dB at 500 MHz and 50 dB at 900 MHz.

At this point in the diagram the component side is the entire ground pattern side, but set aside approximately 2.0 mm \times 2.0 mm of the pattern for the contact terminals and coil terminals.

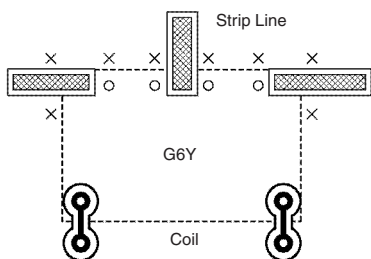

Using a Single-sided Board

When a single-sided board is used, isolation characteristics of only 60 dB to 70 dB at 200 MHz can be obtained. When high frequency bands are to be used with a single-sided board, a metal plate can be placed between the base and Relay and connected to the ground pattern.

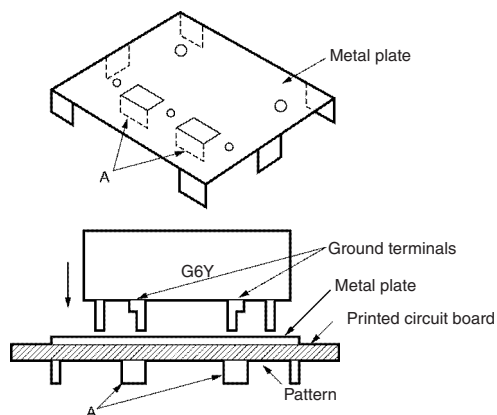

With this method a metal plate is placed between the Relay and base and connected to the pattern, as shown in the above diagram. The important point here is that 3 locations (the G6Y's ground terminal, the metal plate's bent tabs (A), and the ground pattern) are soldered together at the same time. This method combines an inexpensive single-sided board and inexpensive metal plate to yield the same characteristics as a double-sided board. Good characteristics are obtained by grounding the G6Y's ground terminal and metal plate in the same place.

The metal plate must be attached to the base as described here. From this point, the methods used for Strip Line design are the same as for the double-sided board.

Mounting Precautions

Be sure to securely attach the Relay's base surface to the board during installation. The isolation characteristics will be affected if the Relay lifts off the board.

As shown in the enlarged illustration of the cross-section of part A, the G6Y is designed to ensure better high-frequency characteristics if the stand-off part of the G6Y is in contact with the ground pattern of the PCB. Therefore, the ground terminal and stand-off part are electrically connected internally.

Should the through hole electrically connected to the contact terminal come in contact with the stand-off part, the contact will be short-circuited with the ground, which may cause an accident.

As a preventive measure, keep at least a distance of 0.3 mm between the stand-off part and the through hole or land.

For example, if the terminal hole on the PCB is 1 mm in diameter and the length B shown in the illustration is 1.4 mm, a distance of 0.3 mm or more will be provided between the through hole and stand-off part.

PCB Mounting

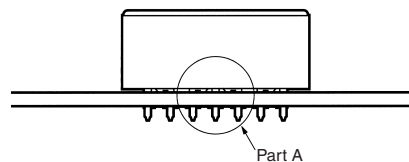

Cross-section of Part A

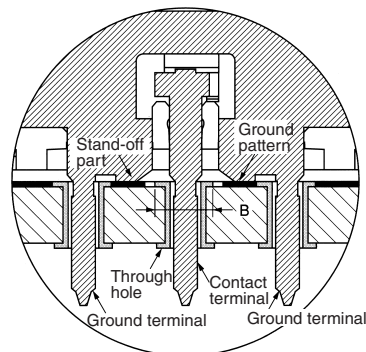

MEMO

A large grid of dashed lines for taking notes, consisting of 20 columns and 30 rows of small squares.

Omron Electronic Components, LLC

Terms and Conditions of Sales

I. GENERAL

- Definitions:** The words used herein are defined as follows.
 - Terms:** These terms and conditions
 - Seller:** Omron Electronic Components LLC and its subsidiaries
 - Buyer:** The buyer of Products, including any end user in section III through VI
 - Products:** Products and/or services of Seller
 - Including:** Including without limitation
- Offer; Acceptance:** These Terms are deemed part of all quotations, acknowledgments, invoices, purchase orders and other documents, whether electronic or in writing, relating to the sale of Products by Seller. Seller hereby objects to any Terms proposed in Buyer's purchase order or other documents which are inconsistent with, or in addition to, these Terms.
- Distributor:** Any distributor shall inform its customer of the contents after and including section III of these Terms.

II. SALES

- Prices; Payment:** All prices stated are current, subject to change without notice by Seller. Buyer agrees to pay the price in effect at the time the purchase order is accepted by Seller. Payments for Products received are due net 30 days unless otherwise stated in the invoice. Buyer shall have no right to set off any amounts against the amount owing in respect of this invoice.
- Discounts:** Cash discounts, if any, will apply only on the net amount of invoices sent to Buyer after deducting transportation charges, taxes and duties, and will be allowed only if (a) the invoice is paid according to Seller's payment terms and (b) Buyer has no past due amounts owing to Seller.
- Interest:** Seller, at its option, may charge Buyer 1.5% interest per month or the maximum legal rate, whichever is less, on any balance not paid within the stated terms.
- Orders:** Seller will accept no order less than 200 U.S. dollars net billing.
- Currencies:** If the prices quoted herein are in a currency other than U.S. dollars, Buyer shall make remittance to Seller at the then current exchange rate most favorable to Seller; provided that if remittance is not made when due, Buyer will convert the amount to U.S. dollars at the then current exchange rate most favorable to Seller available during the period between the due date and the date remittance is actually made.
- Governmental Approvals:** Buyer shall be responsible for all costs involved in obtaining any government approvals regarding the importation or sale of the Products.
- Taxes:** All taxes, duties and other governmental charges (other than general real property and income taxes), including any interest or penalties thereon, imposed directly or indirectly on Seller or required to be collected directly or indirectly by Seller for the manufacture, production, sale, delivery, importation, consumption or use of the Products sold hereunder (including customs duties and sales, excise, use, turnover and license taxes) shall be charged to and remitted by Buyer to Seller.
- Financial:** If the financial position of Buyer at any time becomes unsatisfactory to Seller, Seller reserves the right to stop shipments or require satisfactory security or payment in advance. If Buyer fails to make payment or otherwise comply with these Terms or any related agreement, Seller may (without liability and in addition to other remedies) cancel any unshipped portion of Products sold hereunder and stop any Products in transit until Buyer pays all amounts, including amounts payable hereunder, whether or not then due, which are owing to it by Buyer. Buyer shall in any event remain liable for all unpaid accounts.
- Cancellation; Etc:** Orders are not subject to rescheduling or cancellation unless Buyer indemnifies Seller fully against all costs or expenses arising in connection therewith.
- Force Majeure:** Seller shall not be liable for any delay or failure in delivery resulting from causes beyond its control, including earthquakes, fires, floods, strikes or other labor disputes, shortage of labor or materials, accidents to machinery, acts of sabotage, riots, delay in or lack of transportation or the requirements of any government authority.
- Shipping; Delivery:** Unless otherwise expressly agreed in writing by Seller:
 - All sales and shipments of Products shall be FOB shipping point (unless otherwise stated in writing by Seller), at which point title to and all risk of loss of the Products shall pass from Seller to Buyer, provided that Seller shall retain a security interest in the Products until the full purchase price is paid by Buyer;
 - Delivery and shipping dates are estimates only; and
 - Seller will package Products as it deems proper for protection against normal handling and extra charges apply to special conditions.
- Claims:** Any claim by Buyer against Seller for shortage or damage to the Products occurring before delivery to the carrier or any claim related to pricing or other charges must be presented in detail in writing to Seller within 30 days of receipt of shipment.

III. PRECAUTIONS

- Suitability:** IT IS THE BUYER'S SOLE RESPONSIBILITY TO ENSURE THAT ANY OMRON PRODUCT IS FIT AND SUFFICIENT FOR USE IN A MOTORIZED VEHICLE APPLICATION. BUYER SHALL BE SOLELY RESPONSIBLE FOR DETERMINING APPROPRIATENESS OF THE PARTICULAR PRODUCT WITH RESPECT TO THE BUYER'S APPLICATION INCLUDING (A) ELECTRICAL OR ELECTRONIC COMPONENTS, (B) CIRCUITS, (C) SYSTEM ASSEMBLIES, (D) END PRODUCT, (E) SYSTEM, (F) MATERIALS OR SUBSTANCES OR (G) OPERATING ENVIRONMENT. Buyer acknowledges that it alone has determined that the Products will meet their requirements of the intended use in all cases. Buyer must know and observe all prohibitions of use applicable to the Product/s.
- Use with Attention:** The followings are some examples of applications for which particular attention must be given. This is not intended to be an exhaustive list of all possible use of any Product, nor to imply that any use listed may be suitable for any Product:
 - Outdoor use, use involving potential chemical contamination or electrical interference.

- Use in consumer Products or any use in significant quantities.
 - Energy control systems, combustion systems, railroad systems, aviation systems, medical equipment, amusement machines, vehicles, safety equipment, and installations subject to separate industry or government regulations.
 - Systems, machines, and equipment that could present a risk to life or property.
- Prohibited Use:** NEVER USE THE PRODUCT FOR AN APPLICATION INVOLVING SERIOUS RISK TO LIFE OR PROPERTY WITHOUT ENSURING THAT THE SYSTEM AS A WHOLE HAS BEEN DESIGNED TO ADDRESS THE RISKS, AND THAT THE PRODUCT IS PROPERLY RATED AND INSTALLED FOR THE INTENDED USE WITHIN THE OVERALL EQUIPMENT OR SYSTEM.
 - Motorized Vehicle Application:** USE OF ANY PRODUCT/S FOR A MOTORIZED VEHICLE APPLICATION MUST BE EXPRESSLY STATED IN THE SPECIFICATION BY SELLER.
 - Programmable Products:** Seller shall not be responsible for the Buyer's programming of a programmable Product.

IV. WARRANTY AND LIMITATION

- Warranty:** Seller's exclusive warranty is that the Products will be free from defects in materials and workmanship for a period of twelve months from the date of sale by Seller (or such other period expressed in writing by Seller). SELLER MAKES NO WARRANTY OR REPRESENTATION, EXPRESS OR IMPLIED, ABOUT ALL OTHER WARRANTIES, NON-INFRINGEMENT, MERCHANTABILITY OR FITNESS FOR A PARTICULAR PURPOSE OF THE PRODUCTS.
- Buyer Remedy:** Seller's sole obligation hereunder shall be to replace (in the form originally shipped with Buyer responsible for labor charges for removal or replacement thereof) the non-complying Product or, at Seller's election, to repay or credit Buyer an amount equal to the purchase price of the Product; provided that there shall be no liability for Seller or its affiliates unless Seller's analysis confirms that the Products were correctly handled, stored, installed and maintained and not subject to contamination, abuse, misuse or inappropriate modification. Return of any Products by Buyer must be approved in writing by Seller before shipment.
- Limitation on Liability:** SELLER AND ITS AFFILIATES SHALL NOT BE LIABLE FOR SPECIAL, INDIRECT, INCIDENTAL OR CONSEQUENTIAL DAMAGES, LOSS OF PROFITS OR PRODUCTION OR COMMERCIAL LOSS IN ANY WAY CONNECTED WITH THE PRODUCTS, WHETHER SUCH CLAIM IS BASED IN CONTRACT, WARRANTY, NEGLIGENCE OR STRICT LIABILITY. FURTHER, IN NO EVENT SHALL LIABILITY OF SELLER OR ITS AFFILIATES EXCEED THE INDIVIDUAL PRICE OF THE PRODUCT ON WHICH LIABILITY IS ASSERTED.
- Indemnities:** Buyer shall indemnify and hold harmless Seller, its affiliates and its employees from and against all liabilities, losses, claims, costs and expenses (including attorney's fees and expenses) related to any claim, investigation, litigation or proceeding (whether or not Seller is a party) which arises or is alleged to arise from Buyer's acts or omissions under these Terms or in any way with respect to the Products.

V. INFORMATION; ETC.

- Intellectual Property:** The intellectual property embodied in the Products is the exclusive property of Seller and its affiliates and Buyer shall not attempt to duplicate it in any way without the written permission of Seller. Buyer (at its own expense) shall indemnify and hold harmless Seller and defend or settle any action brought against Seller to the extent that it is based on a claim that any Product made to Buyer specifications infringed intellectual property rights of another party.
- Property; Confidentiality:** Notwithstanding any charges to Buyer for engineering or tooling, all engineering and tooling shall remain the exclusive property of Seller. All information and materials supplied by Seller to Buyer relating to the Products are confidential and proprietary, and Buyer shall limit distribution thereof to its trusted employees and strictly prevent disclosure to any third party.
- Performance Data:** Performance data is provided as a guide in determining suitability and does not constitute a warranty. It may represent the result of Seller's test conditions, and the users must correlate it to actual application requirements.
- Change In Specifications:** Product specifications and descriptions may be changed at any time based on improvements or other reasons. It is Seller's practice to change part numbers when published ratings or features are changed, or when significant engineering changes are made. However, some specifications of the Product may be changed without any notice.
- Errors And Omissions:** The information on Seller's website or in other documentation has been carefully checked and is believed to be accurate; however, no responsibility is assumed for clerical, typographical or proofreading errors or omissions.
- Export Controls:** Buyer shall comply with all applicable laws, regulations and licenses regarding (a) export of the Products or information provided by Seller; (b) sale of Products to forbidden or other proscribed persons or organizations; (c) disclosure to non-citizens of regulated technology or information.

VI. MISCELLANEOUS

- Waiver:** No failure or delay by Seller in exercising any right and no course of dealing between Buyer and Seller shall operate as a waiver of rights by Seller.
- Assignment:** Buyer may not assign its rights hereunder without Seller's written consent.
- Law:** These Terms are governed by Illinois law (without regard to conflict of laws). Federal and state courts in Cook County, Illinois have exclusive jurisdiction for any dispute hereunder.
- Amendment:** These Terms constitute the entire agreement between Buyer and Seller relating to the Products, and no provision may be changed or waived unless in writing signed by the parties.
- Severability:** If any provision hereof is rendered ineffective or invalid, such provision shall not invalidate any other provision.

Certain Precautions on Specifications and Use

1. **Suitability for Use.** Seller shall not be responsible for conformity with any standards, codes or regulations which apply to the combination of the Product in Buyer's application or use of the Product. At Buyer's request, Seller will provide applicable third party certification documents identifying ratings and limitations of use which apply to the Product. This information by itself is not sufficient for a complete determination of the suitability of the Product in combination with the end product, machine, system, or other application or use. Buyer shall be solely responsible for determining appropriateness of the particular Product with respect to Buyer's application, product or system. Buyer shall take application responsibility in all cases but the following is a non-exhaustive list of applications for which particular attention must be given:
 - (i) Outdoor use, uses involving potential chemical contamination or electrical interference, or conditions or uses not described in this document.
 - (ii) Energy control systems, combustion systems, railroad systems, aviation systems, medical equipment, amusement machines, vehicles, safety equipment, and installations subject to separate industry or government regulations.
 - (iii) Use in consumer products or any use in significant quantities.
 - (iv) Systems, machines and equipment that could present a risk to life or property. Please know and observe all prohibitions of use applicable to this product.

NEVER USE THE PRODUCT FOR AN APPLICATION INVOLVING SERIOUS RISK TO LIFE OR PROPERTY WITHOUT ENSURING THAT THE SYSTEM AS A WHOLE HAS BEEN DESIGNED TO ADDRESS THE RISKS, AND THAT THE OMRON PRODUCT IS PROPERLY RATED AND INSTALLED FOR THE INTENDED USE WITHIN THE OVERALL EQUIPMENT OR SYSTEM.
2. **Programmable Products.** Seller shall not be responsible for the user's programming of a programmable product, or any consequence thereof.
3. **Performance Data.** Performance data given in this publication is provided as a guide for the user in determining suitability and does not constitute a warranty. It may represent the result of Seller's test conditions, and the users must correlate it to actual application requirements. Actual performance is subject to Seller's Warranty and Limitations of Liability.
4. **Change in Specifications.** Product specifications and accessories may be changed at any time based on improvements and other reasons. It is our practice to change part numbers when published ratings or features are changed, or when significant construction changes are made. However, some specifications of the Product may be changed without any notice. When in doubt, special part numbers may be assigned to fix or establish key specifications for your application. Please consult with your Seller representative at any time to confirm actual specifications of purchased Product.
5. **Errors and Omissions.** The information in this publication has been carefully checked and is believed to be accurate; however, no responsibility is assumed for clerical, typographical or proofreading errors, or omissions.
6. **RoHS Compliance.** Where indicated, our products currently comply, to the best of our knowledge as of the date of this publication, with the requirements of the European Union's Directive on the Restriction of certain Hazardous Substances ("RoHS"), although the requirements of RoHS do not take effect until July 2006. These requirements may be subject to change. Please consult our website for current information.

Complete "Terms and Conditions of Sale" for product purchase and use are on Omron's website at <http://www.components.omron.com> – under the "About Us" tab, in the Legal Matters section.

ALL DIMENSIONS SHOWN ARE IN MILLIMETERS.

To convert millimeters into inches, multiply by 0.03937. To convert grams into ounces, multiply by 0.03527.

OMRON®

**OMRON ELECTRONIC
COMPONENTS LLC**

55 E. Commerce Drive, Suite B
Schaumburg, IL 60173

847-882-2288

OMRON ON-LINE

Global - <http://www.omron.com>

USA - <http://www.components.omron.com>