

35-75 V Input	12 V Outputs	17 A Current	2250 V dc Isolation	Quarter-brick DC-DC Converter
-------------------------	------------------------	------------------------	-------------------------------	---

The PQ60120QEA17 PowerQor® Exa quarter-brick converter is a next-generation, board-mountable, isolated, fixed switching frequency DC/DC converter. The Exa series offers industry leading power density for standard isolated DC/DC converters with both a wide input range and a tightly regulated output. Targeted for use in intermediate bus architectures, this module supplies an isolated step down voltage from 35-75V to 12V. This converter is available in open-frame and base-plated versions. RoHS Compliant (see page 14).

PowerQor®
Exa



PQ60120QEA17
Module

Operational Features

- Ultra-high efficiency, >95% at full rated load current, >96% at half rated load current
- Delivers up to 17 A of output current (200 W) with minimal derating - no heatsink required
- Wide input voltage range: 35V – 75V, with 100V 100ms input voltage transient capability
- Fixed frequency switching provides predictable EMI performance
- No minimum load requirement means no preload resistors required
- Wide output voltage trim range (-50% to +5%), see trim section

Mechanical Features

- Industry standard quarter-brick pin-out configuration
- Industry standard size: 1.45" x 2.3" (36.8x58.4mm)
- Total height less than 0.436" (11.06mm), permits better airflow and smaller card pitch
- Total weight: 1.6 oz. (46 grams)
- Open frame units have flanged pins designed to permit surface mount soldering (avoid wave solder) using FPIP technique

Control Features

- On/Off control referenced to input side (positive and negative logic options are available)

Protection Features

- Input under-voltage lockout disables converter at low input voltage conditions
- Output current limit and short circuit protection protects converter and load from permanent damage and consequent hazardous conditions
- Active back bias limit provides smooth startup with external load induced pre-bias
- Latching output over-voltage protection protects load from damaging voltages
- Thermal shutdown protects converter from abnormal environmental conditions

Safety Features

- 2250 V, 30 MΩ input-to-output isolation
- UL 60950-1:2003 Basic Insulation
- CAN/CSA-C22.2 No. 60950-1:2003
- EN60950-1:2001
- RoHS compliant (see page 14)

Contents

	Page No.
MECHANICAL DIAGRAM (open frame)	2
MECHANICAL DIAGRAM (base-plated)	3
PQ60120QEA17 ELECTRICAL CHARACTERISTICS	4-5
PQ60120QEA17 STANDARDS and QUALIFICATION	6-9
Application Section	10-13
ORDERING INFORMATION	14

Input: 35-75 V
Output: 12 V
Current: 17 A (200W)
Package: Quarter-brick

MECHANICAL DIAGRAM (open frame)

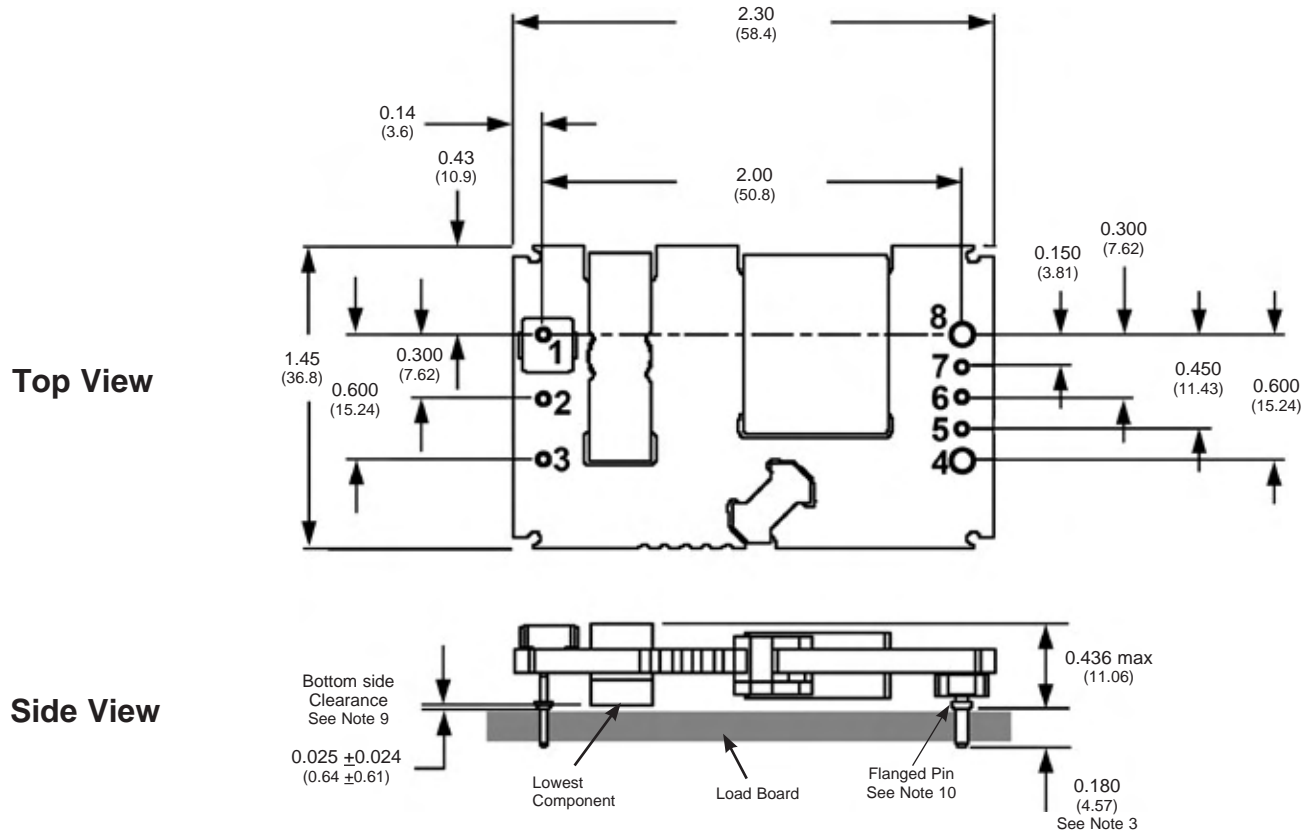

NOTES

- Pins 1-3, 5-7 are 0.040" (1.02mm) diameter with 0.080" (2.03 mm) diameter standoff shoulders.
- Pins 4 and 8 are 0.062" (1.57 mm) diameter with 0.100" (2.54 mm) diameter standoff shoulders.
- Other pin extension lengths available. Recommended pin length is 0.03" (0.76mm) greater than the PCB thickness.
- All Pins: Material - Copper Alloy
 Finish (RoHS 5/6) - Tin/Lead over Nickel plate
 Finish (RoHS 6/6) - Matte Tin over Nickel plate
- Undimensioned components are shown for visual reference only.
- All dimensions in inches (mm)
 Tolerances: x.xx +0.02 in. (x.x +0.5mm)
 x.xxx +0.010 in. (x.xx +0.25mm)
- Weight: 1.5 oz. (42 g) typical
- Workmanship: Meets or exceeds IPC-A-610C Class II
- UL/TUV standards require a clearance greater than 0.04" (1.02mm) between input and output for basic insulation. This issue should be considered if any copper traces are on the top side of the user's board. Note that the ferrite cores are considered part of the input/primary circuit.
- The flanged pins are designed to permit surface mount soldering (allowing to avoid the wave soldering process) through the use of the flanged pin-in-paste technique.

PIN DESIGNATIONS

PIN	NAME	FUNCTION
1	Vin(+)	Positive input voltage
2	ON/OFF	TTL input to turn converter on and off, referenced to Vin(-), with internal pull up.
3	Vin(-)	Negative input voltage
4	Vout(-)	Negative output voltage
5	SENSE(-)	Negative remote sense ¹
6	TRIM	Output voltage trim ²
7	SENSE(+)	Positive remote sense ³
8	Vout(+)	Positive remote sense ³

Notes:

- SENSE(-) should be connected to Vout(-) either remotely or at the converter.
- Leave TRIM pin open for nominal output voltage.
- SENSE(+) should be connected to Vout(+) either remotely or at the converter.

Input: 35-75 V
Output: 12 V
Current: 17 A (200W)
Package: Quarter-brick

MECHANICAL DIAGRAM (base-plated)

Top View

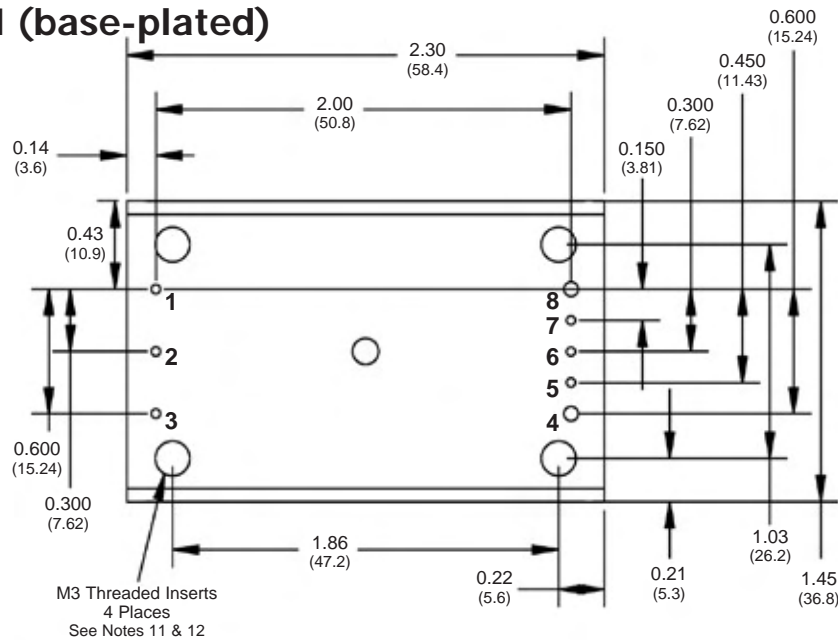

Side View

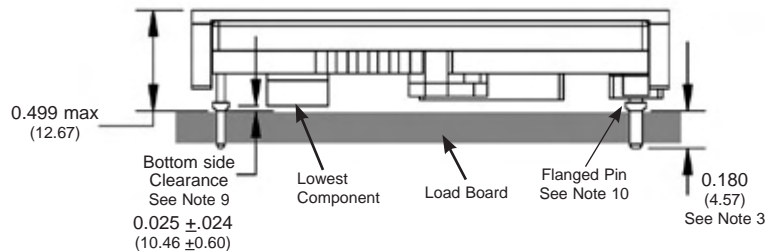

NOTES

PIN DESIGNATIONS

- 1) Pins 1-3, 5-7 are 0.040" (1.02mm) diameter with 0.080" (2.03 mm) diameter standoff shoulders.
- 2) Pins 4 and 8 are 0.062" (1.57 mm) diameter with 0.100" (2.54 mm) diameter standoff shoulders.
- 3) Other pin extension lengths available. Recommended pin length is 0.03" (0.76mm) greater than the PCB thickness.
- 4) All Pins: Material - Copper Alloy
 Finish (RoHS 5/6) - Tin/Lead over Nickel plate
 Finish (RoHS 6/6) - Matte Tin over Nickel plate
- 5) Undimensioned components are shown for visual reference only.
- 6) All dimensions in inches (mm)
 Tolerances: x.xx +0.02 in. (x.x +0.5mm)
 x.xxx +0.010 in. (x.xx +0.25mm)
- 7) Weight: 2.4 oz. (69 g) typical
- 8) Workmanship: Meets or exceeds IPC-A-610C Class II
- 9) UL/TUV standards require a clearance greater than 0.04" (1.02mm) between input and output for Basic insulation. This issue should be considered if any copper traces are on the top side of the user's board. Note that the ferrite cores are considered part of the input/primary circuit.
- 10) The flanged pins are designed to permit surface mount soldering (avoiding the wave soldering process) through the use of the flanged pin-in-paste technique.
- 11) M3 screws used to bolt unit's baseplate to other surfaces such as a heatsink must not exceed 0.100" (2.54mm) depth below the baseplate surface.
- 12) Applied torque per screw should not exceed 6 in-lb (0.7 Nm).

PIN	NAME	FUNCTION
1	Vin(+)	Positive input voltage
2	ON/OFF	TTL input to turn converter on and off, referenced to Vin(-), with internal pull up.
3	Vin(-)	Negative input voltage
4	Vout(-)	Negative output voltage
5	SENSE(-)	Negative remote sense ¹
6	TRIM	Output voltage trim ²
7	SENSE(+)	Positive remote sense ³
8	Vout(+)	Positive remote sense ³

Notes:

1. SENSE(-) should be connected to Vout(-) either remotely or at the converter.
2. Leave TRIM pin open for nominal output voltage.
3. SENSE(+) should be connected to Vout(+) either remotely or at the converter.

PQ60120QEA17 ELECTRICAL CHARACTERISTICS

Ta = 25°C, airflow rate = 300 LFM, Vin = 48 V dc unless otherwise noted; full operating temperature range is -40°C to +100 C baseplate temperature with appropriate power derating. Specifications subject to change without notice.

Parameter	Min.	Typ.	Max.	Units	Notes & Conditions
ABSOLUTE MAXIMUM RATINGS					
Input Voltage					
Non-Operating			100	V	Continuous
Operating			80	V	Continuous
Operating Transient Protection			100	V	100ms transient, square wave
Isolation Voltage					
Input to Output			2250	V dc	
Operating Temperature	-40		100	°C	
Storage Temperature	-55		125	°C	
Voltage at ON/OFF input pin	-2		18	V	
INPUT CHARACTERISTICS					
Operating Input Voltage Range	35	48	75	V	100V transient for 100ms
Input Under-Voltage Lockout					
Turn-On Voltage Threshold	31.5	33.0	34.5	V	
Turn-Off Voltage Threshold	28	29.5	31.0	V	
Lockout Voltage Hysteresis	2.5	3.5	4.5	V	
Maximum Input Current			7.0	A	100% Load, 35 Vin, trimmed up 5%
No-Load Input Current		90	120	mA	
Disabled Input Current		10	40	mA	
Response to Input Transient		1.5		V	0.25 V/μs input transient
Input Reflected Ripple Current		5	15	mA	RMS thru 4.7μH inductor
Input Terminal Ripple Current		150		mA	RMS
Recommended Input Fuse			12	A	Fast blow external fuse recommended
Input Filter Component Values (L\C)		3.3/3		μH\μF	Internal values; see Figure F (Lin\C2)
Recommended External Input Capacitance		100		μF	Typical ESR 0.1-0.2 Ω
OUTPUT CHARACTERISTICS					
Output Voltage Set Point	11.70	12.00	12.30	V	
Output Voltage Regulation					
Over Line		±1.0\120		%\mV	See Note 1
Over Load		±1.0\120		%\mV	See Note 1
Over Temperature		±100	±240	mV	
Total Output Voltage Range	11.58		12.42	V	Over sample, line, load, temperature & life
Output Voltage Ripple and Noise					500 MHz bandwidth; See Note 2
Peak-to-Peak		100	150	mV	Full load
RMS		20	40	mV	Full load
Operating Output Current Range	0		17	A	Subject to thermal derating
Output DC Current-Limit Inception	18	23	28	A	Output voltage 10% Low
Output DC Current-Limit Shutdown Voltage		5		V	See Note 3
Back-Drive Current Limit while Enabled	2	7	12	A	Negative current drawn from output source
Back-Drive Current Limit while Disabled	0	0.5	1	mA	Negative current drawn from output source
Maximum Output Capacitance Electrolytic			12	mF	12Vout at 17A Resistive Load

PQ60120QEA17 ELECTRICAL CHARACTERISTICS

Ta = 25°C, airflow rate = 300 LFM, Vin = 48 V dc unless otherwise noted; full operating temperature range is -40°C to +100°C baseplate temperature with appropriate power derating. Specifications subject to change without notice.

Parameter	Min.	Typ.	Max.	Units	Notes & Conditions
DYNAMIC CHARACTERISTICS					
Output Voltage during Load Current Transient					
Step Change in Output Current (0.1 A/μs)		500		mV	50% to 75% to 50% Iout max
Step Change in Output Current (5 A/μs)		500		mV	50% to 75% to 50% Iout max
Settling Time		1		ms	To within 1% Vout nom
Turn-On Transient					
Turn-On Time	24	27	30	ms	Full load, ON/OFF to Vout=90% nom.
Output Voltage Overshoot		2		%	Maximum Output Capacitance, Iout = 0A
EFFICIENCY					
100% Load	94	95		%	Figures 1 & 2
50% Load		96		%	Figures 1 & 2
ISOLATION CHARACTERISTICS					
Isolation Voltage (dielectric strength)		2250		V	
Isolation Resistance		30		MΩ	
Isolation Capacitance (input to output)		1000		pF	See Note 4
TEMPERATURE LIMITS FOR POWER DERATING CURVES					
Semiconductor Junction Temperature			125	°C	Package rated to 150°C
Board Temperature			125	°C	UL rated max operating temp 130°C
Transformer Temperature			125	°C	
FEATURE CHARACTERISTICS					
Switching Frequency Regulation Stage	235.6	238.0	240.4	kHz	Over sample, temp & life
Switching Frequency Isolation Stage	117.8	119.0	120.2	kHz	Over sample, temp & life
ON/OFF Control (Option P)					
Off-State Voltage	-2		1	V	
On-State Voltage	4		18	V	
ON/OFF Control (Option N)					
Off-State Voltage	4		18	V	
On-State Voltage	-2		1	V	
ON/OFF Control (Either Option)					Figures A & B
ON/OFF Control Hysteresis		1.5		V	
Pull-Up Voltage	4.75	5.00	5.25	V	
Pull-Up Resistance		10		kΩ	
Output Voltage Trim Range	-50		+5	%	Measured across Pins 8 & 4; see trim section
Output Over-Voltage Protection	113	118	123	%	Over full temp range; % of nominal Vout
Over-Temperature Shutdown		120		°C	Average PCB Temperature
Over-Temperature Shutdown Restart Hysteresis		10		°C	
RELIABILITY CHARACTERISTICS					
Calculated MTBF (Telcordia) TR-NWT-000332		TBD		10 ⁶ Hrs.	TR-NWT-000332; 80% load, 300LFM, 40°C Ta
Calculated MTBF (MIL-217) MIL-HDBK-217F		TBD		10 ⁶ Hrs.	MIL-HDBK-217F; 80% load, 300LFM, 40°C Ta
Field Demonstrated MTBF		TBD		10 ⁶ Hrs.	See website for details

Note 1: Line and load regulation is limited by duty cycle quantization and does not indicate a shift in the internal voltage reference.

Note 2: For applications requiring reduced output voltage ripple and noise, consult SynQor applications support (e-mail: support@synqor.com).

Note 3: If the output voltage falls below the Output DC Current Limit Shutdown Voltage for more than 50ms, then the unit will enter into hiccup mode, with a 500ms off-time.

Note 4: Higher values of isolation capacitance can be added external to the module.



Technical Specification

Input: 35-75 V
Output: 12 V
Current: 17 A (200W)
Package: Quarter-brick

PQ60120QEA17 STANDARDS COMPLIANCE and QUALIFICATION TESTING

Parameter	Notes & Conditions
STANDARDS COMPLIANCE	
UL 60950-1:2003	Basic Insulation
CAN/CSA-C22.2 No. 60950-1:2003	
EN60950-1:2001	
Needle Flame Test (IEC 695-2-2)	Test on entire assembly; board & plastic components UL94V-0 compliant
IEC 61000-4-2	ESD test, 8 kV - NP, 15 kV air - NP (Normal Performance)

Note: An external input fuse must always be used to meet these safety requirements. Contact SynQor for official safety certificates on new releases or download from the SynQor website.

Parameter	# Units	Test Conditions
QUALIFICATION TESTING		
Life Test	32	95% rated Vin and load, units at derating point, 1000 hours
Vibration	5	10-55 Hz sweep, 0.060" total excursion, 1 min./sweep, 120 sweeps for 3 axis
Mechanical Shock	5	100g minimum, 2 drops in x and y axis, 1 drop in z axis
Temperature Cycling	10	-40 °C to 100 °C, unit temp. ramp 15 °C/min., 500 cycles
Power/Thermal Cycling	5	Toperating = min to max, Vin = min to max, full load, 100 cycles
Design Marginality	5	Tmin-10 °C to Tmax+10 °C, 5 °C steps, Vin = min to max, 0-105% load
Humidity	5	85 °C, 85% RH, 1000 hours, continuous Vin applied except 5 min/day
Solderability	15 pins	MIL-STD-883, method 2003

Input: 35-75 V
Output: 12 V
Current: 17 A (200W)
Package: Quarter-brick

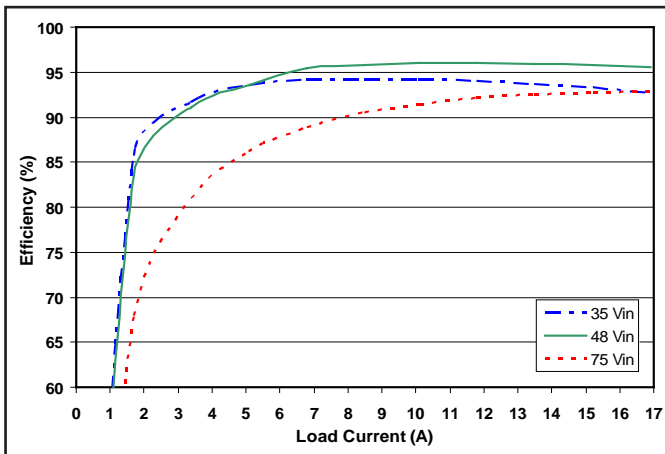

Figure 1: Efficiency at nominal output voltage vs. load current for minimum, nominal, and maximum input voltage at 25°C.

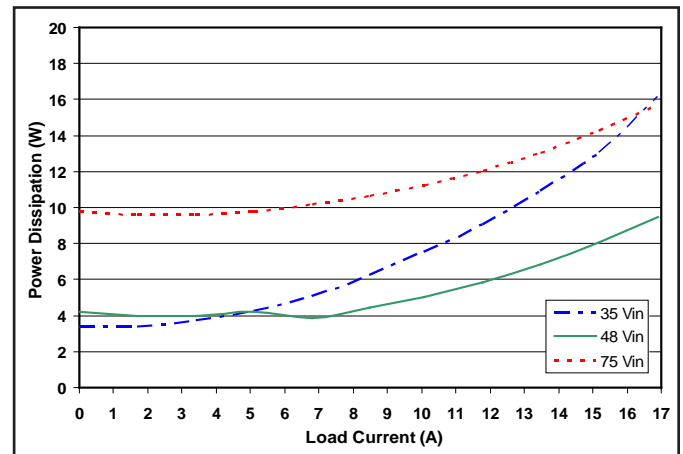

Figure 2: Power dissipation at nominal output voltage vs. load current for minimum, nominal, and maximum input voltage at 25°C.

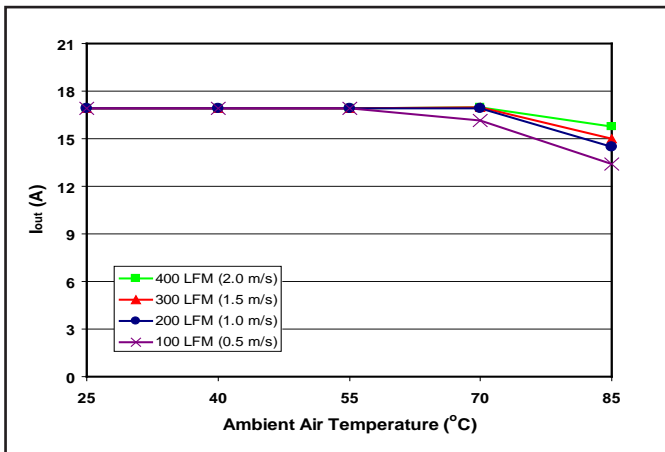

Figure 3: Maximum output power derating curves vs. ambient air temperature for airflow rates of 100 LFM through 400 LFM with air flowing across the converter from pin 1 to pin 3 (nominal input voltage).

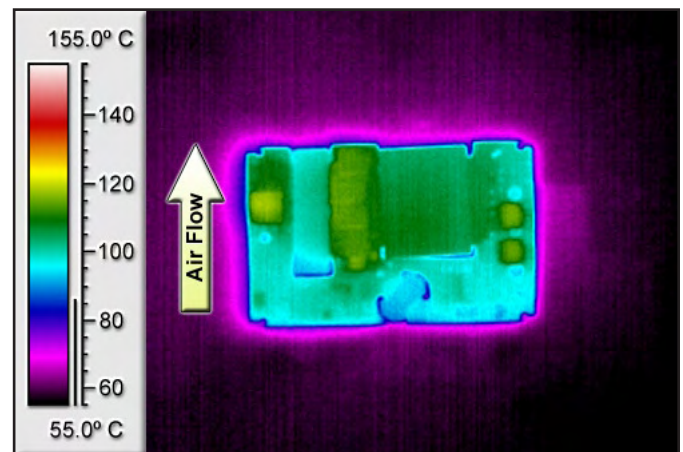

Figure 4: Thermal plot of converter at 17A load current (200W) with 55°C air flowing at the rate of 200 LFM. Air is flowing across the converter sideways from pin 1 to pin 3 (nominal input voltage).

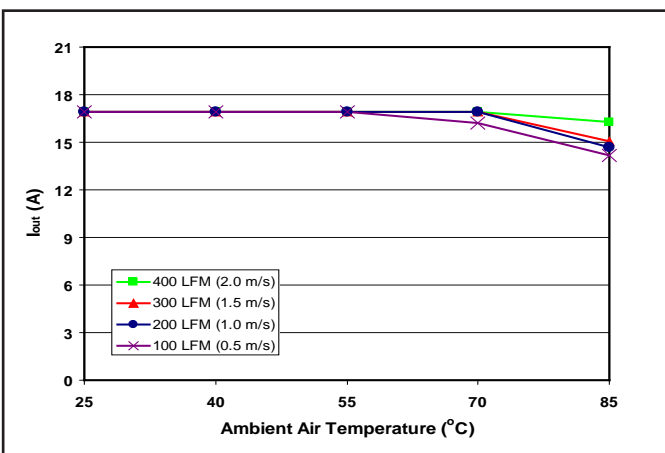

Figure 5: Maximum output power derating curves vs. ambient air temperature for airflow rates of 100 LFM through 400 LFM with air flowing lengthwise from input to output (nominal input voltage).

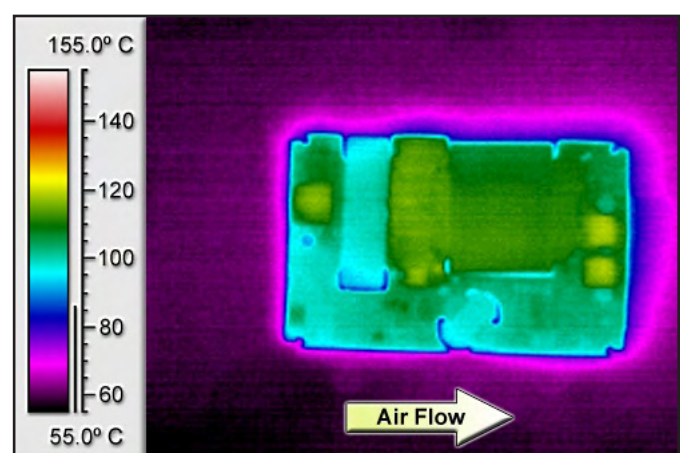

Figure 6: Thermal plot of converter at 17A load current (200 W) with 55°C air flowing at the rate of 200 LFM. Air is flowing across the converter from input to output (nominal input voltage).

Input: 35-75 V
Output: 12 V
Current: 17 A (200W)
Package: Quarter-brick

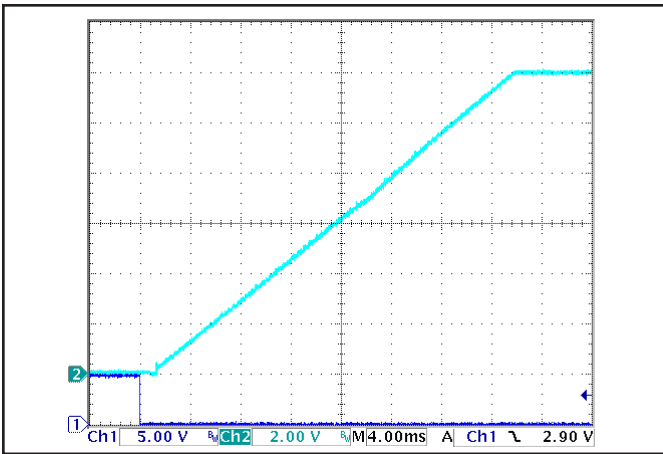

Figure 7: Turn-on transient at full load (resistive load) (4ms/div).
 Ch 1: ON/OFF input (5V/div)
 Ch 2: Vout (2V/div)

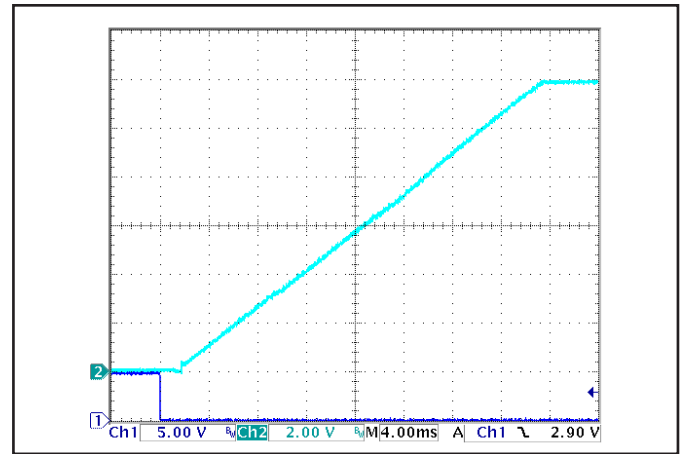

Figure 8: Turn-on transient at zero load (4ms/div). Ch 1: ON/OFF input (5V/div), Ch 2: Vout (2V/div)

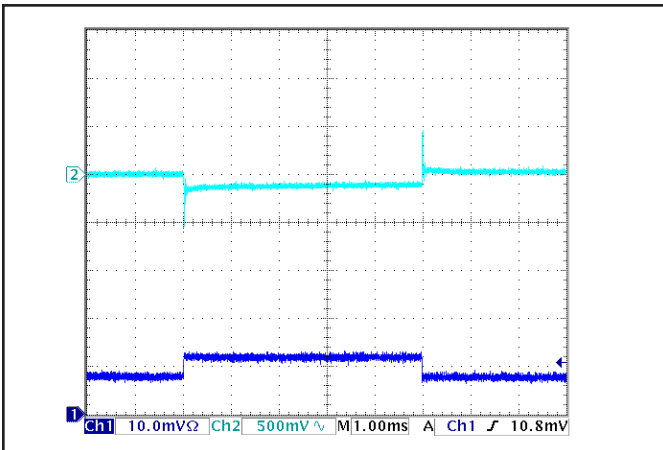

Figure 9: Output voltage response to step-change in load current (50%-75%-50% of $I_{out(max)}$; $dI/dt = 5A/\mu s$). Load cap: 1uF ceramic and 10uF tantalum capacitors. Top trace: Vout (500mV/div), Bottom trace: Iout (10A/div).

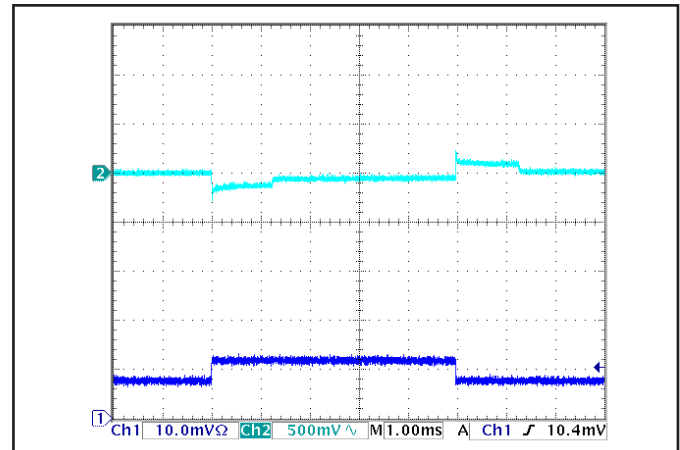

Figure 10: Output voltage response to step-change in load current (50%-75%-50% of $I_{out(max)}$; $dI/dt = 5A/\mu s$). Load cap: 470μF, 15 mΩ ESR tantalum capacitor. Top trace: Vout (500mV/div), Bottom trace: Iout (10A/div).

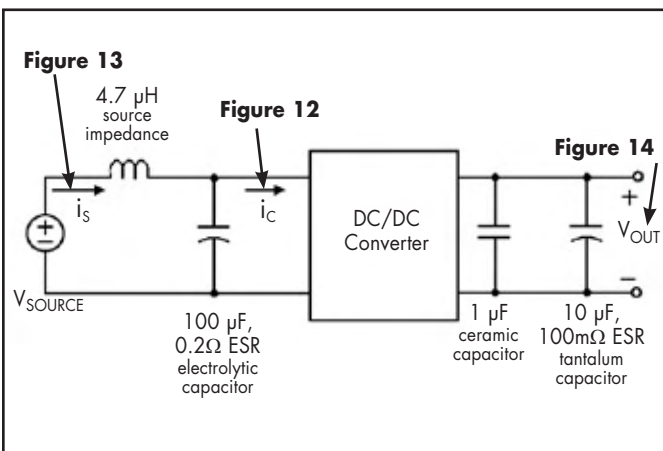

Figure 11: Test set-up diagram showing measurement points for Input Terminal Ripple Current (Figure 12), Input Reflected Ripple Current (Figure 13) and Output Voltage Ripple (Figure 14).

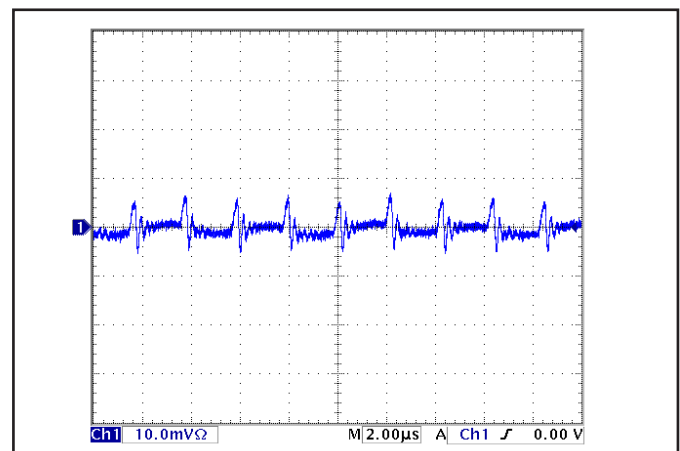

Figure 12: Input Terminal Ripple Current, i_c , at full rated output current and nominal input voltage with 4.7μH source impedance and 100μF electrolytic capacitor (100 mA/div). See Figure 11.

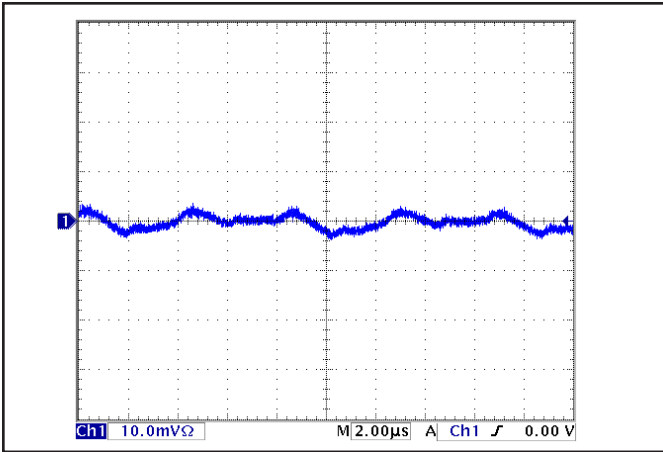

Figure 13: Input reflected ripple current, i_s , through a $4.7\mu\text{H}$ source inductor, using a $100\mu\text{F}$ input capacitor, at nominal input voltage and rated load current (10mA/div). See Figure 11.

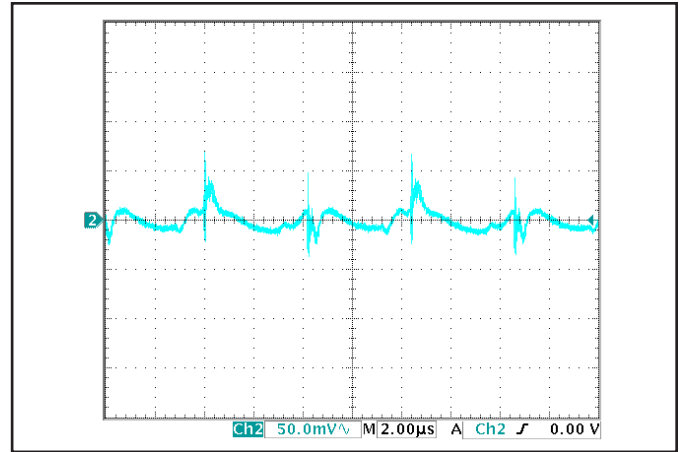

Figure 14: Output voltage ripple at nominal input voltage and rated load current (50mV/div). Load capacitance: $1\mu\text{F}$ ceramic capacitor and $10\mu\text{F}$ tantalum capacitor. Bandwidth: 500 MHz. See Figure 11.

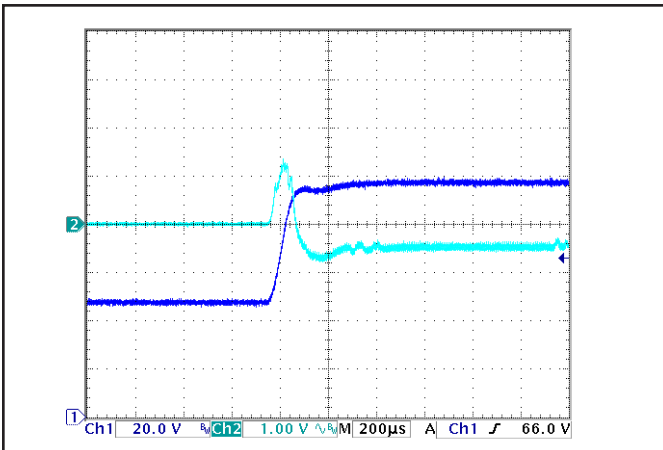

Figure 15: Output voltage response to step-change in input voltage (50V to 100V in $200\mu\text{s}$). Load cap: $470\mu\text{F}$, $15\text{ m}\Omega$ ESR tantalum capacitor. Ch 1: V_{in} (20V/div), Ch 2: V_{out} (1V/div), at zero load current.

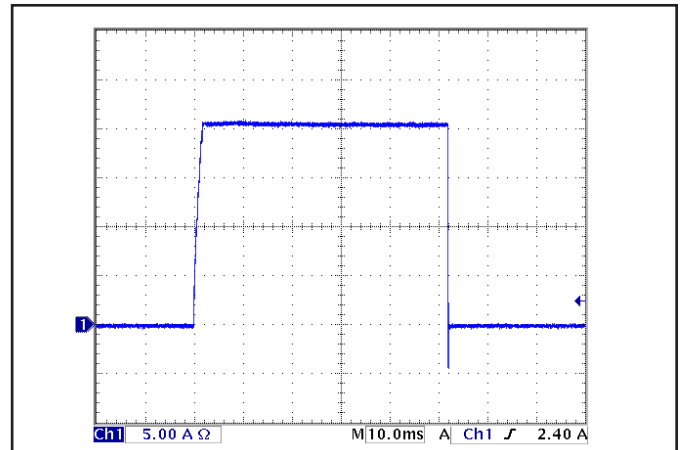

Figure 16: Load current (5A/div) as a function of time when the converter attempts to turn on into a $10\text{ m}\Omega$ short circuit.

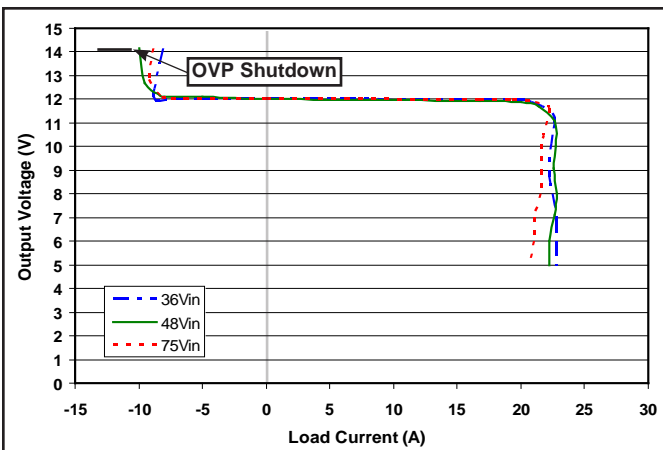

Figure 17: Output voltage vs. load current showing typical current limit curves and OVP shutdown point.

BASIC OPERATION AND FEATURES

The *PowerQor* Exa series converter uses a two-stage power conversion topology. The first stage keeps the output voltage constant over variations in line, load, and temperature. The second stage uses a transformer to provide the functions of input/output isolation and voltage step-down to achieve the low output voltage required.

Both the first stage and the second stage switch at a fixed frequency for predictable EMI performance. Rectification of the transformer's output is accomplished with synchronous rectifiers. These devices, which are MOSFETs with a very low on-state resistance, dissipate significantly less energy than Schottky diodes, enabling the *PowerQor* converter to achieve high efficiency.

Dissipation throughout the converter is so low that it does not require a heatsink for operation. Since a heatsink is not required, the *PowerQor* converter does not need a metal baseplate or potting material to help conduct the dissipated energy to the heatsink. As an open frame module, the *PowerQor* converter can be built more simply and reliably using high yield surface mount techniques on a PCB substrate.

The *PowerQor* series of half-brick, quarter-brick and eighth-brick converters uses the industry standard footprint and pin-out configuration.

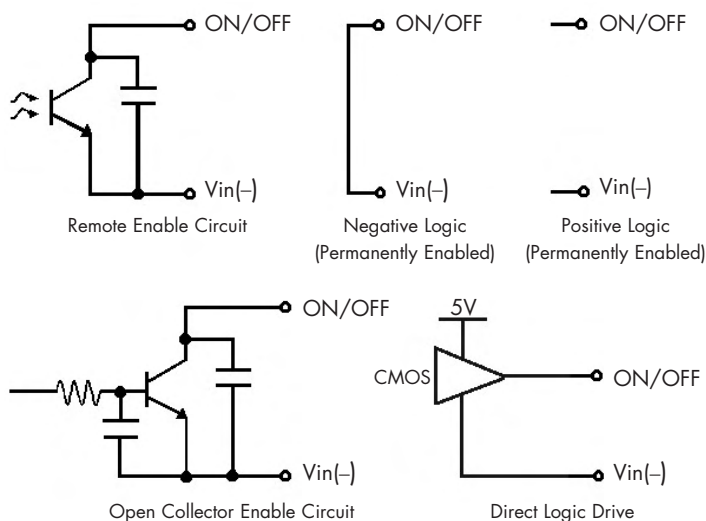

Figure A: Various circuits for driving the ON/OFF pin.

CONTROL FEATURES

REMOTE ON/OFF (Pin 2): The ON/OFF input, Pin 2, permits the user to control when the converter is *on* or *off*. This input is referenced to the return terminal of the input bus, Vin(-). The converter is available with either positive or negative logic used for the ON/OFF input.

In the positive logic version, the ON/OFF input is active high (meaning that a high voltage turns the converter *on*). In the negative logic version, the ON/OFF signal is active low (meaning that a low voltage turns the converter *on*). Figure A details five possible circuits for driving the ON/OFF pin.

REMOTE SENSE(±) (Pins 7 and 5): The SENSE(±) inputs correct for voltage drops along the conductors that connect the converter's output pins to the load.

Pin 7 should be connected to Vout(+) and Pin 5 should be connected to Vout(-) at the point on the board where regulation is desired. If these connections are not made, the converter will deliver an output voltage that is slightly higher than its specified value.

Note: The output over-voltage protection circuit senses the voltage across the sense leads (pins 7 and 5) to determine when it should trigger, not the voltage across the converter's output pins (pins 8 and 4).

OUTPUT VOLTAGE TRIM (Pin 6): The TRIM input permits the user to adjust the output voltage across the sense leads up or down according to the trim range specifications. SynQor uses industry standard trim equations.

To decrease the output voltage, the user should connect a resistor between Pin 6 (TRIM) and Pin 5 (SENSE(-) input). For a desired decrease of the nominal output voltage, the value of the resistor should be:

$$R_{\text{trim-down}} = \left(\frac{511}{\Delta\%} \right) - 10.22 \text{ k}\Omega$$

where

$$\Delta\% = \left| \frac{V_{\text{nominal}} - V_{\text{desired}}}{V_{\text{nominal}}} \right| \times 100\%$$

To increase the output voltage, the user should connect a resistor between Pin 6 (TRIM) and Pin 7 (SENSE(+)) input). For a desired increase of the nominal output voltage, the value of the resistor should be

$$R_{\text{trim-up}} = \left(\frac{5.11V_{\text{OUT}}(100+\Delta\%)}{1.225\Delta\%} - \frac{511}{\Delta\%} - 10.22 \right) (\text{k}\Omega)$$

where

V_{OUT} = Nominal Output Voltage

Figure B graphs the relationship between the trim resistor value, $R_{\text{trim-up}}$ and $R_{\text{trim-down}}$, showing the total range the output voltage can be trimmed up or down.

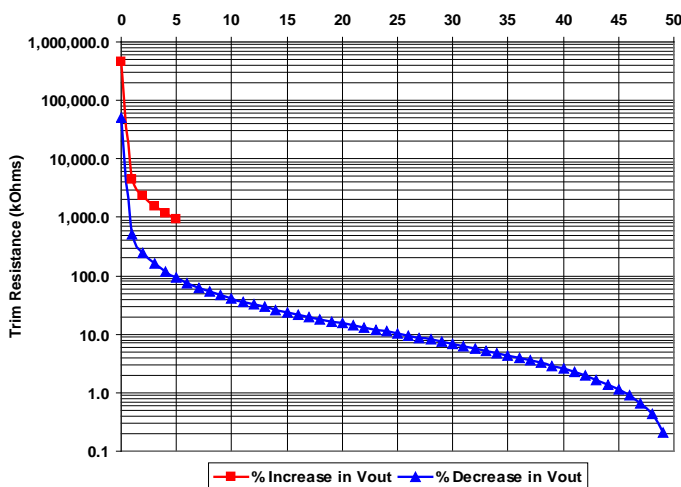

Figure B: Trim Graph for 12Vout module

Note: The TRIM feature does not affect the voltage at which the output over-voltage protection circuit is triggered. Trimming the output voltage too high may cause the over-voltage protection circuit to engage, particularly during transients.

It is not necessary for the user to add capacitance at the Trim pin. The node is internally filtered to eliminate noise.

Limited 10% up-trim: This converter is capable of operating for an indefinite period of time with the output trimmed up to 5% above the nominal 12V output level*. It may also be trimmed down by as much as 50% (to 6.0V) indefinitely.

This converter is also capable of being trimmed up by as much as 10% (up to 13.2V) for shorter periods of time that are not a significant fraction of the product lifetime. For example, in a test situation, or for output voltage margining where it would remain trimmed up between 5% and 10% of the nominal voltage for a

few hundred hours, but not for an indefinite period or the product lifetime. The OVP trip point is set above this level, so it will not shut down from output overvoltage protection when trimmed up between 5% and 10%. Continuous operation of this converter while trimmed up more than 5% could affect long term reliability.

Total DC Variation of Vout: For the converter to meet its full specifications, the maximum variation of the DC value of Vout, due to both trimming and remote load voltage drops, should not be greater than that specified for the output voltage trim range.

PROTECTION FEATURES

Input Under-Voltage Lockout: The converter is designed to turn off when the input voltage is too low, helping to avoid an input system instability problem, which is described in more detail in the application note titled "Input System Instability" on the SynQor website. The lockout circuitry is a comparator with DC hysteresis. When the input voltage is rising, it must exceed the typical "Turn-On Voltage Threshold" value* before the converter will turn on. Once the converter is on, the input voltage must fall below the typical Turn-Off Voltage Threshold value before the converter will turn off.

Output Current Limit: If the output current exceeds the "Output DC Current Limit Inception" point*, then a fast linear current limit controller will reduce the output voltage to maintain a constant output current. If as a result, the output voltage falls below the "Output DC Current Limit Shutdown Voltage"* for more than 50ms, then the unit will enter into hiccup mode, with a 500ms off-time. The unit will then automatically attempt to restart.

Back-Drive Current Limit: If there is negative output current of a magnitude larger than the "Back-Drive Current Limit while Enabled" specification*, then a fast back-drive limit controller will increase the output voltage to maintain a constant output current. If this results in the output voltage exceeding the "Output Over-Voltage Protection" threshold*, then the unit will shut down. The full I-V output characteristics can be seen in Figure 17.

Output Over-Voltage Limit: If the voltage directly across the output pins exceeds the "Output Over-Voltage Protection" threshold*, the converter will immediately stop switching. This shutdown is latching; unlike other shutdown types, the converter will not restart unless the input power is cycled or the ON/OFF input is toggled.

Over-Temperature Shutdown: A temperature sensor on the converter senses the average temperature of the module. The thermal shutdown circuit is designed to turn the converter off when the temperature at the sensed location reaches the "Over-Temperature Shutdown" value*. It will allow the converter to turn on again when the temperature of the sensed location falls by the amount of the "Over-Temperature Shutdown Restart Hysteresis" value*.

* See Electrical Characteristics page.

APPLICATION CONSIDERATIONS

Limited Output Voltage Resolution: The internal voltage control feedback loop has limited resolution. Therefore, the output voltage will exhibit discrete steps as the loop responds to changes in line, load, trim, or remote sense. For instance, on close examination, the startup ramp has a “stair-step” shape. Likewise, a load transient response will be composed of multiple discrete steps. The size of each step is well determined, and is shown in Figure C. A close-up picture of a single step is shown in Figure D. Stepping will not occur under steady state conditions.

Current share and active trim not recommended: It is important to note that external feedback control using the sense or trim pins will cause sustained stepping. External current share or active trim circuits contain a separate reference voltage. After this external feedback has taken control, the actual output voltage can still differ from the external reference voltage by as much as the step size. If the external feedback loop integrates this error voltage, it will cause a limit cycle oscillation. For this reason, external feedback using the sense and trim pins is not recommended.

Input System Instability: This condition can occur because any DC/DC converter appears incrementally as a negative resistance load. A detailed application note titled “Input System Instability” is available on the SynQor website which provides an understanding of why this instability arises, and shows the preferred solution for correcting it.

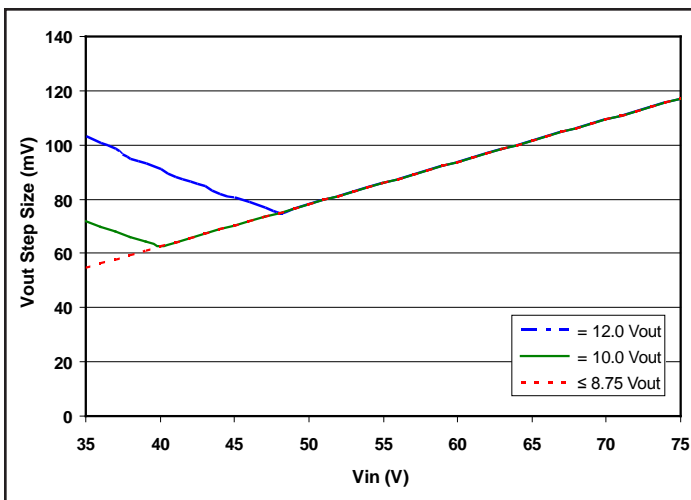

Figure C: Output voltage resolution.

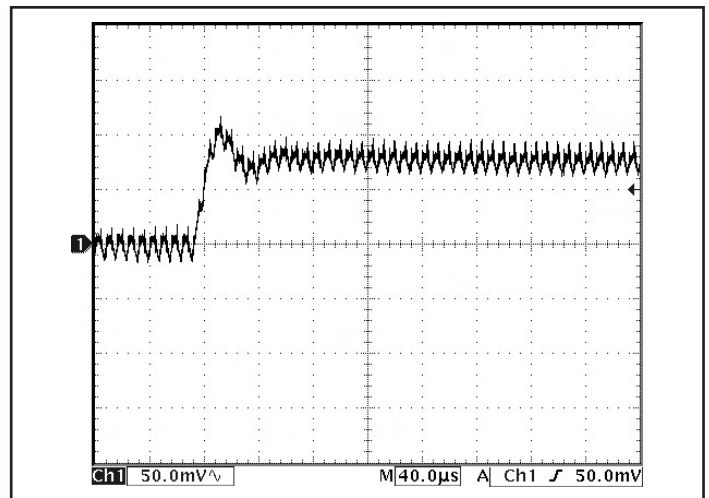

Figure D: Smallest possible Vout step at 48Vin and 12Vout.

* See Electrical Characteristics page.

Input: 35-75 V
Output: 12 V
Current: 17 A (200W)
Package: Quarter-brick

Application Circuits: Figure E below provides a typical circuit diagram which details the input filtering and voltage trimming.

Input Filtering and External Input Capacitance: Figure F below shows the internal input filter components. This filter dramatically reduces input terminal ripple current, which otherwise could exceed the rating of an external electrolytic input capacitor. The recommended external input capacitance is specified in the Input Characteristics section on the Electrical Specifications page. More detailed information is available in the application note titled "EMI Characteristics" on the SynQor website.

Output Filtering and External Output Capacitance: Figure F below shows the internal output filter components. This filter dramatically reduces output voltage ripple. However, some minimum external output capacitance is required, as specified in the Output Characteristics section on the Electrical Specifications page. No damage will occur without this capacitor connected, but peak output voltage ripple will be much higher.

RoHS Compliance: The EU led RoHS (Restriction of Hazardous Substances) Directive bans the use of Lead, Cadmium, Hexavalent Chromium, Mercury, Polybrominated Biphenyls (PBB), and Polybrominated Diphenyl Ether (PBDE) in Electrical and Electronic Equipment. This SynQor product is available as 5/6 RoHS compliant (product with lead) or 6/6 RoHS compliant. For more information please refer to SynQor's RoHS addendum available at our RoHS Compliance / Lead Free Initiative web page or e-mail us at rohs@synqor.com.

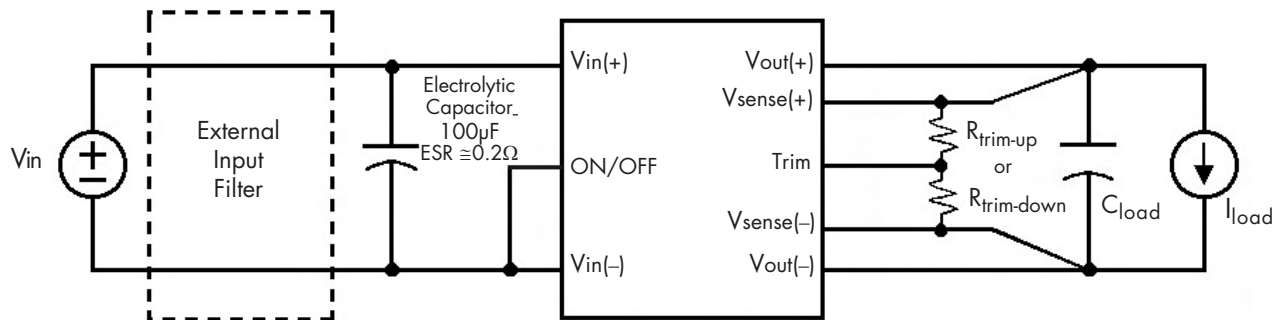

Figure E: Typical application circuit (negative logic unit, permanently enabled).

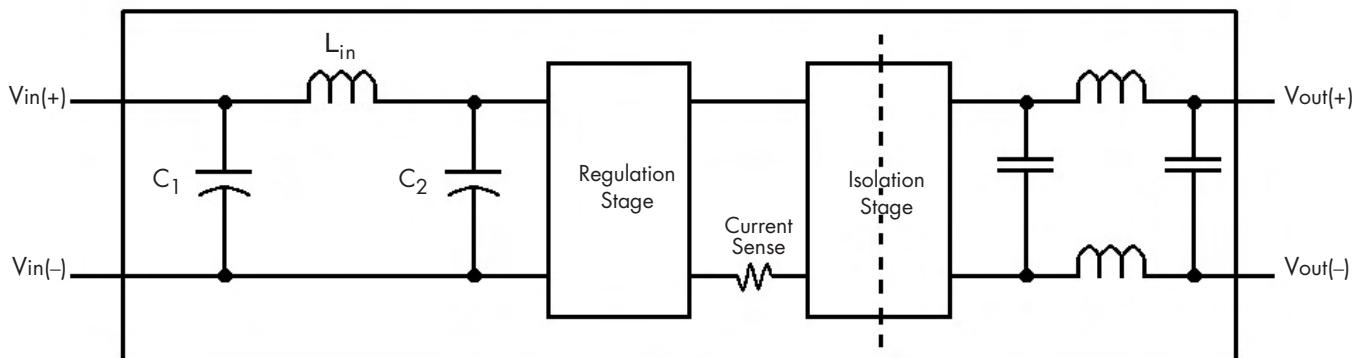

Figure F: Internal Input and Output Filter Diagram (component values listed on specifications page).



Technical Specification

Input: 35-75 V
Output: 12 V
Current: 17 A (200W)
Package: Quarter-brick

PART NUMBERING SYSTEM

The part numbering system for SynQor's NiQor dc-dc converters follows the format shown in the example below.

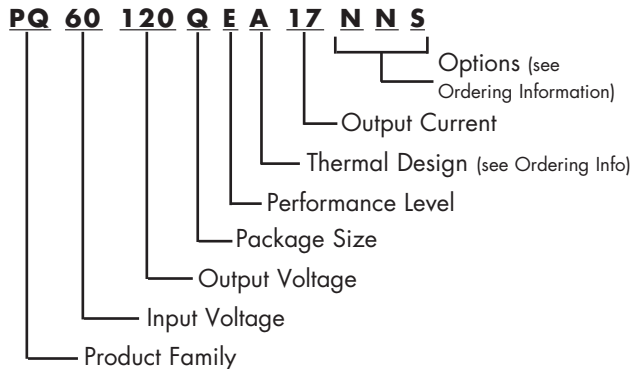

The first 12 characters comprise the base part number and the last 3 characters indicate available options. Although there are no default values for enable logic and pin length, the most common options are negative logic and 0.145" pins. These part numbers are more likely to be readily available in stock for evaluation and prototype quantities. A "-G" suffix indicates 6/6 RoHS compliance.

Application Notes

A variety of application notes and technical white papers can be downloaded in pdf format from our website.

PATENTS

SynQor holds the following patents, one or more of which might apply to this product:

5,999,417	6,222,742	6,545,890	6,577,109
6,594,159	6,731,520	6,894,468	6,896,526
6,927,987	7,050,309	7,072,190	7,085,146
7,119,524	7,269,034	7,272,021	7,272,023

Contact SynQor for further information:

Phone: 978-849-0600
Toll Free: 888-567-9596
Fax: 978-849-0602
E-mail: power@synqor.com
Web: www.synqor.com
Address: 155 Swanson Road
 Boxborough, MA 01719
 USA

ORDERING INFORMATION

The tables below show the valid model numbers and ordering options for converters in this product family. When ordering SynQor converters, please ensure that you use the complete 15 character part number consisting of the 12 character base part number and the additional characters for options. A "-G" suffix indicates the product is 6/6 RoHS compliant.

Model Number	Input Voltage	Output Voltage	Max Output Current
PQ60120QEw17xyz	35-75 V	12 V	17A

The following options must be included in place of the **w x y z** spaces in the model numbers listed above.

Options Description: w x y z			
Thermal Design	Enable Logic	Pin Style	Feature Set
A - Open Frame B - Baseplated	P - Positive N - Negative	K - 0.110" N - 0.145" R - 0.180" Y - 0.250"	S - Standard

RoHS Compliance: The EU led RoHS (Restriction of Hazardous Substances) Directive bans the use of Lead, Cadmium, Hexavalent Chromium, Mercury, Polybrominated Biphenyls (PBB), and Polybrominated Diphenyl Ether (PBDE) in Electrical and Electronic Equipment. This SynQor product is 6/6 RoHS compliant. For more information please refer to SynQor's RoHS addendum available at our [RoHS Compliance / Lead Free Initiative web page](#) or e-mail us at rohs@synqor.com.

Warranty

SynQor offers a three (3) year limited warranty. Complete warranty information is listed on our website or is available upon request from SynQor.

Information furnished by SynQor is believed to be accurate and reliable. However, no responsibility is assumed by SynQor for its use, nor for any infringements of patents or other rights of third parties which may result from its use. No license is granted by implication or otherwise under any patent or patent rights of SynQor.