

## NPN power TRILINTON™

### Features

- Integrated high voltage active clamping Zener
- Clamping energy capability 100% tested
- Very high current gain

### Applications

- Engine ignition control
- Switching regulators
- Motor control
- Light ballast

### Description

The STD37N05TZ is a planar, monolithic, high voltage power TRILINTON™ with a built-in active Zener clamping circuit. This device has been specifically designed for unclamped, inductive applications such as ignition systems, switching regulators, and wherever high voltage and high robustness is required.

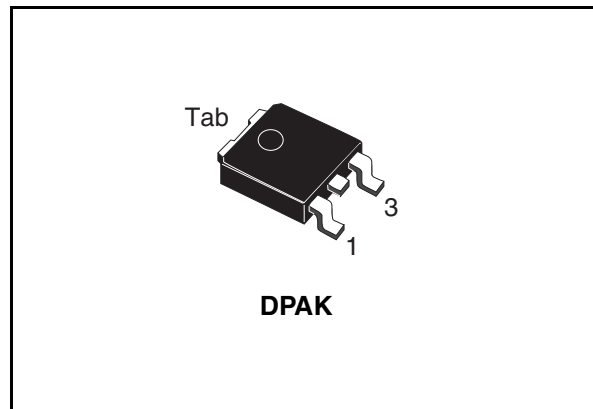

Figure 1. Internal schematic diagram

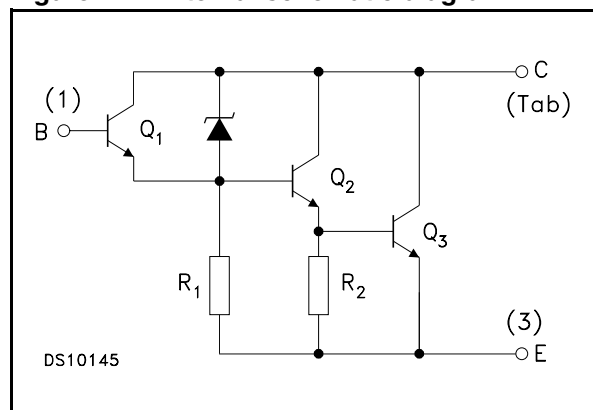

Table 1. Device summary

Order code	Marking	Package	Packaging
STD37N05TZT4	D37N05TZ	DPAK	Tape and reel

# 1 Electrical ratings

**Table 2. Absolute maximum rating**

Symbol	Parameter	Value	Unit
$V_{CES}$	Collector-emitter voltage ( $V_{BE} = 0$ )	370	V
$V_{EBO}$	Emitter-base voltage ( $I_C = 0$ )	13	V
$I_C$	Collector current	5	A
$I_{CM}$	Collector peak current ( $t_P < 5$ ms)	8	A
$I_B$	Base current	1	A
$P_{tot}$	Total dissipation at $T_C = 25$ °C	45	W
$T_{stg}$	Storage temperature	-65 to 150	°C
$T_J$	Max. operating junction temperature	150	°C

**Table 3. Thermal data**

Symbol	Parameter	Value	Unit
$R_{thj-case}$	Thermal resistance junction-case	2.78	°C/W
$R_{thj-amb}$	Thermal resistance junction-ambient	72	°C/W

## 2 Electrical characteristics

( $T_{\text{case}} = 25^{\circ}\text{C}$  unless otherwise specified)

**Table 4. Electrical characteristics**

Symbol	Parameter	Test conditions	Min.	Typ.	Max.	Unit
$I_{\text{EBO}}$	Emitter cut-off current ( $I_{\text{C}} = 0$ )	$V_{\text{EB}} = 13 \text{ V}$			100	$\mu\text{A}$
$I_{\text{CES}}$	Collector cut-off current ( $V_{\text{BE}} = 0$ )	$V_{\text{CE}} = 370 \text{ V}$			100	$\mu\text{A}$
$V_{(\text{BR})\text{CES}}$	Collector-emitter breakdown voltage ( $V_{\text{BE}} = 0$ )	$I_{\text{C}} = 50 \text{ mA}$	370		660	V
$V_{\text{CE}(\text{sat})}^{(1)}$	Collector-emitter saturation voltage	$I_{\text{C}} = 2.5 \text{ A}$ $I_{\text{B}} = 1 \text{ mA}$			4	V
		$I_{\text{C}} = 3 \text{ A}$ $I_{\text{B}} = 3 \text{ mA}$			4	V
$V_{\text{BE}(\text{sat})}^{(1)}$	Base-emitter saturation voltage	$I_{\text{C}} = 3 \text{ A}$ $I_{\text{B}} = 3 \text{ mA}$			3.5	V
$h_{\text{FE}}$	DC current gain	$I_{\text{C}} = 1 \text{ A}$ $V_{\text{CE}} = 5 \text{ V}$	7000			
$E_{\text{s/b}}^{(1)}$	Secondary breakdown energy	$I_{\text{C}} = 4 \text{ A}$ $L = 10 \text{ mH}$	80			mJ

1. Pulsed duration = 300 ms, duty cycle  $\leq 1.5\%$

## 2.1 Electrical characteristics (curves)

Figure 2. DC current gain

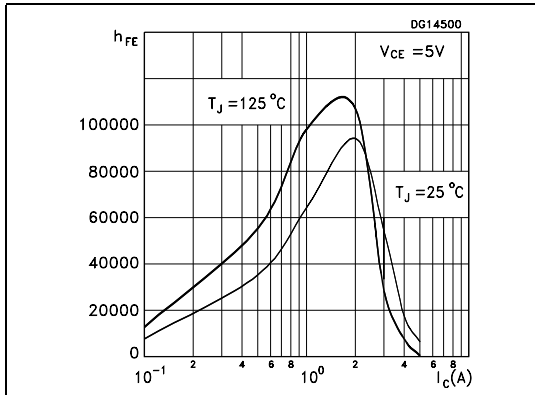

Figure 3. Collector-emitter saturation voltage

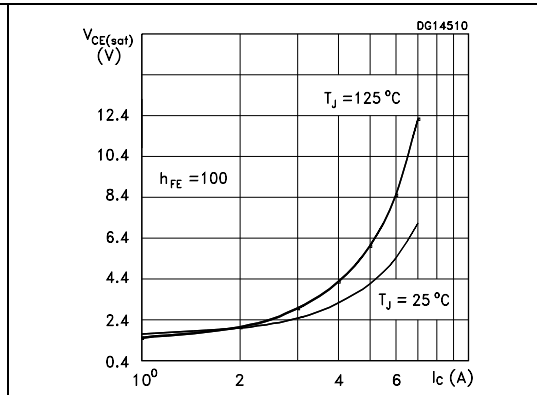

Figure 4. Collector-emitter saturation voltage

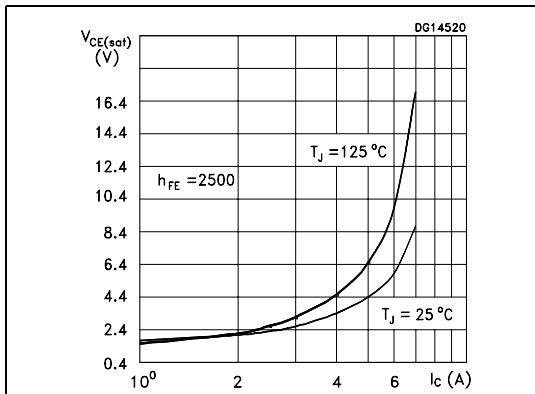
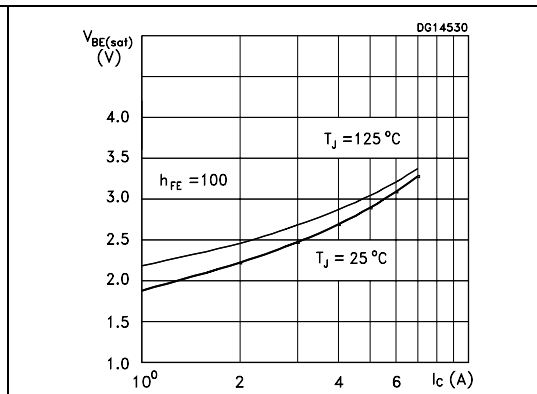

Figure 5. Base-emitter saturation voltage



### 3 Package mechanical data

In order to meet environmental requirements, ST offers these devices in ECOPACK® packages. These packages have a lead-free second level interconnect. The category of second level interconnect is marked on the package and on the inner box label, in compliance with JEDEC Standard JESD97. The maximum ratings related to soldering conditions are also marked on the inner box label. ECOPACK is an ST trademark. ECOPACK specifications are available at: [www.st.com](http://www.st.com)

**TO-252 (DPAK) mechanical data**

DIM.	mm.		
	min.	typ	max.
A	2.20		2.40
A1	0.90		1.10
A2	0.03		0.23
b	0.64		0.90
b4	5.20		5.40
c	0.45		0.60
c2	0.48		0.60
D	6.00		6.20
D1		5.10	
E	6.40		6.60
E1		4.70	
e		2.28	
e1	4.40		4.60
H	9.35		10.10
L	1		
L1		2.80	
L2		0.80	
L4	0.60		1
R		0.20	
V2	0°		8°

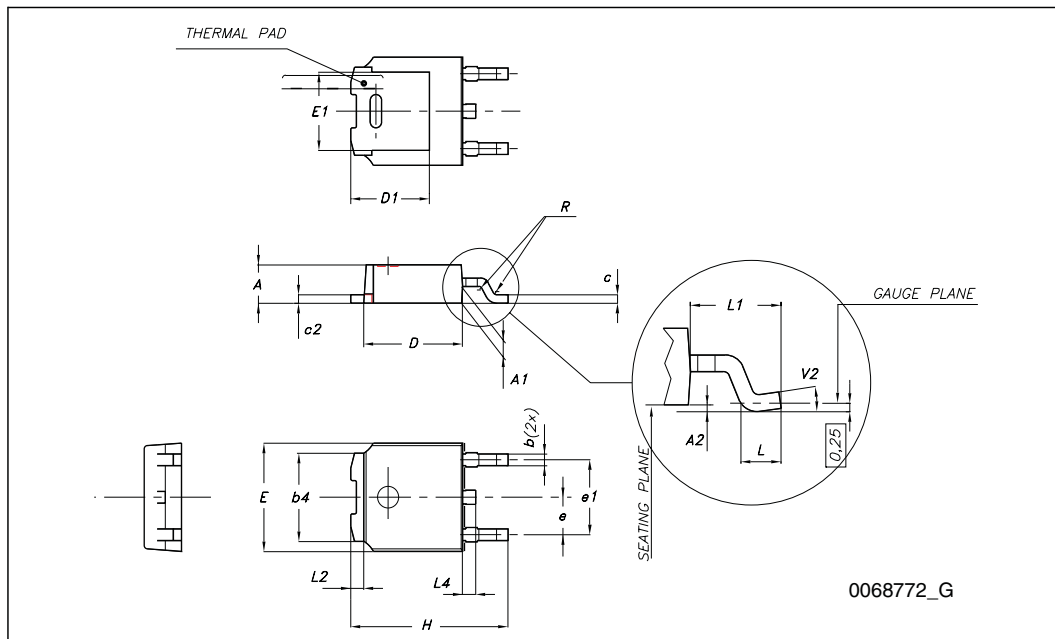

## 4 Revision history

**Table 5. Document revision history**

Date	Revision	Changes
02-Aug-2007	1	First release.
07-Aug-2007	2	Updated marking on <a href="#">Table 1</a>
09-Jun-2008	3	Updated internal schematic diagram, <a href="#">Figure 1</a> .

**Please Read Carefully:**

Information in this document is provided solely in connection with ST products. STMicroelectronics NV and its subsidiaries ("ST") reserve the right to make changes, corrections, modifications or improvements, to this document, and the products and services described herein at any time, without notice.

All ST products are sold pursuant to ST's terms and conditions of sale.

Purchasers are solely responsible for the choice, selection and use of the ST products and services described herein, and ST assumes no liability whatsoever relating to the choice, selection or use of the ST products and services described herein.

No license, express or implied, by estoppel or otherwise, to any intellectual property rights is granted under this document. If any part of this document refers to any third party products or services it shall not be deemed a license grant by ST for the use of such third party products or services, or any intellectual property contained therein or considered as a warranty covering the use in any manner whatsoever of such third party products or services or any intellectual property contained therein.

**UNLESS OTHERWISE SET FORTH IN ST'S TERMS AND CONDITIONS OF SALE ST DISCLAIMS ANY EXPRESS OR IMPLIED WARRANTY WITH RESPECT TO THE USE AND/OR SALE OF ST PRODUCTS INCLUDING WITHOUT LIMITATION IMPLIED WARRANTIES OF MERCHANTABILITY, FITNESS FOR A PARTICULAR PURPOSE (AND THEIR EQUIVALENTS UNDER THE LAWS OF ANY JURISDICTION), OR INFRINGEMENT OF ANY PATENT, COPYRIGHT OR OTHER INTELLECTUAL PROPERTY RIGHT.**

**UNLESS EXPRESSLY APPROVED IN WRITING BY AN AUTHORIZED REPRESENTATIVE OF ST, ST PRODUCTS ARE NOT RECOMMENDED, AUTHORIZED OR WARRANTED FOR USE IN MILITARY, AIR CRAFT, SPACE, LIFE SAVING, OR LIFE SUSTAINING APPLICATIONS, NOR IN PRODUCTS OR SYSTEMS, WHERE FAILURE OR MALFUNCTION MAY RESULT IN PERSONAL INJURY, DEATH, OR SEVERE PROPERTY OR ENVIRONMENTAL DAMAGE. ST PRODUCTS WHICH ARE NOT SPECIFIED AS "AUTOMOTIVE GRADE" MAY ONLY BE USED IN AUTOMOTIVE APPLICATIONS AT USER'S OWN RISK.**

Resale of ST products with provisions different from the statements and/or technical features set forth in this document shall immediately void any warranty granted by ST for the ST product or service described herein and shall not create or extend in any manner whatsoever, any liability of ST.

ST and the ST logo are trademarks or registered trademarks of ST in various countries.

Information in this document supersedes and replaces all information previously supplied.

The ST logo is a registered trademark of STMicroelectronics. All other names are the property of their respective owners.

© 2008 STMicroelectronics - All rights reserved

STMicroelectronics group of companies

Australia - Belgium - Brazil - Canada - China - Czech Republic - Finland - France - Germany - Hong Kong - India - Israel - Italy - Japan - Malaysia - Malta - Morocco - Singapore - Spain - Sweden - Switzerland - United Kingdom - United States of America

[www.st.com](http://www.st.com)