



TAI-SAW TECHNOLOGY CO., LTD.

No. 3, Industrial 2nd Rd., Ping-Chen Industrial District,
Taoyuan, 324, Taiwan, R.O.C.

TEL: 886-3-4690038 FAX: 886-3-4697532

E-mail: tstsales@mail.taisaw.com Web: www.taisaw.com

Product Specifications Approval Sheet

Product Description: SAW Filter 1620.75 MHz SMD 3.0X3.0 mm

TST Part No.: TA1101A

Customer Part No.: _____

Customer signature required
Company: _____
Division: _____
Approved by : _____
Date: _____

Checked by: _____ Bob Chau *Bob Chau*

Approved by: _____ Francis Chen *Francis Chen*

Date: _____ 9, 24, 2009

1. Customer signed back is required before TST can proceed with sample build and receive orders.
2. Orders received without customer signed back will be regarded as agreement on the specifications.
3. Any specifications changes must be approved upon by both parties and a new revision of specifications shall be released to reflect the changes.



TAI-SAW TECHNOLOGY CO., LTD.

No. 3, Industrial 2nd Rd., Ping-Chen Industrial District,
Taoyuan, 324, Taiwan, R.O.C.

TEL: 886-3-4690038 FAX: 886-3-4697532

E-mail: tstsales@mail.taisaw.com Web: www.taisaw.com

SAW Filter 1620.75 MHz

MODEL NO.:TA1101A

REV. NO.:1

A. MAXIMUM RATING:

1. Input Power Level: +5 dBm
2. DC Voltage : 3V
3. Operating Temperature: -20°C to +70°C
4. Storage Temperature: -40°C to +85°C

RoHS Compliant
Lead free
Lead-free soldering

B. ELECTRICAL CHARACTERISTICS:

Item	Unit	Min.	Type.	Max.	Note
Center Frequency Fc	MHz	-	1620.75	-	-
Insertion Loss (1615~1626.5 MHz) IL	dB	-	1.3	2.8	-
Amplitude Ripple (1615~1626.5 MHz)	dB	-	0.3	1.8	-
Attenuation (Reference level from 0 dB)					
1100 ~ 1400 MHz	dB	30	35	-	-
1400 ~ 1560 MHz	dB	30	37	-	-
1680 ~ 1825 MHz	dB	30	40	-	-
1825 ~ 1900 MHz	dB	35	40	-	-

C. MEASUREMENT CIRCUIT:

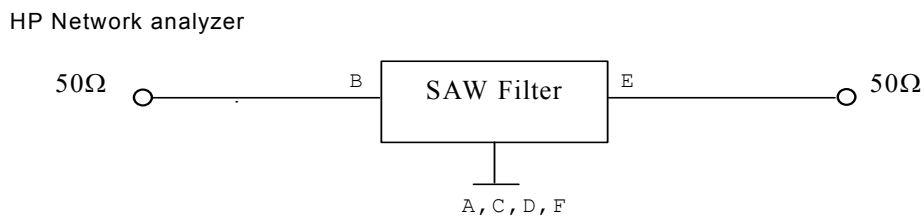

D.OUTLINE DRAWING:

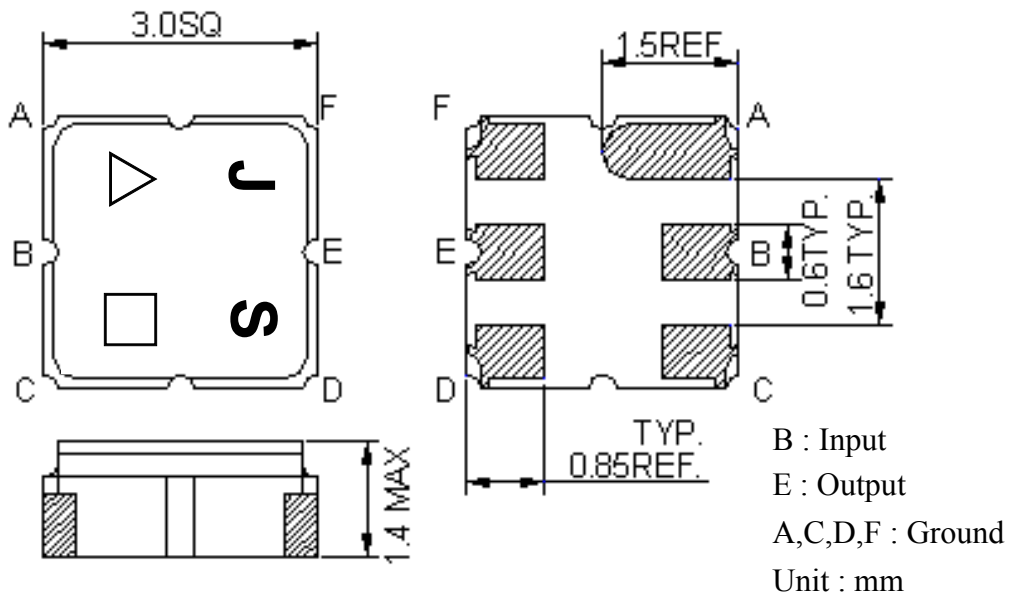

△ : Year Code (2006->6, ..., 2009->9)

□ : Date Code (W01->A, W02->B, ..., W27->a, ..., W52->z)

E. PCB Footprint:

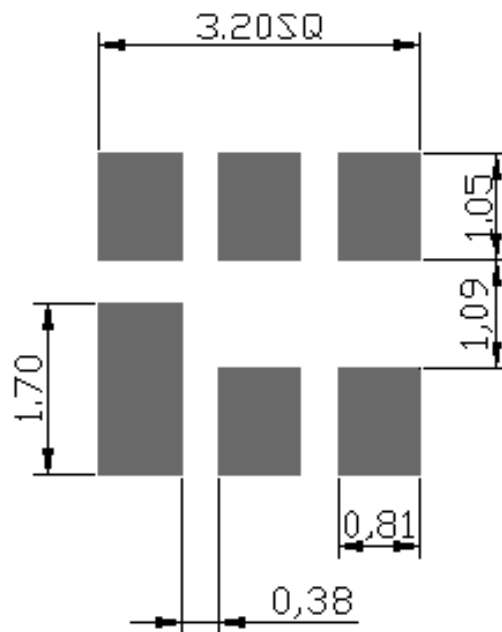

F. Frequency Characteristics :

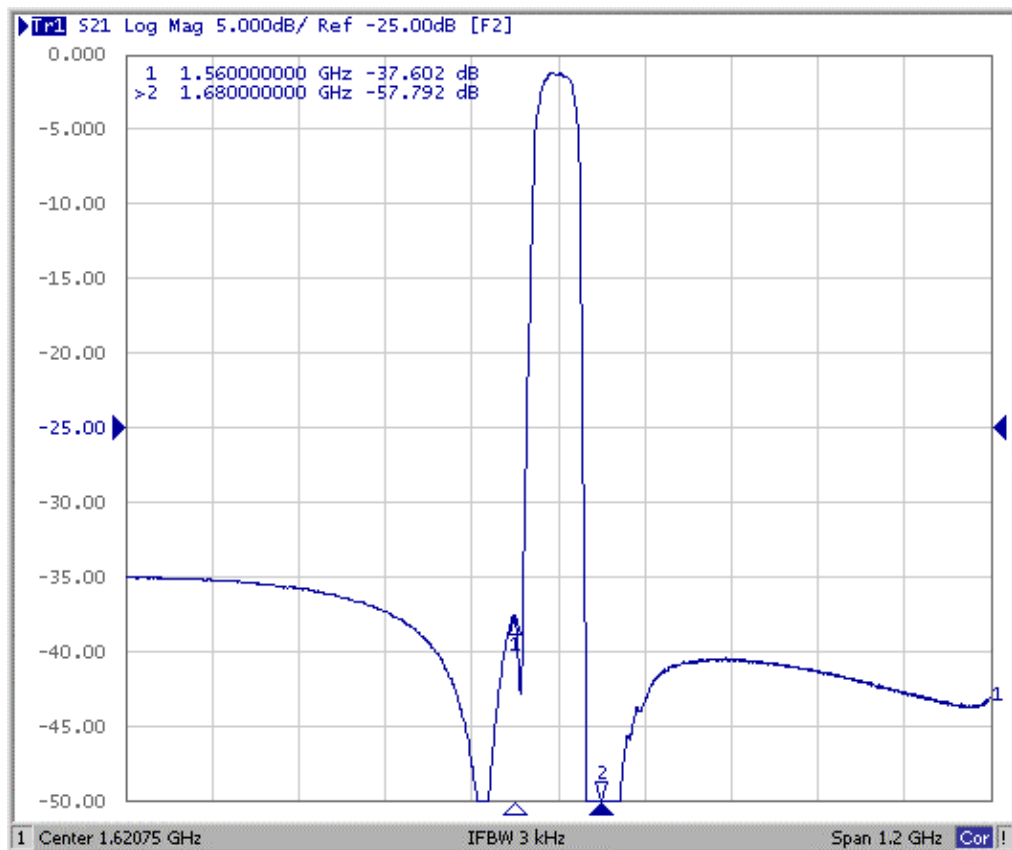
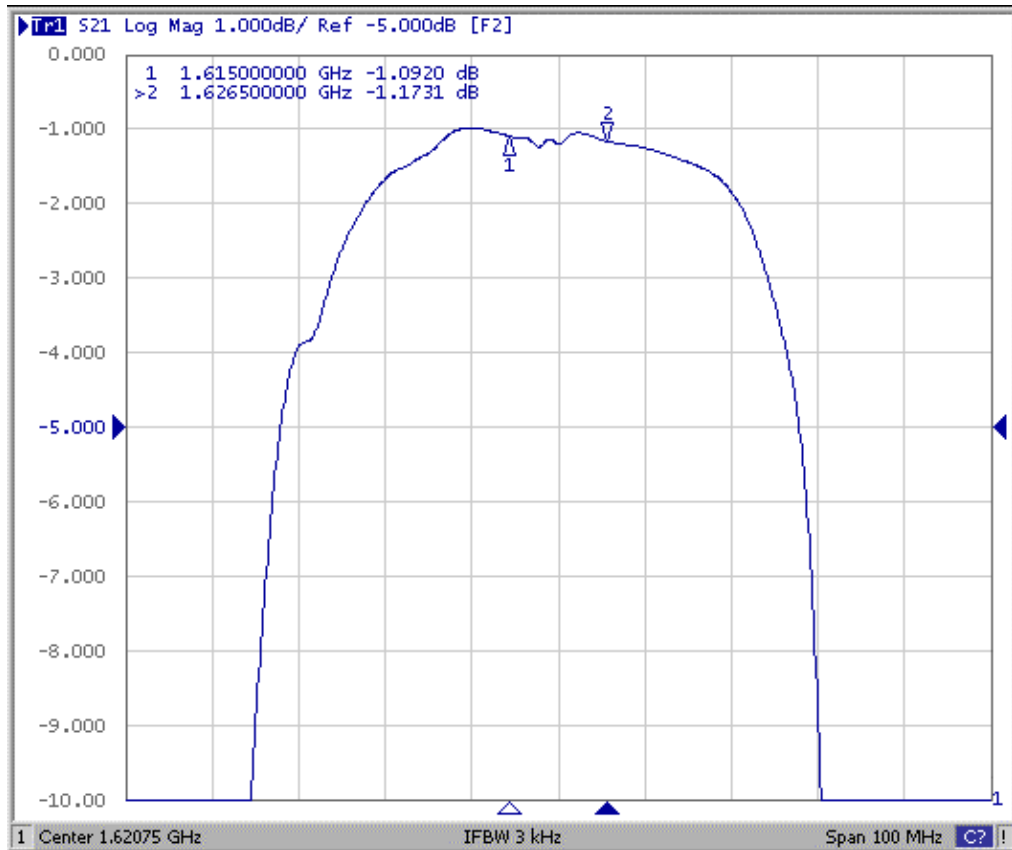

Reflection Functions :

S11

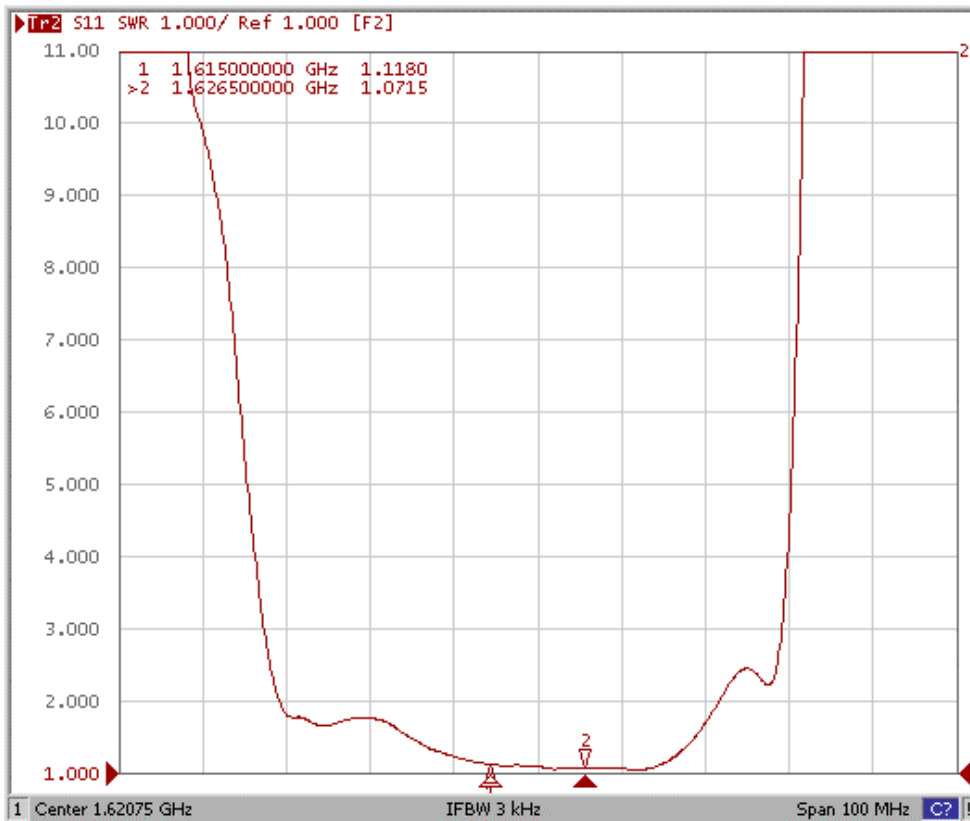

S22

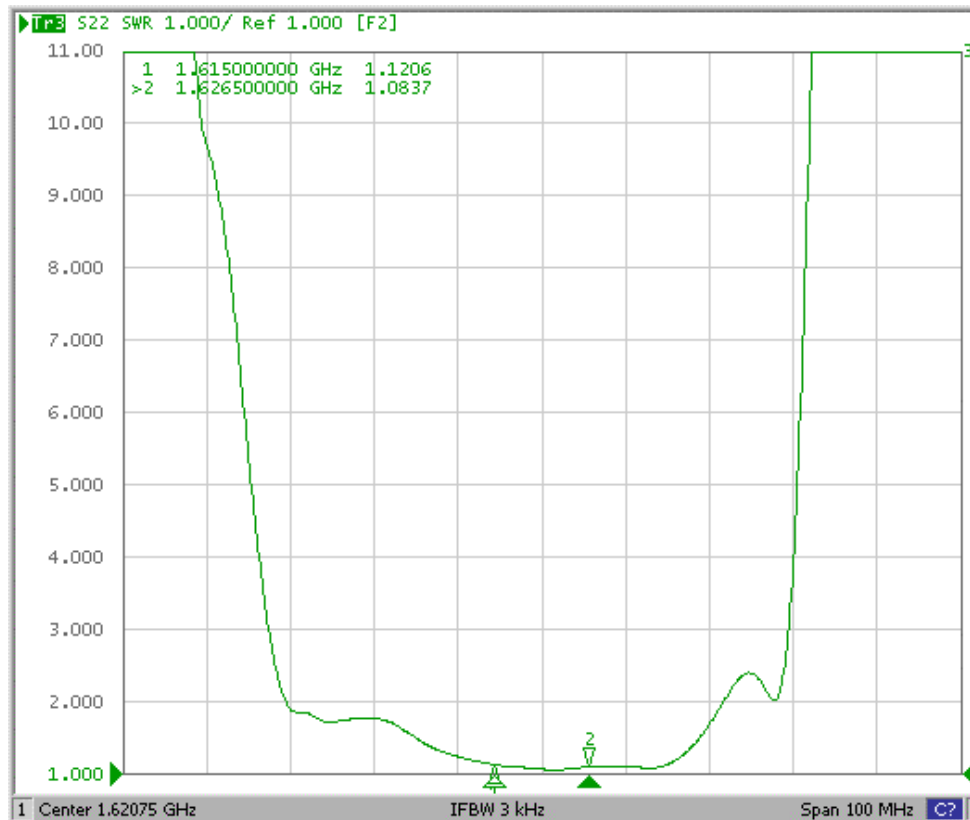

G. PACKING:

1. REEL DIMENSION

(Reel Count : 7"=1000 ; 13"=3000)



2. TAPE DIMENSION

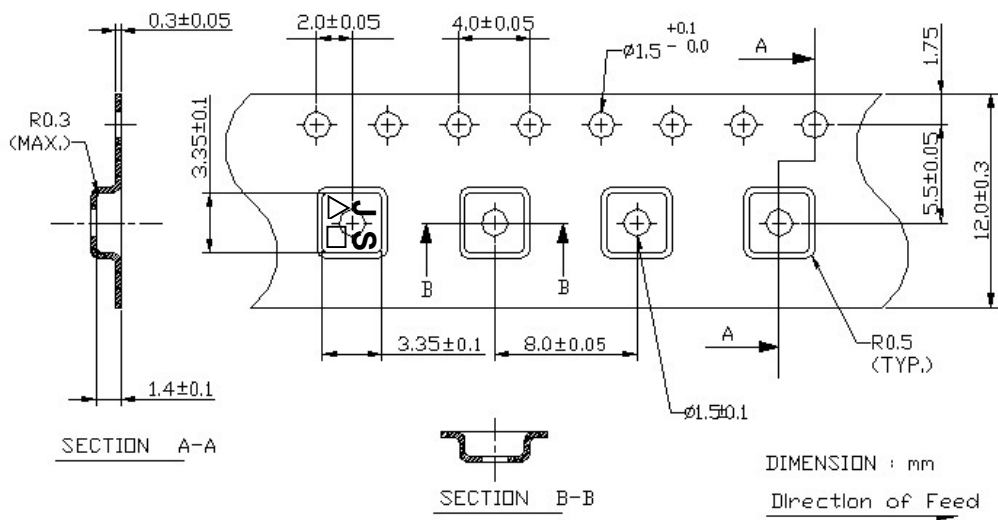

H. RECOMMENDED REFLOW PROFILE :

