

3W Stereo Fully Differential Audio Power Amplifier

Features

- **Operating Voltage: 2.4V~5.5V**
- **Fully Differential Class-AB Amplifier**
- **High PSRR and Excellent RF Rectification Immunity**
- **Low Crosstalk**
- **3W Per Channel Output Power into 3W Load at $V_{DD}=5V$**
- **Thermal and Over-Current Protections**
- **Built-in Feedback Resistors Eliminate External Components Counts**
- **Space Saving Package**
– TQFN5x5-20A
- **Lead Free and Green Devices Available (RoHS Compliant)**

Applications

- LCD TVs
- Notebook, PCs
- Portable Devices

Simplified Application Circuit

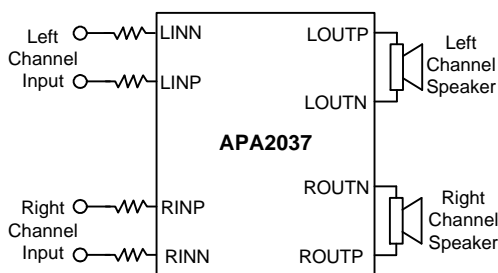

General Description

The APA2037 is a stereo, fully differential Class-AB audio amplifier which can operate with supply voltage from 2.4V to 5V and is available in a TQFN5x5-20A package.

The built-in feedback resistors can minimize the external component counts and save the PCB space. High PSRR and fully differential architecture increase immunity to noise and RF rectification. In addition to these features, a short startup time and small package size make the APA2037 is an ideal choice for LCD TVs and notebook PCs and Portable devices.

The APA2037 also integrates the de-pop circuitry that reduces the pops and click noises during power on/off and shutdown mode operation. Both Thermal and over-current protections are integrated to avoid the IC to be destroyed by over temperature and short-circuit.

The APA2037 is capable of driving 3W at 5V into 3Ω speaker.

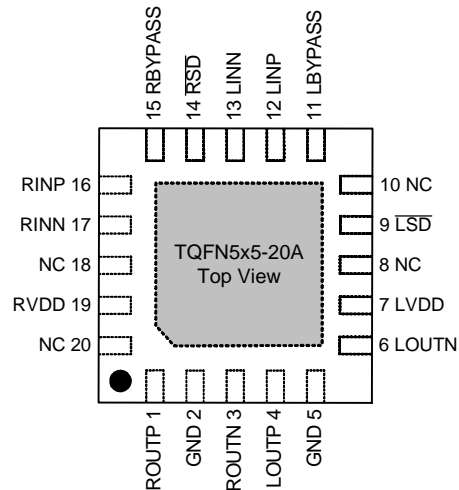

Pin Configuration



 = Thermal Pad (connected the Thermal Pad to GND plane for better heat dissipation)

ANPEC reserves the right to make changes to improve reliability or manufacturability without notice, and advise customers to obtain the latest version of relevant information to verify before placing orders.

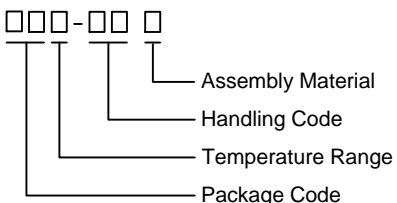
Ordering and Marking Information

APA2037		Package Code QB : TQFN5x5-20A Operating Ambient Temperature Range I : -40 to 85°C Handling Code TR : Tape & Reel Assembly Material L : Lead Free Device G : Halogen and Lead Free Device
APA2037 QB :		XXXXX - Date Code

Note : ANPEC lead-free products contain molding compounds/die attach materials and 100% matte tin plate termination finish; which are fully compliant with RoHS. ANPEC lead-free products meet or exceed the lead-free requirements of IPC/JEDEC J-STD-020C for MSL classification at lead-free peak reflow temperature. ANPEC defines “Green” to mean lead-free (RoHS compliant) and halogen free (Br or Cl does not exceed 900ppm by weight in homogeneous material and total of Br and Cl does not exceed 1500ppm by weight).

Absolute Maximum Ratings (Note 1)

(Over operating free-air temperature range unless otherwise noted.)

Symbol	Parameter	Rating	Unit
V _{DD}	Supply Voltage (LVDD, RVDD to GND)	-0.3 to 6	V
V _{IN}	Input Voltage (LINN, LINP, RINN, RINP, \overline{LSD} , \overline{RSD} to GND)	-0.3 to V _{DD} +0.3	V
T _J	Maximum Junction Temperature	150	°C
T _{STG}	Storage Temperature Range	-65 to +150	°C
T _{SDR}	Maximum Lead Soldering Temperature, 10 Seconds	260	°C
P _D	Power Dissipation	Internally Limited	W

Note 1: Absolute Maximum Ratings are those values beyond which the life of a device may be impaired. Exposure to absolute maximum rating conditions for extended periods may affect device reliability.

Thermal Characteristics

Symbol	Parameter	Typical Value	Unit
θ _{JA}	Thermal Resistance -Junction to Ambient TQFN5x5-20A <small>(Note 2)</small>	40	°C/W
θ _{JC}	Thermal Resistance -Junction to Case TQFN5x5-20A <small>(Note 3)</small>	8	°C/W

Note 2: Please refer to “Layout Recommendation”, the Thermal Pad on the bottom of the IC should soldered directly to the PCB’s ThermalPad area that with several thermal vias connect to the ground plan, and the PCB is a 2-layer, 5-inch square area with 2oz copper thickness.

Note 3: The case temperature is measured at the center of the Thermal Pad on the underside of the TQFN5X5-32A package.

Recommended Operating Conditions

Symbol	Parameter	Range	Unit
V _{DD}	Supply Voltage	2.4 ~ 5.5	V
V _{IH}	High Level Threshold Voltage	$\overline{\text{LSD}}, \overline{\text{RSD}}$	V
V _{IL}	Low Level Threshold Voltage	$\overline{\text{LSD}}, \overline{\text{RSD}}$	V
V _{IC}	Common Mode Input Voltage	0.5 ~ V _{DD} -0.5	
	Operating Ambient Temperature Range	-40 ~ 85	°C
	Operating Junction Temperature Range	-40 ~ 125	°C
	Speaker Resistance	3 ~	Ω

Electrical Characteristics

V_{DD}=5V, Gnd=0V, T_A= 25°C (unless otherwise noted)

Symbol	Parameter	Test Conditions	APA2037			Unit	
			Min.	Typ.	Max.		
I _{DD}	Supply Current		-	6	12	mA	
I _{SD}	Shutdown Current	$\overline{\text{LSD}} = \overline{\text{RSD}} = 0\text{V}$	-	1	5	μA	
I _I	Input Current	$\overline{\text{LSD}}, \overline{\text{RSD}}$	-	0.1	-	μA	
Gain		R _L =4Ω	$\frac{36\text{k}\Omega}{R_i}$	$\frac{40\text{k}\Omega}{R_i}$	$\frac{44\text{k}\Omega}{R_i}$	V/V	
T _{START-UP}	Start-Up Time from End of Shutdown	C _{b1} =C _{b2} = 0.22μF	-	65	-	ms	
R _{SD}	Resistance from Shutdown to GND		90	100	110	kΩ	
V_{DD}=5V, T_A=25 C							
P _O	Output Power	THD+N = 1%	R _L = 3Ω	-	2.4	-	W
			R _L = 4Ω	-	2.1	-	
			R _L = 8Ω	1	1.3	-	
		THD+N = 10% f _{in} = 1kHz	R _L = 3Ω	-	3	-	
			R _L = 4Ω	-	2.6	-	
			R _L = 8Ω	-	1.6	-	
THD+N	Total Harmonic Distortion Pulse Noise	f _{in} = 1kHz	R _L = 4Ω P _O = 1.5W	-	0.05	-	%
			R _L = 8Ω P _O = 0.9W	-	0.035	-	
Crosstalk	Channel separation	P _O =130mW, R _L =8Ω, f _{in} = 1kHz	-	105	-	dB	
PSRR	Power Supply Rejection Ratio	C _{b1} = C _{b2} = 0.22μF, R _L = 8Ω, V _{RR} =0.2V _{PP} , f _{in} = 217Hz	-	80	-		
CMRR	Common-Mode Rejection Ratio	C _{b1} = C _{b2} = 0.22μF, R _L = 8Ω, V _{IC} =0.2V _{PP} , f _{in} = 217Hz	-	60	-		
S/N	Signal to Noise Ratio	With A-weighting Filter P _O = 1.3W, R _L = 8Ω	-	105	-	dB	
V _{OS}	Output Offset Voltage	R _L = 8Ω	-	5	20	mV	
V _n	Noise Output Voltage	C _{b1} = C _{b2} = 0.22μF, With A-weighting Filter	-	15	-	μV (rms)	

Electrical Characteristics (Cont.)

$V_{DD}=5V$, $GND=0V$, $T_A = 25^\circ C$ (unless otherwise noted)

Symbol	Parameter	Test Conditions	APA2037			Unit	
			Min.	Typ.	Max.		
$V_{DD}=3.6V$, $T_A=25^\circ C$							
P_O	Output Power	THD+N = 1%	$R_L = 3\Omega$	-	1.2	-	W
			$R_L = 4\Omega$	-	1	-	
			$R_L = 8\Omega$	-	0.65	-	
		THD+N = 10% $f_{in} = 1kHz$	$R_L = 3\Omega$	-	1.5	-	
			$R_L = 4\Omega$	-	1.3	-	
			$R_L = 8\Omega$	-	0.8	-	
THD+N	Total Harmonic Distortion Pulse Noise	$f_{in} = 1kHz$	$R_L = 4\Omega$ $P_O = 0.7W$	-	0.07	-	%
			$R_L = 8\Omega$ $P_O = 0.45W$	-	0.05	-	
Crosstalk	Channel separation	$P_O=65mW$, $R_L=8\Omega$, $f_{in}=1kHz$		-	105	-	dB
PSRR	Power Supply Rejection Ratio	$C_{b1} = C_{b2} = 0.22\mu F$, $R_L = 8\Omega$, $V_{RR}=0.2V_{PP}$, $f_{in} = 217Hz$		-	78	-	
CMRR	Common-Mode Rejection Ratio	$C_{b1} = C_{b2} = 0.22\mu F$, $R_L = 8\Omega$, $V_{IC}=0.2V_{PP}$, $f_{in} = 217Hz$		-	60	-	
S/N	Signal to Noise Ratio	With A-weighting Filter $P_O = 0.65W$, $R_L = 8\Omega$		-	103	-	
V_{OS}	Output Offset Voltage	$R_L = 8\Omega$		-	5	20	mV
V_n	Noise Output Voltage	$C_{b1} = C_{b2} = 0.22\mu F$, With A-weighting Filter		-	15	-	μV (rms)
$V_{DD}=2.4V$, $T_A=25^\circ C$							
P_O	Output Power	THD+N = 1%	$R_L = 3\Omega$	-	0.5	-	W
			$R_L = 4\Omega$	-	0.45	-	
			$R_L = 8\Omega$	-	0.3	-	
		THD+N = 10% $f_{in} = 1kHz$	$R_L = 3\Omega$	-	0.7	-	
			$R_L = 4\Omega$	-	0.6	-	
			$R_L = 8\Omega$	-	0.35	-	
THD+N	Total Harmonic Distortion Pulse Noise	$f_{in} = 1kHz$	$P_O = 0.3W$, $R_L = 4\Omega$	-	0.1	-	%
			$P_O = 0.2W$, $R_L = 8\Omega$	-	0.08	-	
Crosstalk	Channel Separation	$P_O=30mW$, $R_L=8\Omega$, $f_{in}=1kHz$		-	105	-	dB
PSRR	Power Supply Rejection Ratio	$C_{b1} = C_{b2} = 0.22\mu F$, $R_L = 8\Omega$, $V_{RR}=0.2V_{PP}$, $f_{in} = 217Hz$		-	75	-	
CMRR	Common-Mode Rejection Ratio	$C_{b1} = C_{b2} = 0.22\mu F$, $R_L = 8\Omega$, $V_{IC}=0.2V_{PP}$, $f_{in} = 217Hz$		-	60	-	
S/N	Signal to Noise Ratio	With A-weighting Filter $P_O = 0.3W$, $R_L = 8\Omega$		-	100	-	
V_{OS}	Output Offset Voltage	$R_L = 8\Omega$		-	5	20	mV
V_n	Noise Output Voltage	$C_{b1} = C_{b2} = 0.22\mu F$, With A-weighting Filter		-	15	-	μV (rms)

Pin Description

PIN		I/O/P	FUNCTION
NO.	NAME		
1	ROUTP	O	The right channel positive output terminal of speaker amplifier.
2,5	GND	P	Ground connection for circuitry.
3	ROUTN	O	The right channel negative output terminal of speaker amplifier
4	LOUTP	O	The left channel positive output terminal of speaker amplifier.
6	LOUTN	O	The left channel negative output terminal of speaker amplifier.
7	LVDD	P	Left channel supply voltage input pin.
8,10,18,20	NC	-	No connection.
9	$\overline{\text{LSD}}$	I	Left channel shutdown mode control signal input pin, place left channel speaker amplifier in shutdown mode when held low.
11	LBYPASS	P	Left channel bypass voltage input pin.
12	LINP	I	The non-inverting input of left channel amplifier. LINP is connected to ground (Gnd node) via a capacitor for single-end (SE) input signal.
13	LINN	I	The inverting input of left channel amplifier. LINN is used as audio input terminal, typically.
14	$\overline{\text{RSD}}$	I	Right channel shutdown mode control signal input pin, place left channel speaker amplifier in shutdown mode when held low.
15	RBYPASS	P	Right channel bypass voltage input pin.
16	RINP	I	The non-inverting input of right channel amplifier. RINP is connected to ground (Gnd node) via a capacitor for single-end (SE) input signal.
17	RINN	I	The inverting input of right channel amplifier. RINN is used as audio input terminal, typically.
19	RVDD	P	Right channel supply voltage input pin

Typical Operating Characteristics

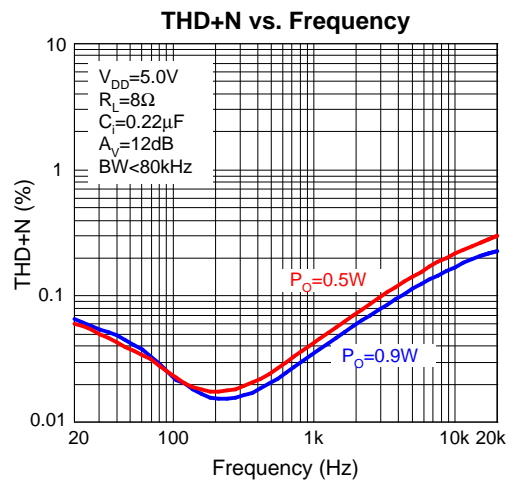
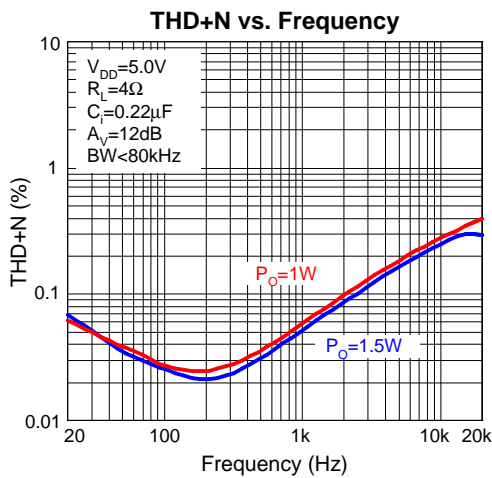
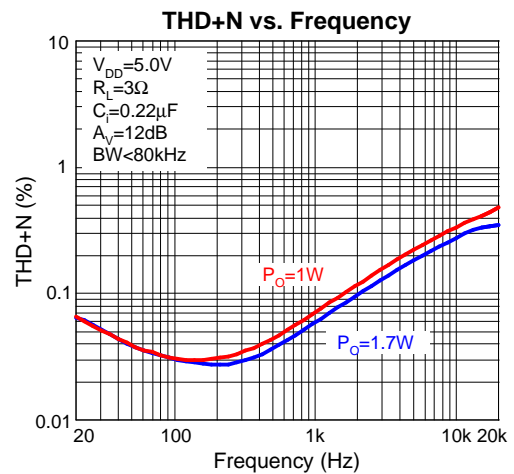
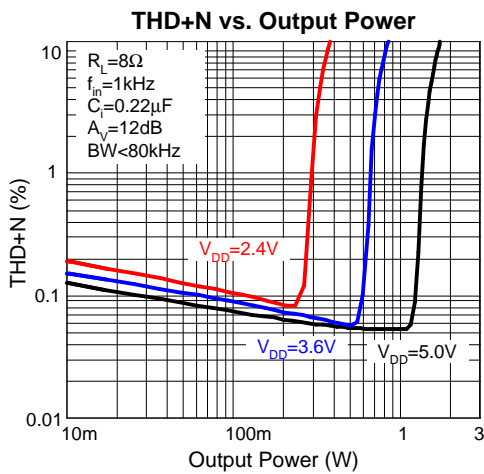
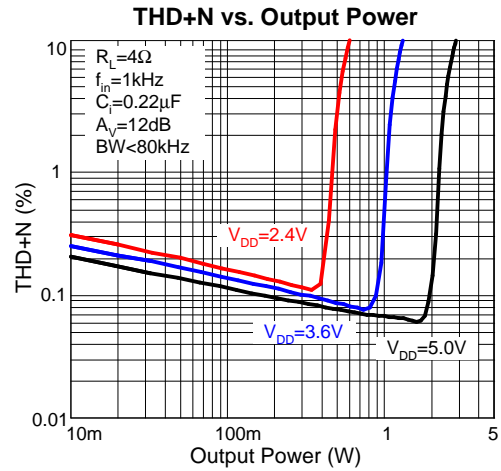
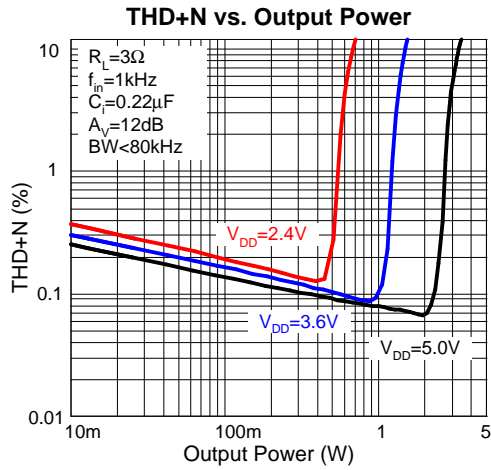

Typical Operating Characteristics (Cont.)

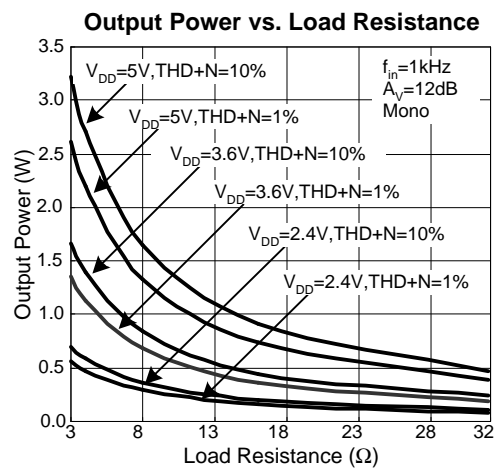
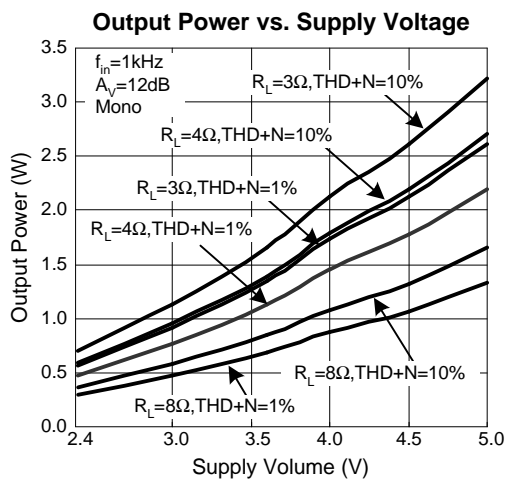
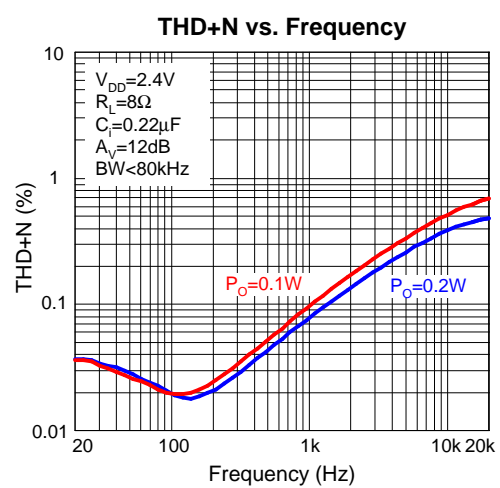
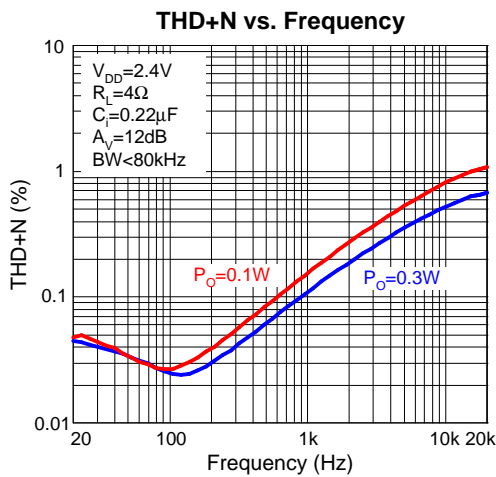
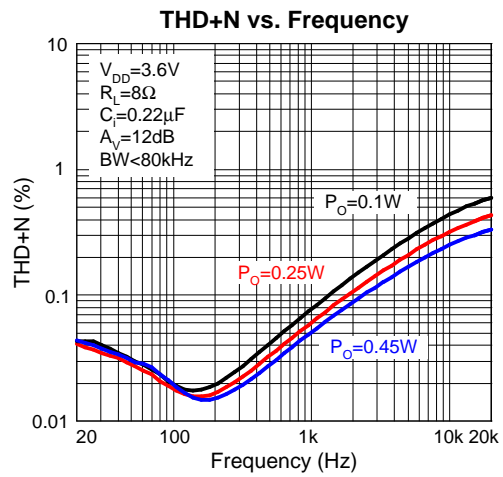
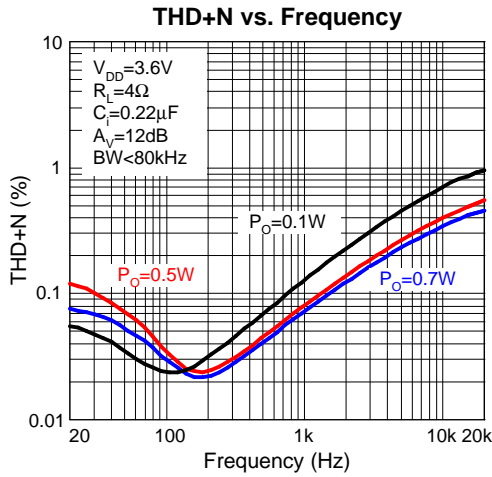

Typical Operating Characteristics (Cont.)

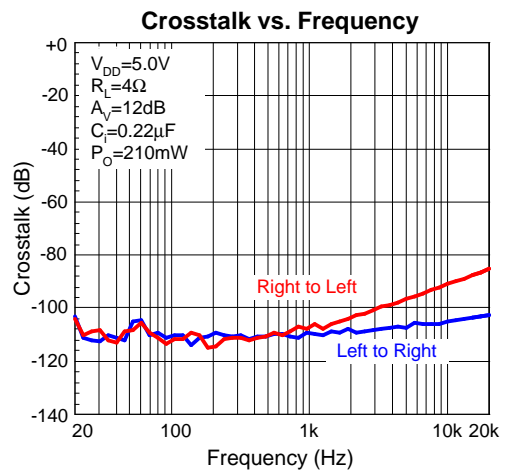
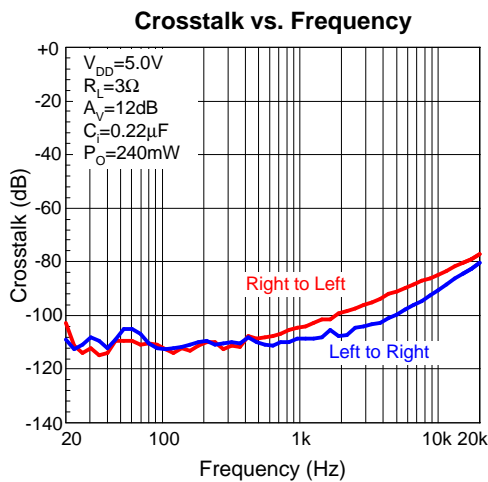
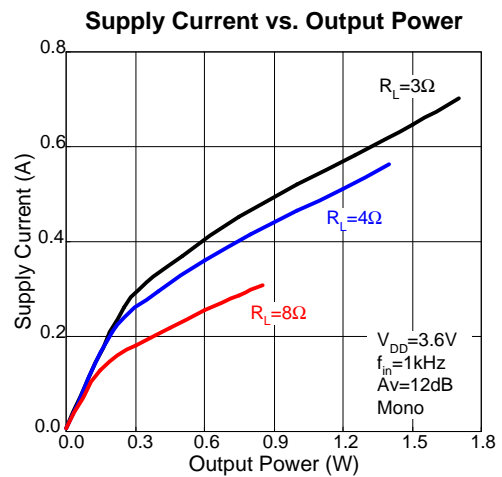
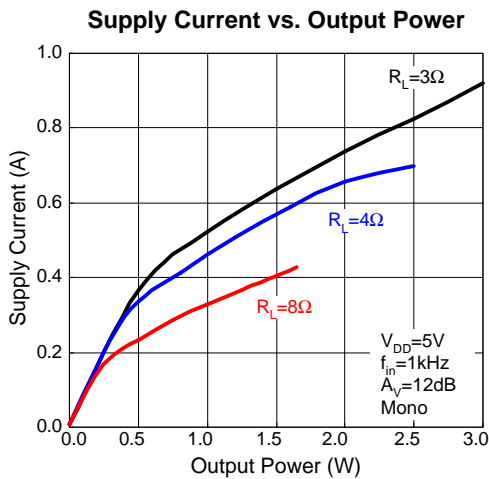
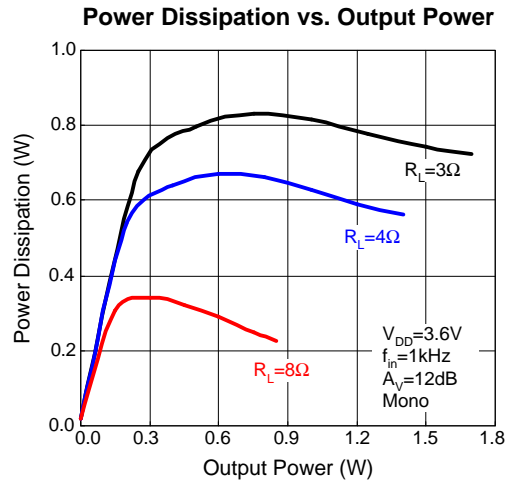
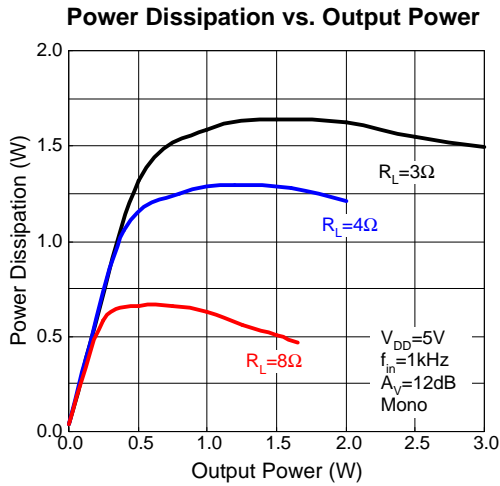

Typical Operating Characteristics (Cont.)

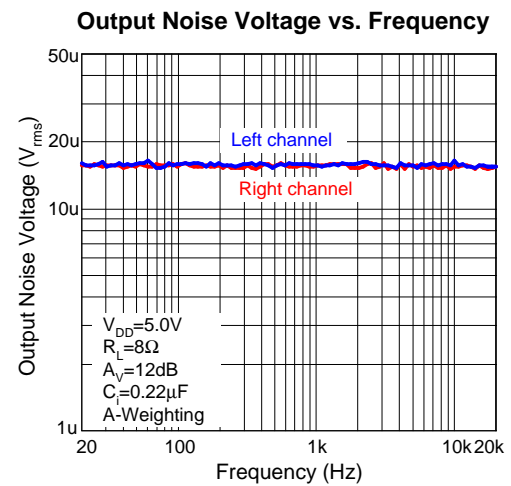
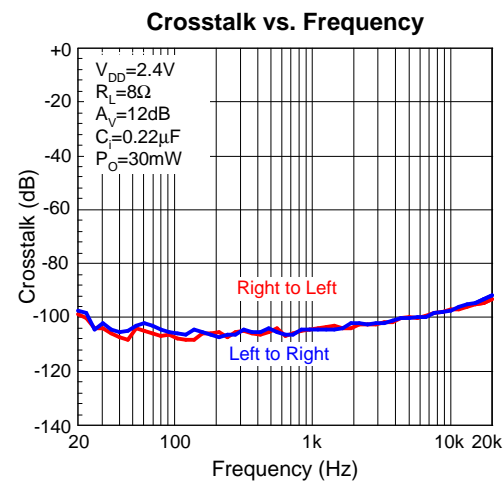
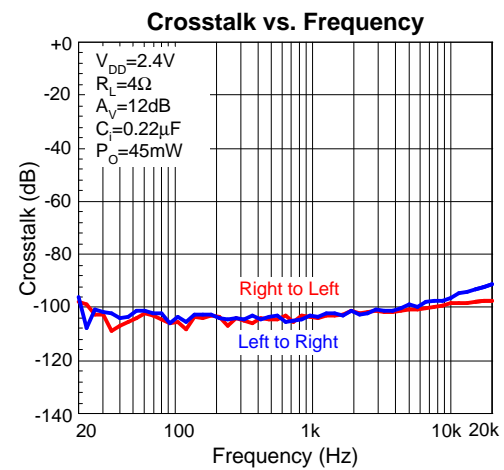
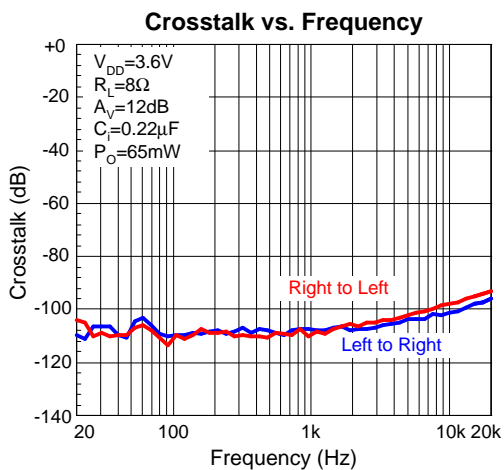
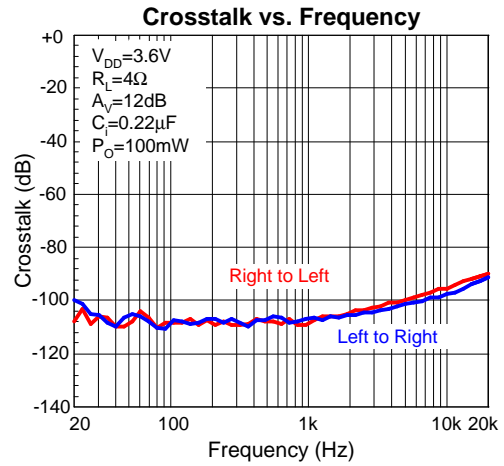
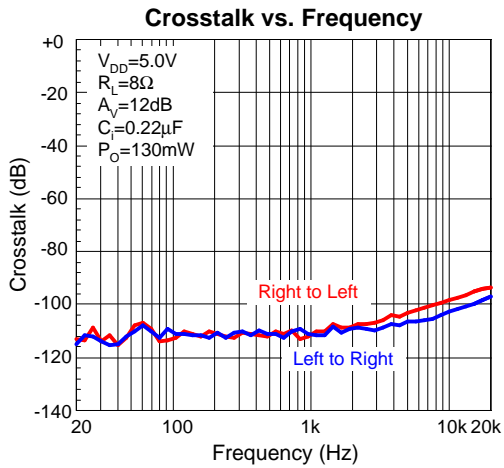

Typical Operating Characteristics (Cont.)

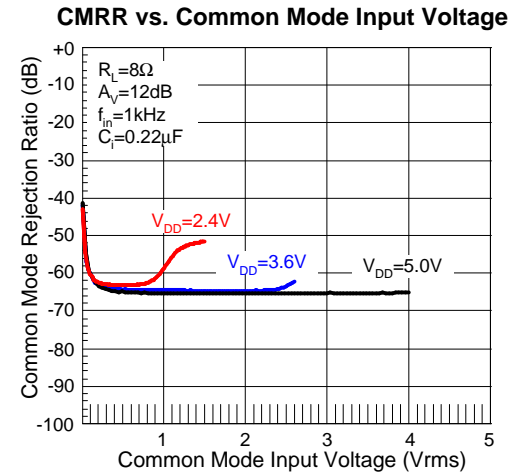
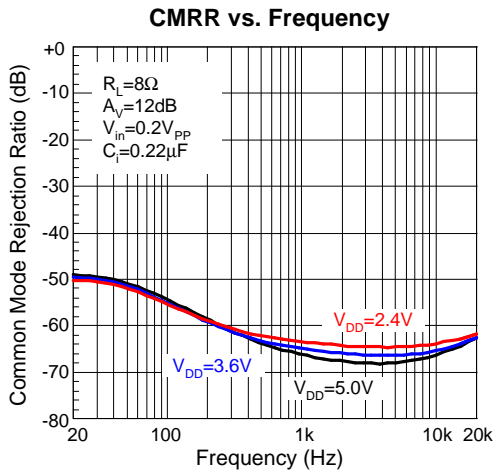
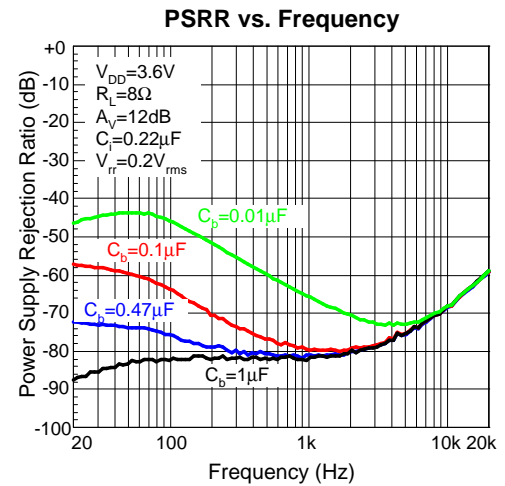
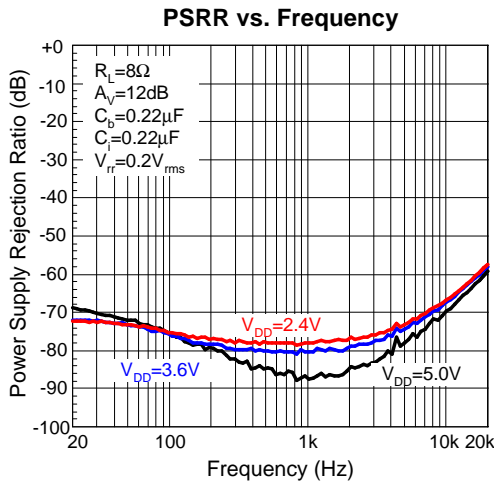
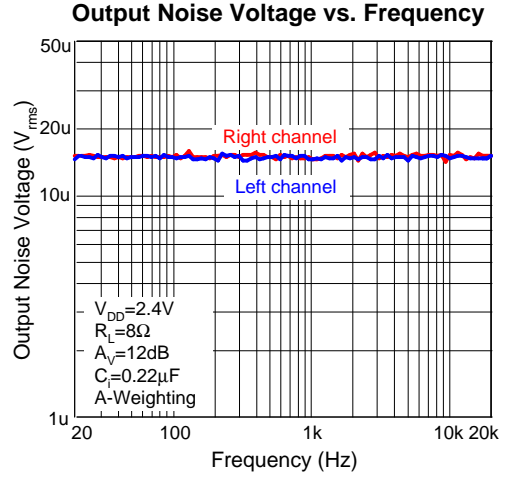
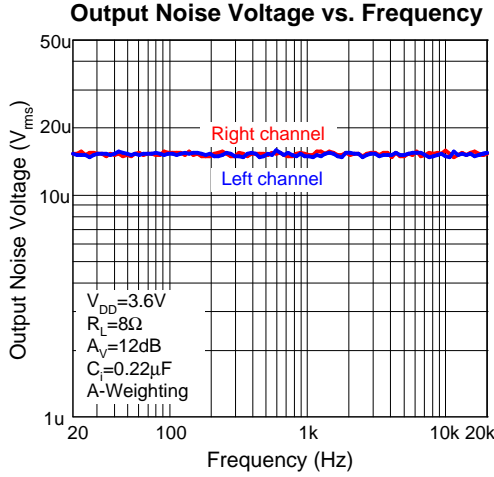

Typical Operating Characteristics (Cont.)

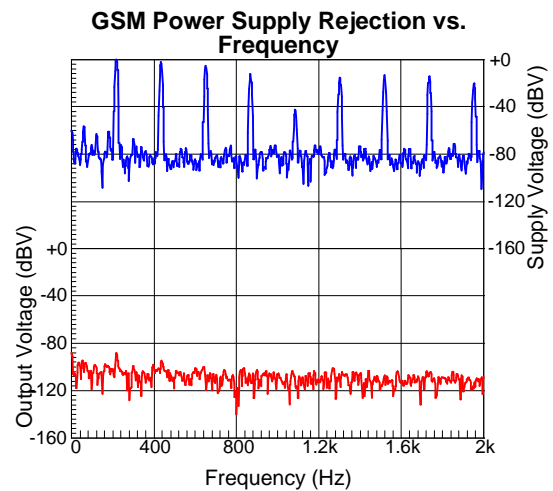
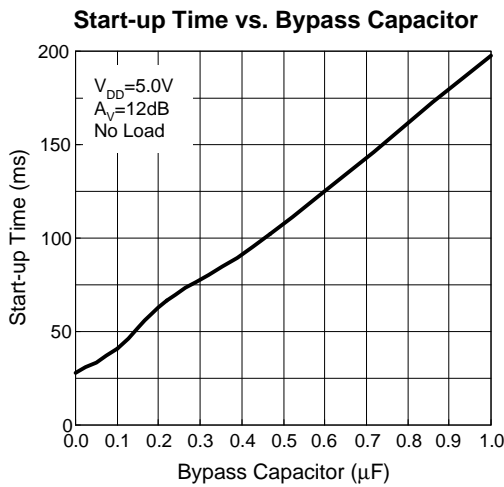
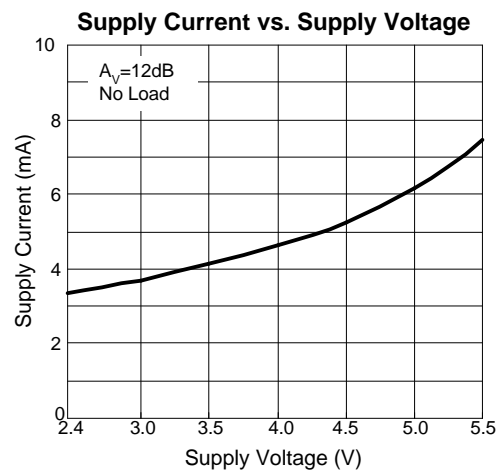
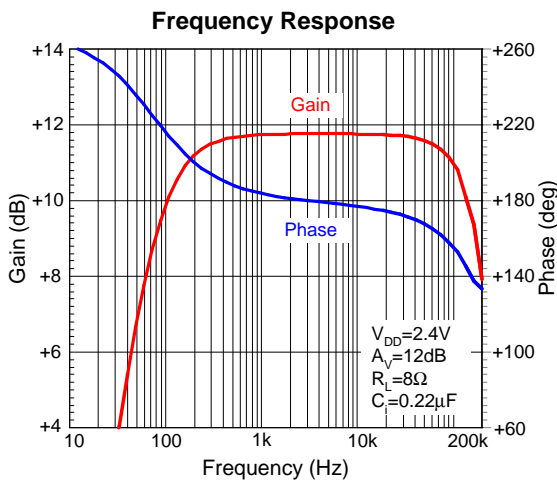
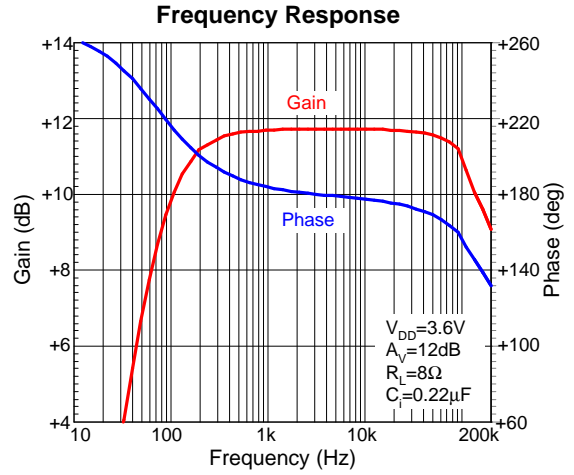
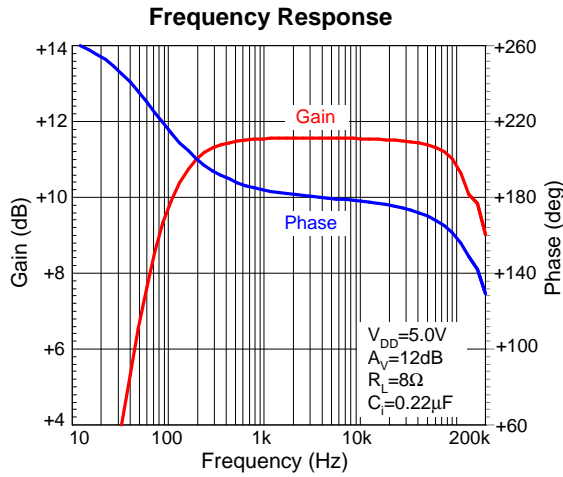

Operating Waveforms

GSM Power Supply Rejection vs. Time

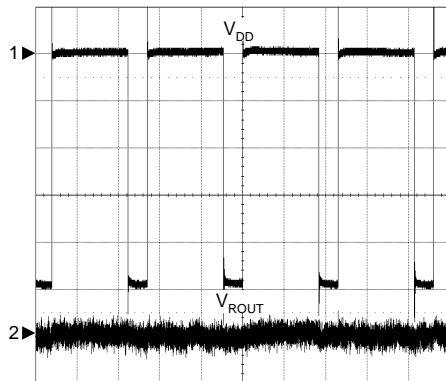

CH1: V_{DD} , 100mV/Div, DC
 Voltage Offset = 5.0V
 CH2: V_{ROUT} , 20mV/Div, DC
 TIME: 2ms/Div

Power On

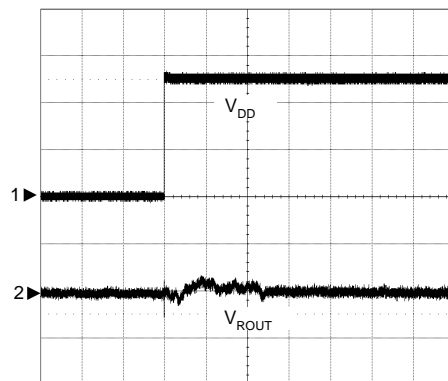

CH1: V_{DD} , 2V/Div, DC
 CH2: V_{ROUT} , 50mV/Div, DC
 TIME: 20ms/Div

Power Off

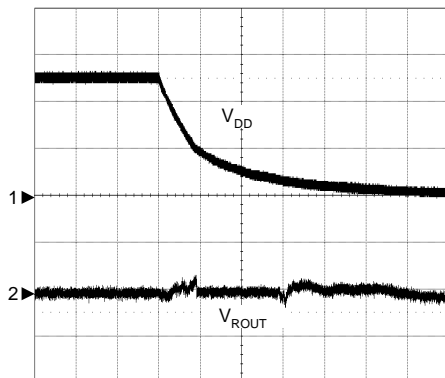

CH1: V_{DD} , 2V/Div, DC
 CH2: V_{ROUT} , 50mV/Div, DC
 TIME: 50ms/Div

Shutdown Release

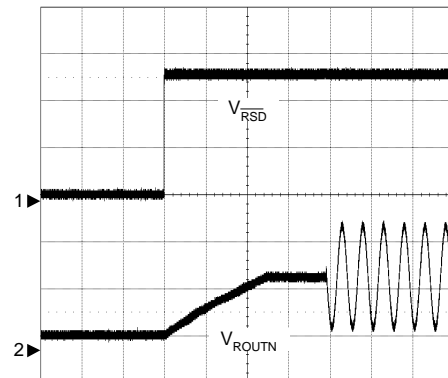

CH1: V_{RSD} , 2V/Div, DC
 CH2: V_{ROUTN} , 2V/Div, DC
 TIME: 20ms/Div

Operating Waveforms (Cont.)

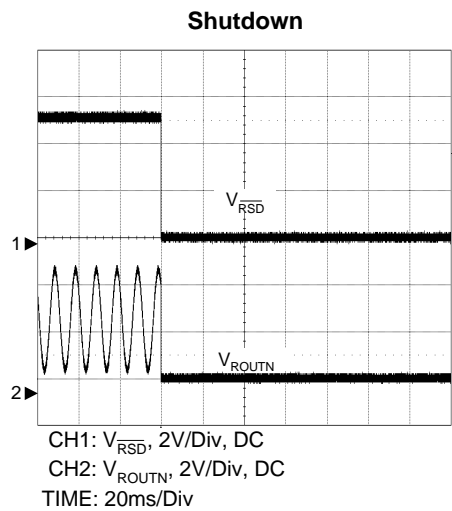

Block Diagram

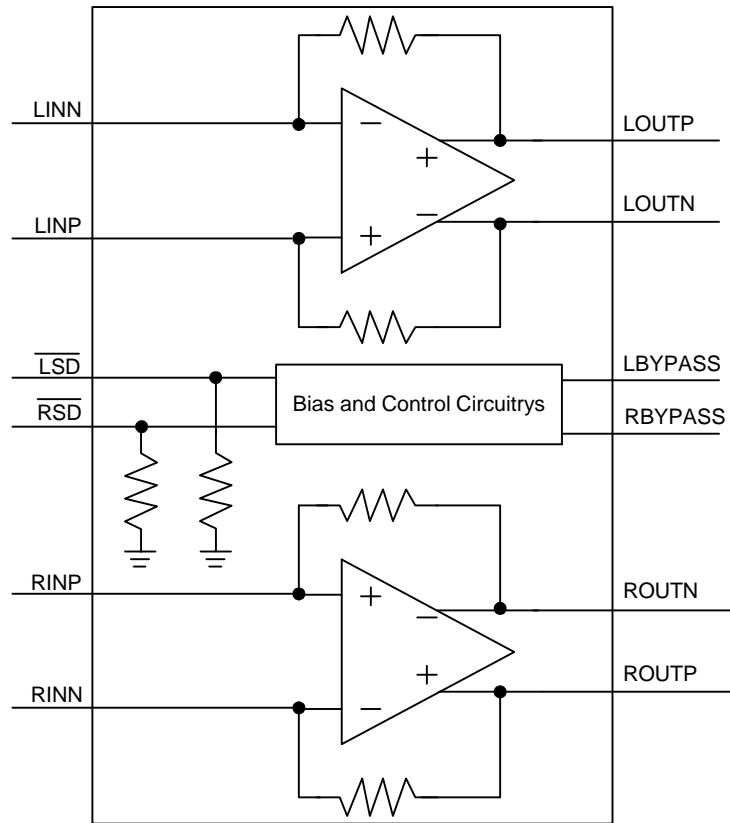

Typical Application Circuits

Single-ended input mode

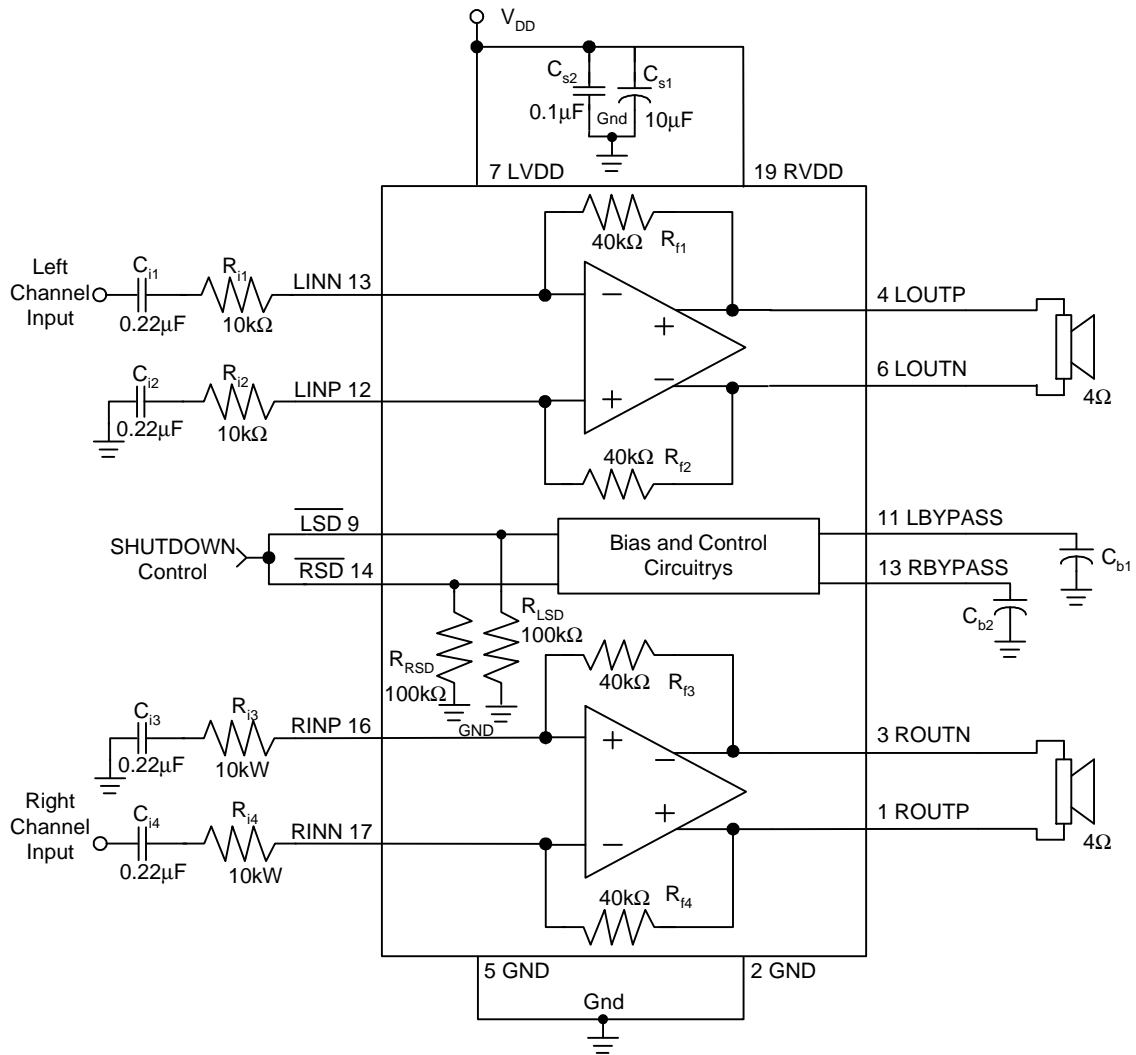

Typical Application Circuits (Cont.)

Differential input mode

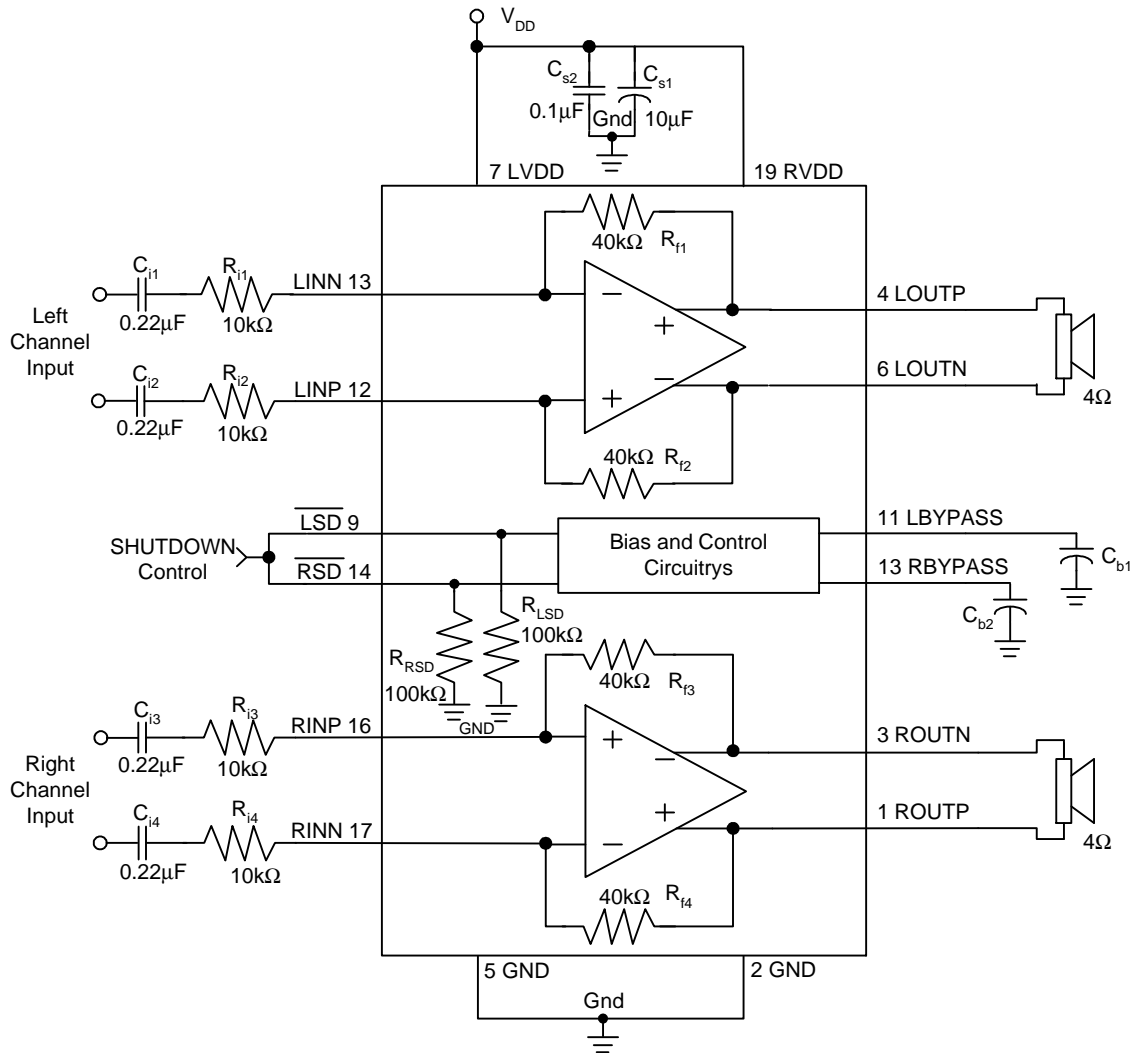

Function Description

Fully Differential Amplifier

The power amplifiers are fully differential amplifiers with differential inputs and outputs. The fully differential amplifier has some advantages versus traditional amplifiers. First, don't need the input coupling capacitors because the common-mode feedback compensates the input bias. The inputs can be biased from $0.5V \sim V_{DD} - 0.5V$, and the outputs are still biased at mid-supply of the power amplifier. If the inputs are biased at out of the input range, the coupling capacitors are required. Second, the fully differential amplifier has outstanding immunity against supply voltage ripple (217Hz) caused by the GSM RF transmitters' signal which is better than the typical audio amplifier.

Mono Operation

The APA2037 has independent shutdown to control each channel's power amplifier, this allows user switching audio amplifier to stereo or mono operation and giving flexible control at design.

Thermal Protection

The over-temperature circuit limits the junction temperature of the APA2037. When the junction temperature exceeds $T_j = +150^\circ\text{C}$, a thermal sensor turns off the amplifiers, allowing the device to cool. The thermal sensor allows the amplifiers to start-up after the junction temperature cools down to about 125°C . The thermal protection is designed with a 25°C hysteresis to lower the average T_j during continuous thermal overload conditions, increasing lifetime of the IC.

Over-Current Protection

The APA2037 monitors the output buffers' current. When the over current occurs, the output buffers' current will be reduced and limited to a fold-back current level.

The power amplifier will go back to normal operation until the over-current situation has been removed. In addition, if the over-current period is long enough and the IC's junction temperature reaches the thermal protection threshold, the IC enters thermal protection mode.

Shutdown Function

The APA2037 has separated shutdown control for each channel. User can shutdown left channel amplifier by $\overline{\text{LSD}}$, or shutdown right channel amplifier by $\overline{\text{RSD}}$. If all the amplifiers are shutdown, APA2037 only consumes $1\mu\text{A}$ typical..

Application Information

Input Resistance (R_i)

The gain for the APA2037 is set by the external input resistors (R_i) and internal feedback resistors (R_f).

$$A_v = \frac{R_f}{R_i} \quad (1)$$

The internal feedback resistors are $40\text{k}\Omega$ typical. For the performance of a fully differential amplifier, it's better to select matching input resistors R_{i1} , R_{i2} , R_{i3} , and R_{i4} . Therefore, 1% tolerance resistors are recommended. If the input resistors are not matched, the CMRR and PSRR performance are worse than using matching devices.

Input Capacitor (C_i)

When the APA2037 is driven by a differential input source, the input capacitor may not be required.

In the single-ended input application, an input capacitor, C_i , is required to allow the amplifier to bias the input signal to the proper DC level for optimum operation. In this case, C_i and the input resistance R_i form a high-pass filter with the corner frequency determined in the following equation:

$$F_{C(\text{highpass})} = \frac{1}{2\pi R_i C_i} \quad (2)$$

The value of C_i must be considered carefully because it directly affects the low frequency performance of the circuit. Consider the example where R_i is $10\text{k}\Omega$ and the specification that calls for a flat bass response down to 100Hz . The equation is reconfigured below:

$$C_i = \frac{1}{2\pi R_i F_c} \quad (3)$$

Consider the input resistance variation, the C_i should be $0.16\mu\text{F}$. Therefore, one would likely choose a value in the range of $0.22\mu\text{F}$ to $0.47\mu\text{F}$. A further consideration for this capacitor is the leakage path from the input source through the input network ($R_i + R_f$, C_i) to the load.

This leakage current creates a DC offset voltage at the input of the amplifier. The offset reduces useful headroom, especially in high gain applications. For this reason a low-leakage tantalum or ceramic capacitor is the best choice. When polarized capacitors are used, the positive side of the capacitor should face the amplifier input in most applications because the DC level of the amplifiers' inputs are held at $V_{DD}/2$. Please note that it is important to confirm the capacitor polarity in the application.

Application Information (Cont.)

Effective Bypass Capacitor (C_{BYPASS})

The BYPASS pin sets the $V_{\text{DD}}/2$ for internal reference by voltage divider. Adding capacitors at this pin to filter the noise and regulator the mid-supply rail will increase the PSRR and noise performance.

The capacitors should be as close to the device as possible. The effect of a larger bypass capacitor will improve PSRR due to increased supply stability.

The bypass capacitance also affects to the start time. The large capacitors will increase the start time when device exist shutdown.

Optimizing Depop Circuitry

Circuitry has been included in the APA2037 to minimize the amount of popping noise at power-up and when coming out of shutdown mode. Popping occurs whenever a voltage step is applied to the speaker. In order to eliminate clicks and pops, all capacitors must be fully discharged before turn-on. Rapid on/off switching of the device or the shutdown function will cause the click and pop circuitry.

The value of C_i will also affect turn-on pops. The bypass voltage ramp up should be slower than input bias voltage.

Although the BYPASS pin current source cannot be modified, the size of C_{BYPASS} can be changed to alter the device turn-on time and the amount of clicks and pops. By increasing the value of C_{BYPASS} , turn-on pop can be reduced. However, the tradeoff for using a larger bypass capacitor is to increase the turn-on time for this device. There is a linear relationship between the size of C_{BYPASS} and the turn-on time.

A high gain amplifier intensifies the problem as the small delta in voltage is multiplied by the gain. Hence, it is advantageous to use low-gain configurations.

Power Supply Decoupling Capacitor (C_s)

The APA2037 is a high-performance CMOS audio amplifier that requires adequate power supply decoupling to ensure the output total harmonic distortion (THD+N) is as low as possible. Power supply decoupling also prevents the oscillations caused by long lead length between the amplifier and the speaker.

The optimum decoupling is achieved by using two different types of capacitors that target on different types of noises on the power supply leads. For higher frequency transients, spikes, or digital hash on the line, a good low equivalent-series-resistance (ESR) ceramic capacitor, typically 0.1 μ F, is placed as close as possible to the device VDD lead works best. For filtering lower frequency noise signals, a large aluminum electrolytic capacitor of 10 μ F or greater placed near the audio power amplifier is recommended.

Fully Differential Amplifier Efficiency

The traditional class AB power amplifier efficiency can be calculated starts out as being equal to the ratio of power from the power supply to the power delivered to the load. The following equations are the basis for calculating amplifier efficiency.

$$\text{Efficiency } (\eta) = \frac{P_O}{P_{\text{SUP}}} \tag{4}$$

where:

$$P_O = \frac{V_{\text{Orms}}^2}{R_L} = \frac{V_P^2}{2R_L}$$

$$V_{\text{Orms}} = \frac{V_P}{\sqrt{2}}$$

$$P_{\text{SUP}} = V_{\text{DD}} I_{\text{DD (AVG)}} = \frac{2V_{\text{DD}} V_{\text{PP}}}{\pi R_L} \tag{5}$$

$$I_{\text{DD (AVG)}} = \frac{2V_P}{\pi R_L}$$

So the Efficiency (η) is:

$$\text{Efficiency } (\eta) = \frac{\pi V_P}{4V_{\text{DD}}} = \frac{\pi \sqrt{2P_O R_L}}{4V_{\text{DD}}} \tag{6}$$

Table 1 calculates efficiencies for four different output power levels. Note that the efficiency of the amplifier is quite low for lower power levels and rises sharply as power to the load is increased resulting in nearly flat internal power dissipation over the normal operating range. Note that the internal dissipation at full output power is less than in the half power range. Calculating the efficiency for a specific system is the key to proper power supply design. For a stereo 1W audio system with 8 Ω loads and a 5V supply, the maximum draw on the power supply is almost 1.63W.

Application Information (Cont.)

Fully Differential Amplifier Efficiency (Cont.)

R _L (W)	P _o (W)	Efficiency (%)	I _{DD} (A)	P _D (W)	P _{SUP} (W)
8	0.25	30.1	0.17	0.58	0.83
	0.50	43.1	0.23	0.66	1.16
	1	61.5	0.33	0.63	1.63
	1.6	77.7	0.43	0.46	2.06
4	0.4	27.5	0.29	1.06	1.46
	1.2	48.1	0.51	1.30	2.50
	2	62.4	0.66	1.21	3.21
	2.6	74.1	0.70	0.91	3.51
3	0.5	27.5	0.37	1.32	1.82
	1	38.7	0.52	1.58	2.58
	2	55.1	0.74	1.63	3.63
	3	66.8	0.92	1.49	4.49

Table 1: Efficiency vs. Output Power in 5-V Differential Amplifier Systems

A final point to remember about linear amplifiers (either SE or Differential) is how to manipulate the terms in the efficiency equation to utmost advantage when possible. Note that in equation, V_{DD} is in the denominator. This indicates that as V_{DD} goes down, efficiency goes up. In other words, use the efficiency analysis to choose the correct supply voltage and speaker impedance for the application.

Layout Recommendation

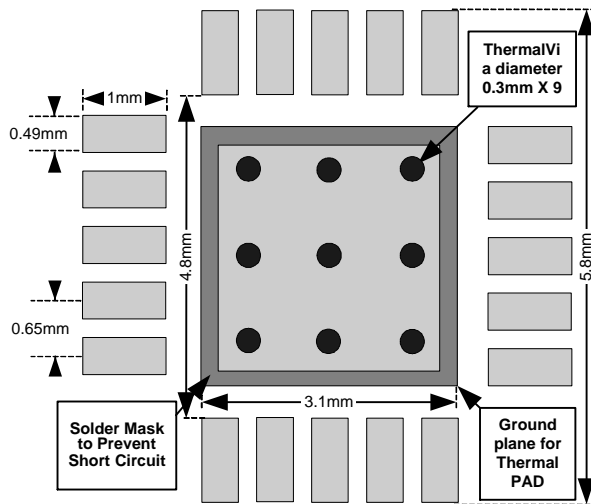
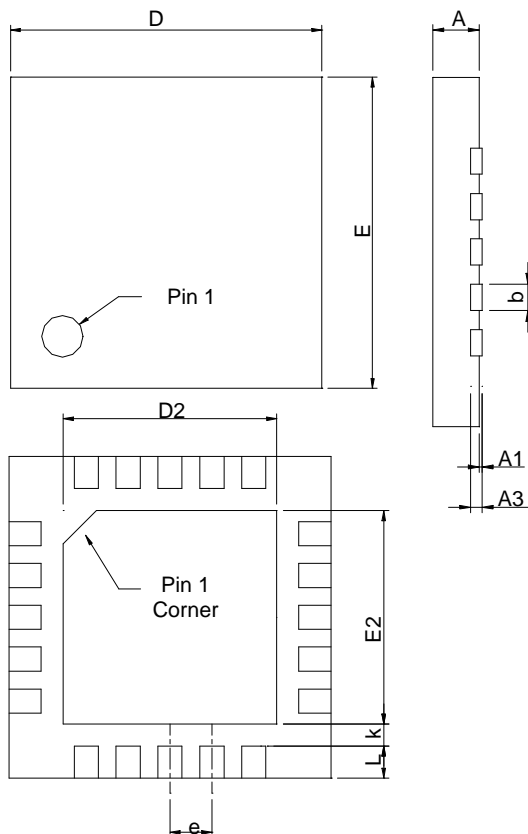

Figure 5. TQFN5x5-20A Land Pattern Recommendation

1. All components should be placed close to the APA2037. For example, the input capacitor (C_i) should be close to APA2037's input pins to avoid causing noise coupling to APA2037's high impedance inputs; the decoupling capacitor (C_s) should be placed by the APA2037's power pin to decouple the power rail noise.
2. The output traces should be short, wide (>50mil), and symmetric.
3. The input trace should be short and symmetric.
4. The power trace width should be greater than 50mil.
5. The TQFN5x5-20A Thermal PAD should be soldered on PCB, and the ground plane needs soldered mask (to avoid short circuit) except the Thermal PAD area.

Package Information

TQFN5x5-20A



SYMBOL	TQFN5x5-20A			
	MILLIMETERS		INCHES	
	MIN.	MAX.	MIN.	MAX.
A	0.70	0.80	0.028	0.031
A1	0.00	0.05	0.000	0.002
A3	0.20 REF		0.008 REF	
b	0.25	0.35	0.010	0.014
D	4.90	5.10	0.193	0.201
D2	3.00	3.40	0.118	0.134
E	4.90	5.10	0.193	0.201
E2	3.00	3.40	0.118	0.134
e	0.65 BSC		0.026 BSC	
L	0.45	0.65	0.018	0.026
K	0.20		0.008	

Carrier Tape & Reel Dimensions

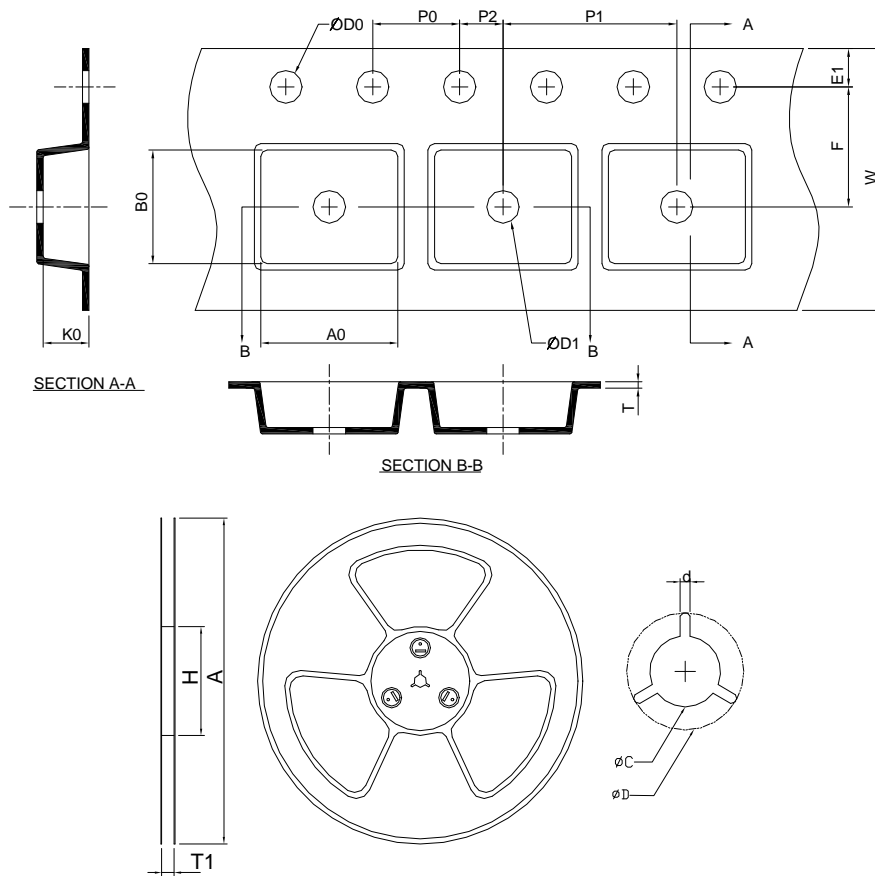

Application	A	H	T1	C	d	D	W	E1	F
TQFN5x5-20A	330.0 ±0.00	50 MIN.	12.4+2.00 -0.00	13.0+0.50 -0.20	1.5 MIN.	20.2 MIN.	12.0 ±0.30	1.75 ±0.10	5.5 ±0.10
	P0	P1	P2	D0	D1	T	A0	B0	K0
	4.0 ±0.10	8.0 ±0.10	2.0 ±0.05	1.5+0.10 -0.00	1.5 MIN.	0.6+0.00 -0.40	5.30 ±0.20	5.30 ±0.20	1.30 ±0.20

(mm)

Devices Per Unit

Package Type	Unit	Quantity
TQFN5x5-20A	Tape & Reel	2500

Taping Direction Information

TQFN5x5-20A

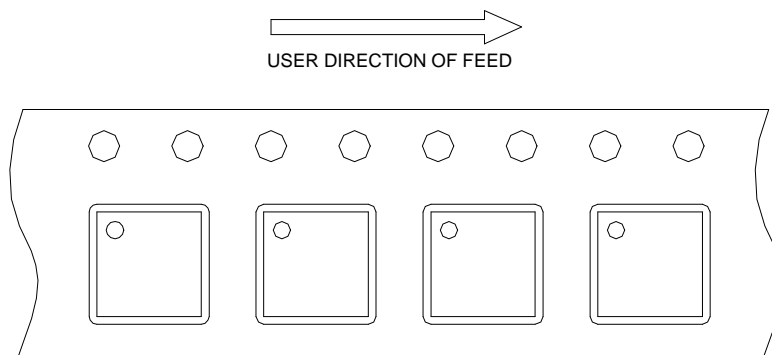

Reflow Condition (IR/Convection or VPR Reflow)

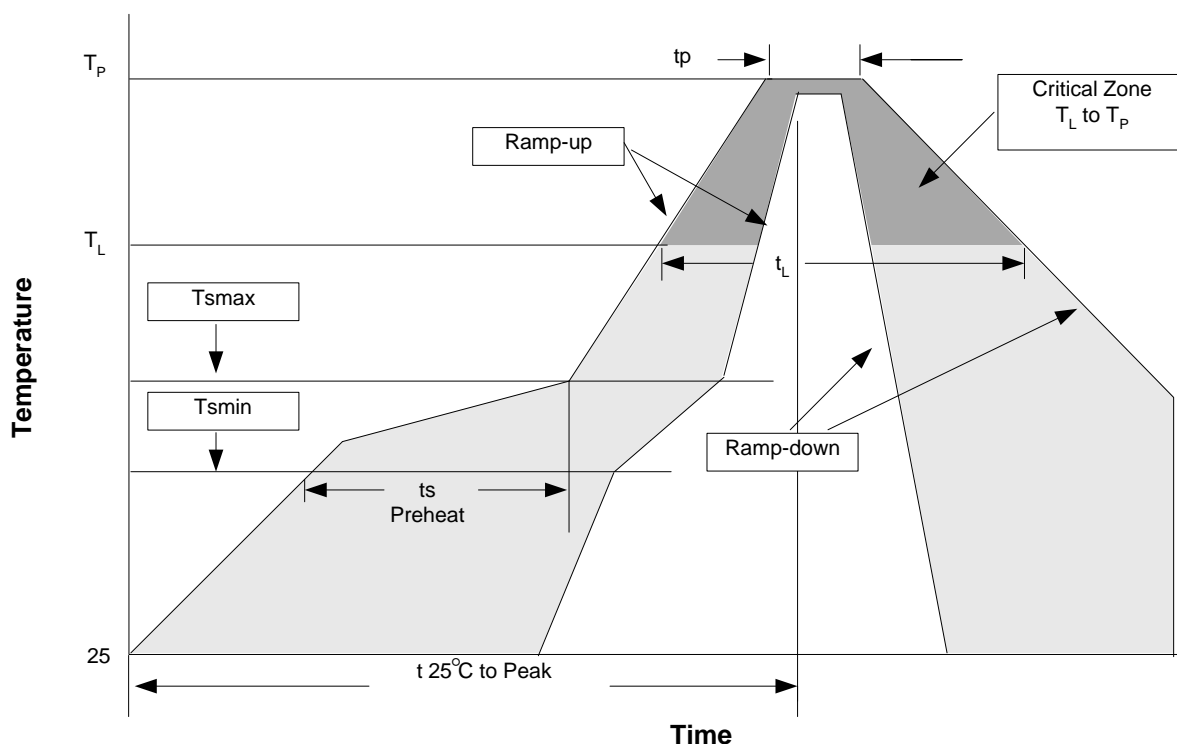

Reliability Test Program

Test item	Method	Description
SOLDERABILITY	MIL-STD-883D-2003	245°C, 5 sec
HOLT	MIL-STD-883D-1005.7	1000 Hrs Bias @ 125°C
PCT	JESD-22-B,A102	168 Hrs, 100%RH, 121°C
TST	MIL-STD-883D-1011.9	-65°C~150°C, 200 Cycles
ESD	MIL-STD-883D-3015.7	VHBM > 2KV, VMM > 200V
Latch-Up	JESD 78	10ms, 1 _{tr} > 100mA

Classification Reflow Profiles

Profile Feature	Sn-Pb Eutectic Assembly	Pb-Free Assembly
Average ramp-up rate (T_L to T_P)	3°C/second max.	3°C/second max.
Preheat - Temperature Min (T_{smin}) - Temperature Max (T_{smax}) - Time (min to max) (ts)	100°C 150°C 60-120 seconds	150°C 200°C 60-180 seconds
Time maintained above: - Temperature (T_L) - Time (t_L)	183°C 60-150 seconds	217°C 60-150 seconds
Peak/Classification Temperature (T_P)	See table 1	See table 2
Time within 5°C of actual Peak Temperature (t_P)	10-30 seconds	20-40 seconds
Ramp-down Rate	6°C/second max.	6°C/second max.
Time 25°C to Peak Temperature	6 minutes max.	8 minutes max.

Note: All temperatures refer to topside of the package. Measured on the body surface.

Table 1. SnPb Eutectic Process – Package Peak Reflow Temperatures

Package Thickness	Volume mm ³ <350	Volume mm ³ ≥350
<2.5 mm	240 +0/-5°C	225 +0/-5°C
≥2.5 mm	225 +0/-5°C	225 +0/-5°C

Table 2. Pb-free Process – Package Classification Reflow Temperatures

Package Thickness	Volume mm ³ <350	Volume mm ³ 350-2000	Volume mm ³ >2000
<1.6 mm	260 +0°C*	260 +0°C*	260 +0°C*
1.6 mm – 2.5 mm	260 +0°C*	250 +0°C*	245 +0°C*
≥2.5 mm	250 +0°C*	245 +0°C*	245 +0°C*

* Tolerance: The device manufacturer/supplier **shall** assure process compatibility up to and including the stated classification temperature (this means Peak reflow temperature +0°C. For example 260°C+0°C) at the rated MSL level.

Customer Service

Anpec Electronics Corp.

Head Office :

No.6, Dusing 1st Road, SBIP,
Hsin-Chu, Taiwan, R.O.C.
Tel : 886-3-5642000
Fax : 886-3-5642050

Taipei Branch :

2F, No. 11, Lane 218, Sec 2 Jhongsing Rd.,
Sindian City, Taipei County 23146, Taiwan
Tel : 886-2-2910-3838
Fax : 886-2-2917-3838