

# AT90-1283

Digital Attenuator  
15.5 dB, 5-Bit, TTL Driver, DC-3.5 GHz

Rev. V11

## Features

- Attenuation: 0.5 dB Steps to 15.5 dB
- Single Positive Supply
- Contains Internal DC to DC Converter
- Low DC Power Consumption
- Small Footprint, JEDEC Package
- Integral TTL Driver
- 50 ohm Impedance
- CSP-1 Package

## Description

M/A-COM's AT90-1283 is a GaAs FET 5-bit digital attenuator with integral TTL driver. Step size is 0.5 dB providing a 15.5 dB total attenuation range. This device is in an PQFN plastic surface mount package. The AT90-1283 is ideally suited for use where accuracy, fast speed, very low power consumption and low costs are required. For dual supply designs without switching noise, use AT90-0283.

## Schematic with Off-Chip Components

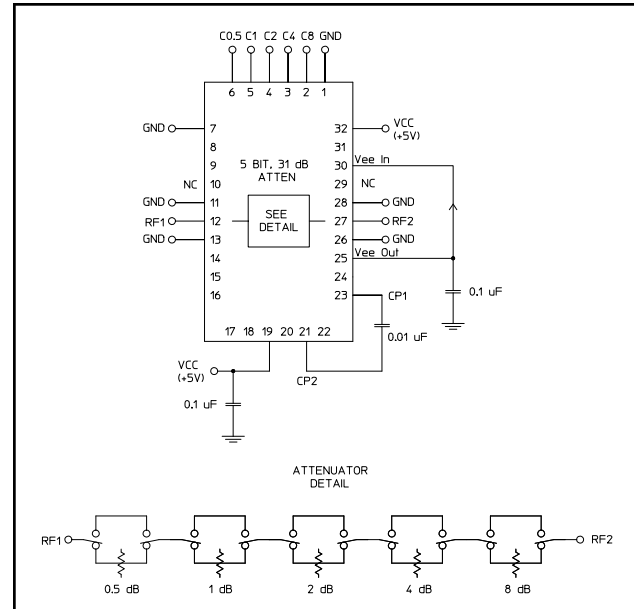

## Pin Configuration<sup>3</sup>

Pin No.	Function	Pin No.	Function
1	GND	17	NC
2	C8	18	NC
3	C4	19	Vcc
4	C2	20	NC
5	C1	21	Cp
6	C0.5	22	NC
7	GND	23	Cp
8	NC	24	NC
9	NC	25	V <sub>EE</sub> <sup>2</sup>
10	NC <sup>1</sup>	26	GND
11	GND	27	RF2
12	RF1	28	GND
13	GND	29	NC <sup>1</sup>
14	NC	30	V <sub>EE</sub> <sup>2</sup>
15	NC	31	NC
16	NC	32	Vcc

1. Pins 10 and 29 must be isolated.
2. V<sub>EE</sub> is produced internally and requires a .1  $\mu$ F cap to GND. Generated noise is typical of switching DC-DC Converters.
3. The exposed pad centered on the package bottom must be connected to RF and DC ground. (For PQFN Packages)

## Ordering Information

Part Number	Package
AT90-1283	Bulk Packaging
AT90-1283TR	1000 piece reel
AT90-1283-TB	Sample Test Board

Note: Reference Application Note M513 for reel size information.

**ADVANCED:** Data Sheets contain information regarding a product M/A-COM Technology Solutions is considering for development. Performance is based on target specifications, simulated results, and/or prototype measurements. Commitment to develop is not guaranteed.  
**PRELIMINARY:** Data Sheets contain information regarding a product M/A-COM Technology Solutions has under development. Performance is based on engineering tests. Specifications are typical. Mechanical outline has been fixed. Engineering samples and/or test data may be available. Commitment to produce in volume is not guaranteed.

• **North America** Tel: 800.366.2266 • **Europe** Tel: +353.21.244.6400  
• **India** Tel: +91.80.4155721 • **China** Tel: +86.21.2407.1588  
Visit [www.macomtech.com](http://www.macomtech.com) for additional data sheets and product information.

M/A-COM Technology Solutions Inc. and its affiliates reserve the right to make changes to the product(s) or information contained herein without notice.

## Electrical Specifications: $T_A = +25^\circ\text{C}$

Parameter	Test Conditions	Frequency	Units	Min	Typ	Max
Insertion Loss	—	DC - 3.5 GHz	dB	—	2.8	3.2
Attenuation Accuracy	Individual Bits 0.5-1-4-8 dB Individual Bit 2 dB Any Combination of Bits 1 to 15.5 dB	DC - 3.5 GHz DC - 3.5 GHz DC - 3.5 GHz	dB dB dB	— — —	— — —	$\pm(3 + 5\%$ of atten setting) $\pm(4 + 10\%$ of atten setting) $\pm(5 + 7\%$ of atten setting)
VSWR	Full Range	DC - 3.5 GHz	Ratio	—	1.6:1	1.8:1
Switching Speed	50% Cntl to 90%/10% RF 10% to 90% or 90% to 10%	— —	ns ns	— —	75 20	150 50
1 dB Compression	— —	50 MHz 0.5 - 3.5 GHz	dBm dBm	— —	+21 +29	— —
Input $IP_3$	Two-tone inputs up to +5 dBm	50 MHz 0.5-3.5 GHz	dB dB	— —	+35 +48	— —
$V_{CC}$	—	—	V	4.75	5.0	5.25
$V_{IL}$ $V_{IH}$	LOW-level input voltage HIGH-level input voltage	— —	V V	0.0 2.0	— —	0.8 5.0
$I_{in}$ (Input Leakage Current)	$V_{in} = V_{CC}$ or GND	—	$\mu\text{A}$	-1.0	—	1.0
$I_{CC}^4$	$V_{CC}$ min to max, Logic "0" or "1"	—	mA	—	6	10
Turn-on Current <sup>5</sup>	For guaranteed start-up	—	mA	—	—	125
$\Delta I_{CC}$ (Additional Supply Current Per TTL Input Pin)	$V_{CC} = \text{Max}$ , $V_{cntrl} = V_{CC} - 2.1 \text{ V}$	—	mA	—	—	1.0
Switching Noise	Generated from DC-DC Converter with recommended capacitors	3.5 MHz	dBm	—	-93	—
Thermal Resistance $\theta_{jc}$	—	—	$^\circ\text{C/W}$	—	15	—

- During turn-on, the device requires an initial start up current ( $I_{CC}$ ) specified as "Turn-on Current". Once operational,  $I_{CC}$  will drop to the specified levels.
- The DC-DC converter is guaranteed to start in 100  $\mu\text{s}$  as long as the power supplies have the maximum turn-on current available for start-up.

## Absolute Maximum Ratings<sup>6,7</sup>

Parameter	Absolute Maximum
Max. Input Power 0.05 GHz 0.5 - 3.5 GHz	+27 dBm +34 dBm
$V_{CC}$	$-0.5\text{V} \leq V_{CC} \leq +6.0\text{V}$
$V_{in}^8$	$-0.5\text{V} \leq V_{in} \leq V_{CC} + 0.5\text{V}$
Operating Temperature	$-40^\circ\text{C}$ to $+85^\circ\text{C}$
Storage Temperature	$-65^\circ\text{C}$ to $+125^\circ\text{C}$

- Exceeding any one or combination of these limits may cause permanent damage to this device.
- M/A-COM does not recommend sustained operation near these survivability limits.
- Standard CMOS TTL interface, latch-up will occur if logic signal is applied prior to power supply.

## Handling Procedures

Please observe the following precautions to avoid damage:

## Static Sensitivity

Gallium Arsenide Integrated Circuits are sensitive to electrostatic discharge (ESD) and can be damaged by static electricity. Proper ESD control techniques should be used when handling these devices.

## Moisture Sensitivity

The MSL rating for this part is defined as Level 2 per IPC/JEDEC J-STD-020. Parts shall be stored and/or baked as required for MSL Level 2 parts.

## Recommended PCB Configuration<sup>9</sup>

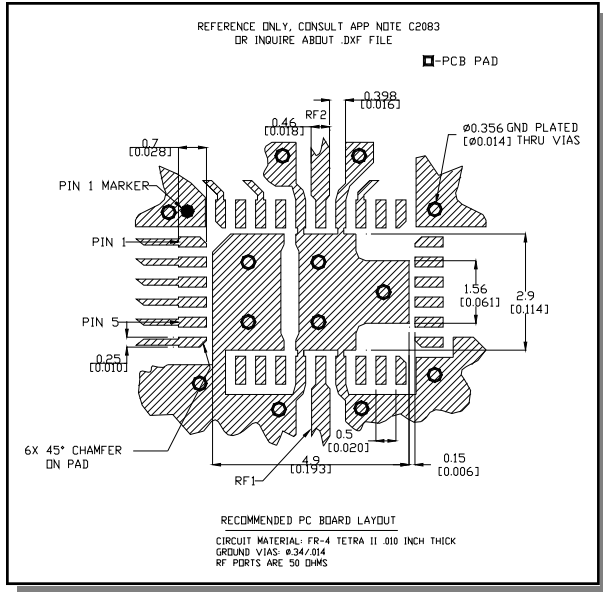

9. Application Note C2083 is available on line at [www.macom.com](http://www.macom.com)

## Truth Table (Digital Attenuator)

C8	C4	C2	C1	C0.5	Attenuation
0	0	0	0	0	Loss, Reference
0	0	0	0	1	0.5 dB
0	0	0	1	0	1.0 dB
0	0	1	0	0	2.0 dB
0	1	0	0	0	4.0 dB
1	0	0	0	0	8.0 dB
1	1	1	1	1	15.5 dB

0 = TTL Low; 1 = TTL High

## Typical Performance Curves

### Insertion Loss

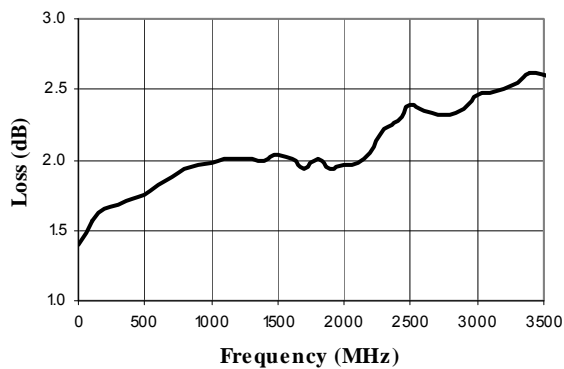

### VSWR @ Insertion Loss

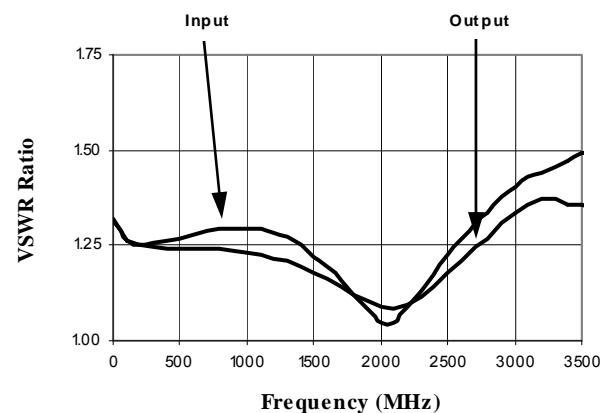

## Typical Performance Curves

**Attenuation Error, 0.5 dB Bit**

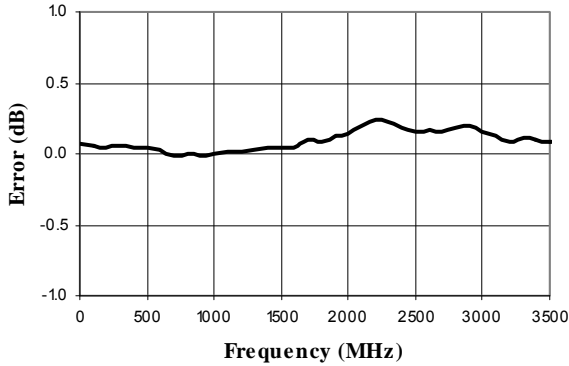

**Attenuation Error, 1 dB Bit**

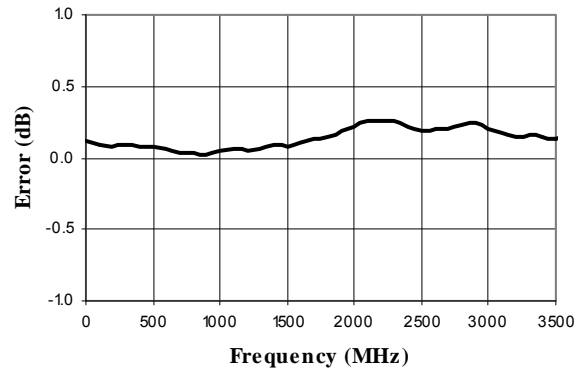

**Attenuation Error, 2 dB Bit**

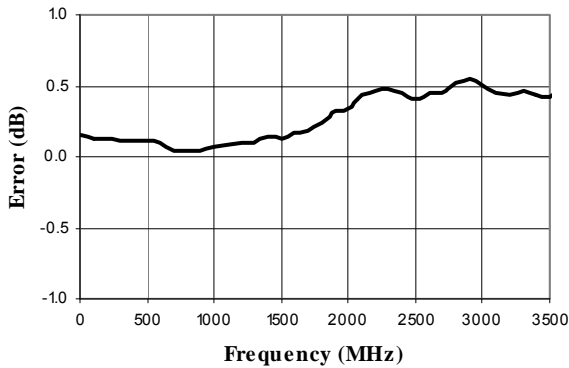

**Attenuation Error, 4 dB Bit**

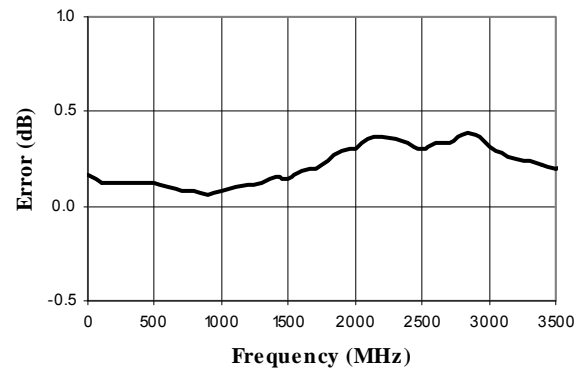

**Attenuation Error, 8 dB Bit**

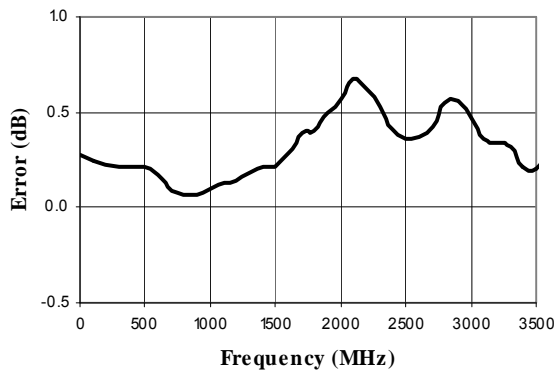

**Attenuation Error, Max. Attenuation**

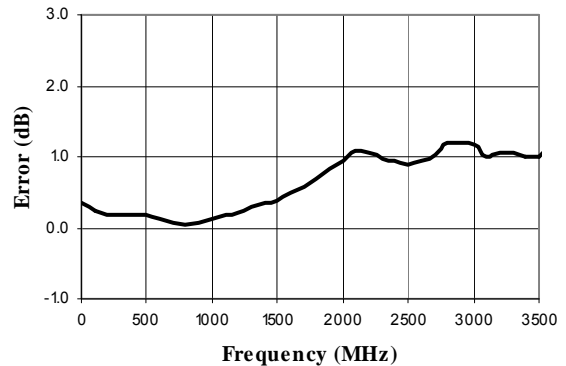

## Typical Performance Curves

VSWR, 0.5 dB Bit

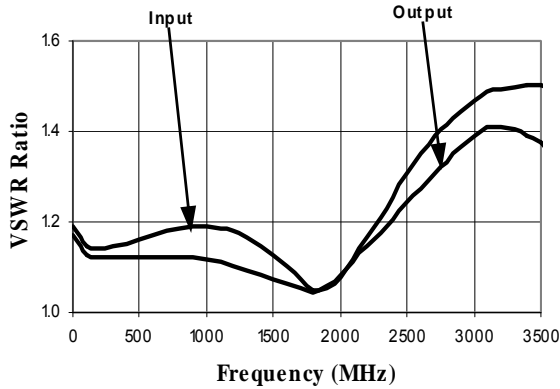

VSWR, 1 dB Bit

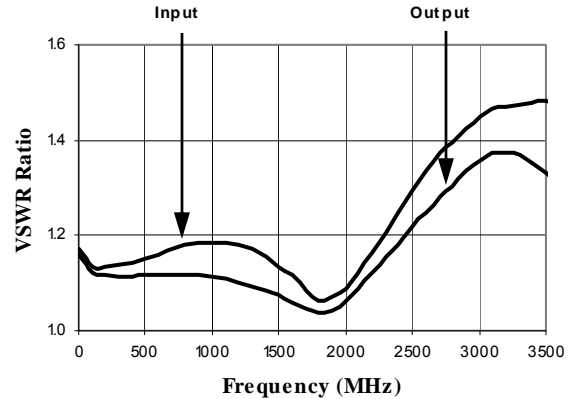

VSWR, 2 dB Bit

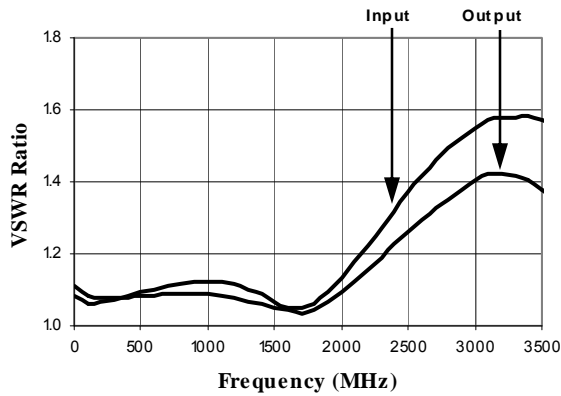

VSWR, 4 dB Bit

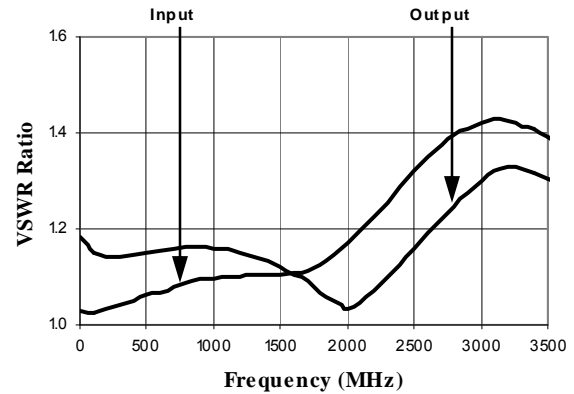

VSWR, 8 dB Bit

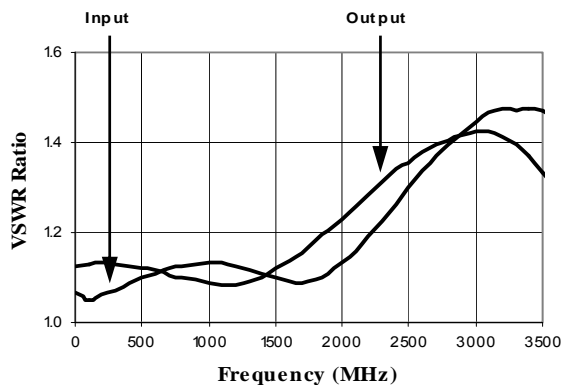

VSWR, Maximum Attenuation

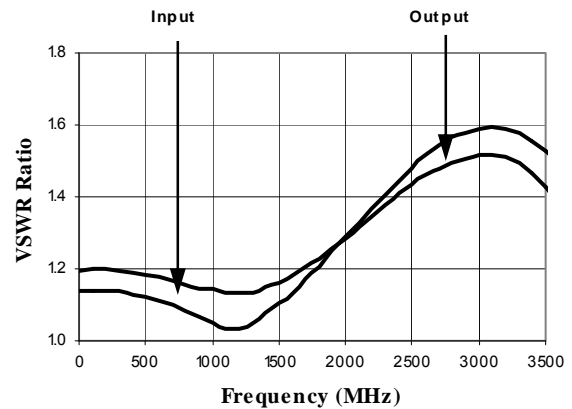

# AT90-1283

Digital Attenuator  
15.5 dB, 5-Bit, TTL Driver, DC-3.5 GHz

Rev. V11

## CSP-1, 4 x 6 mm, 32-lead PQFN†

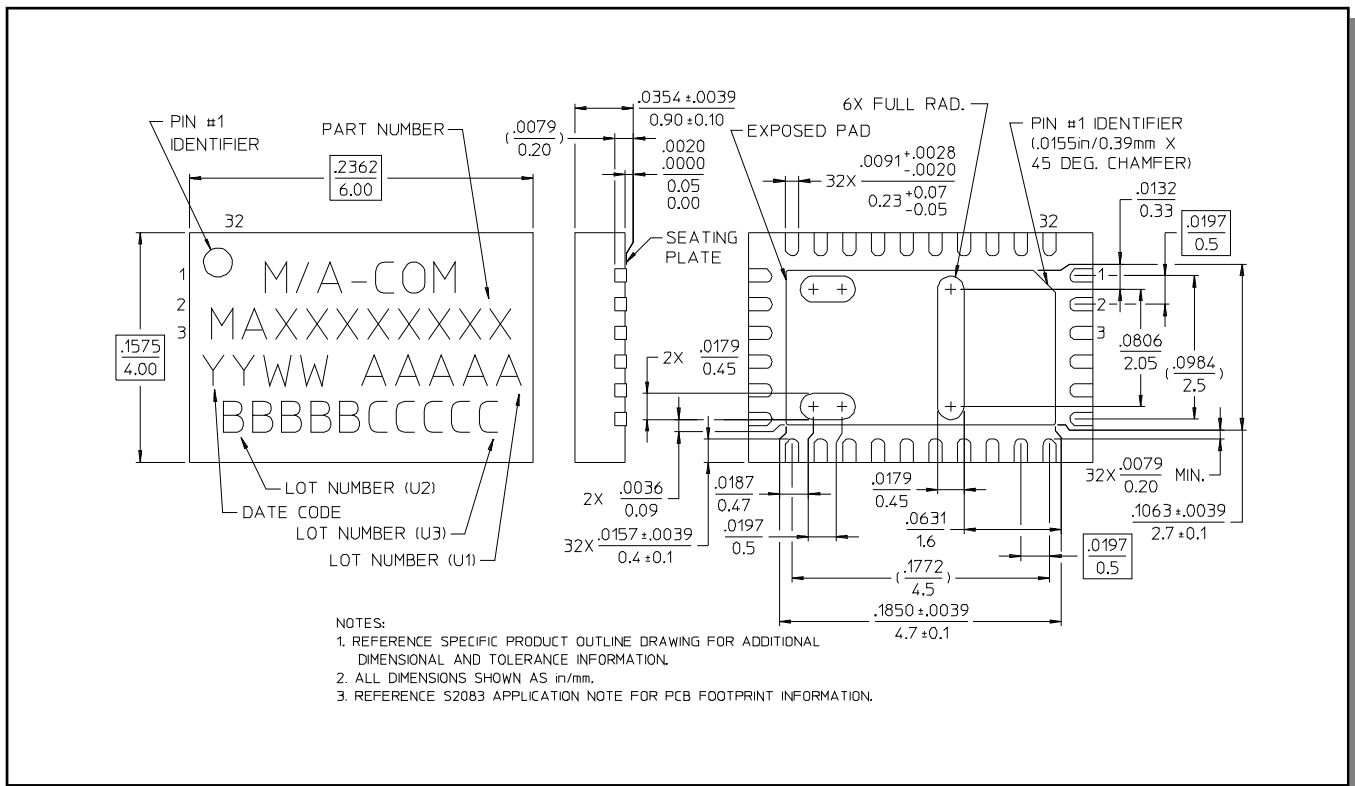

† Reference Application Note M538 for lead-free solder reflow recommendations.