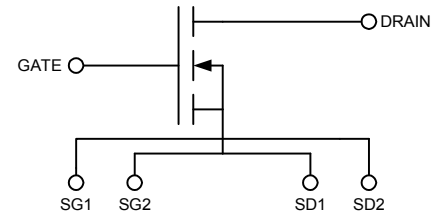

N-Channel Enhancement Mode  
 Low  $Q_g$  and  $R_g$   
 High  $dv/dt$   
 Nanosecond Switching  
 Ideal for Class C, D, & E Applications

$V_{DSS} = 200 \text{ V}$   
 $I_{D25} = 25 \text{ A}$   
 $R_{DS(on)} = 0.13 \Omega$   
 $P_{DC} = 590 \text{ W}$

Symbol	Test Conditions	Maximum Ratings	
$V_{DSS}$	$T_J = 25^\circ\text{C}$ to $150^\circ\text{C}$	200	V
$V_{DGR}$	$T_J = 25^\circ\text{C}$ to $150^\circ\text{C}$ ; $R_{GS} = 1 \text{ M}\Omega$	200	V
$V_{GS}$	Continuous	$\pm 20$	V
$V_{GSM}$	Transient	$\pm 30$	V
$I_{D25}$	$T_c = 25^\circ\text{C}$	25	A
$I_{DM}$	$T_c = 25^\circ\text{C}$ , pulse width limited by $T_{JM}$	150	A
$I_{AR}$	$T_c = 25^\circ\text{C}$	25	A
$E_{AR}$	$T_c = 25^\circ\text{C}$	20	mJ
$dv/dt$	$I_S \leq I_{DM}$ , $di/dt \leq 100 \text{ A}/\mu\text{s}$ , $V_{DD} \leq V_{DSS}$ , $T_J \leq 150^\circ\text{C}$ , $R_G = 0.2 \Omega$	5	V/ns
	$I_S = 0$	>200	V/ns
$P_{DC}$		590	W
$P_{DHS}$	$T_c = 25^\circ\text{C}$ Derate $1.9 \text{ W}/^\circ\text{C}$ above $25^\circ\text{C}$	284	W
$P_{DAMB}$	$T_c = 25^\circ\text{C}$	3.0	W
$R_{thJC}$		0.25	C/W
$R_{thJHS}$		0.53	C/W

**Features**

- Isolated Substrate
  - high isolation voltage (>2500V)
  - excellent thermal transfer
  - Increased temperature and power cycling capability
- IXYS advanced low  $Q_g$  process
- Low gate charge and capacitances
  - easier to drive
  - faster switching
- Low  $R_{DS(on)}$
- Very low insertion inductance (<2nH)
- No beryllium oxide (BeO) or other hazardous materials

**Advantages**

- Optimized for RF and high speed switching at frequencies to 100MHz
- Easy to mount—no insulators needed
- High power density

Symbol	Test Conditions	Characteristic Values		
		min.	typ.	max.
$T_J = 25^\circ\text{C}$ unless otherwise specified				
$V_{DSS}$	$V_{GS} = 0 \text{ V}$ , $I_D = 3 \text{ ma}$	200		V
$V_{GS(th)}$	$V_{DS} = V_{GS}$ , $I_D = 250 \mu\text{A}$	2.5	3.0	5.5 V
$I_{GSS}$	$V_{GS} = \pm 20 \text{ V}_{DC}$ , $V_{DS} = 0$			$\pm 100 \text{ nA}$
$I_{DSS}$	$V_{DS} = 0.8 V_{DSS}$ , $T_J = 25^\circ\text{C}$ $V_{GS} = 0$ , $T_J = 125^\circ\text{C}$			50 $\mu\text{A}$
				1 mA
$R_{DS(on)}$	$V_{GS} = 15 \text{ V}$ , $I_D = 0.5 I_{D25}$ Pulse test, $t \leq 300 \mu\text{s}$ , duty cycle $d \leq 2\%$			.13 $\Omega$
$g_{fs}$	$V_{DS} = 15 \text{ V}$ , $I_D = 0.5 I_{D25}$ , pulse test	13	16	18 S
$T_J$		-55		+175 $^\circ\text{C}$
$T_{JM}$			175	$^\circ\text{C}$
$T_{stg}$		-55		+175 $^\circ\text{C}$
$T_L$	1.6mm(0.063 in) from case for 10 s		300	$^\circ\text{C}$
<b>Weight</b>			2	g

Symbol	Test Conditions	Characteristic Values		
		(T <sub>J</sub> = 25°C unless otherwise specified)		
		min.	typ.	max.
R <sub>G</sub>			0.3	Ω
C <sub>iss</sub>			2500	pF
C <sub>oss</sub>	V <sub>GS</sub> = 0 V, V <sub>DS</sub> = 0.8 V <sub>DSS(max)</sub> , f = 1 MHz		265	pF
C <sub>rss</sub>			42	pF
C <sub>stray</sub>	Back Metal to any Pin		21	pF
T <sub>d(on)</sub>			5	ns
T <sub>on</sub>	V <sub>GS</sub> = 15 V, V <sub>DS</sub> = 0.8 V <sub>DSS</sub> I <sub>D</sub> = 0.5 I <sub>DM</sub>		5	ns
T <sub>d(off)</sub>	R <sub>G</sub> = 0.2 Ω (External)		8	ns
T <sub>off</sub>			8	ns
Q <sub>g</sub>			81	nC
Q <sub>gs</sub>	V <sub>GS</sub> = 10 V, V <sub>DS</sub> = 0.5 V <sub>DSS</sub> I <sub>D</sub> = 0.5 I <sub>D25</sub>		14	nC
Q <sub>gd</sub>			42	nC

**Source-Drain Diode**
**Characteristic Values**

 (T<sub>J</sub> = 25°C unless otherwise specified)

Symbol	Test Conditions	Characteristic Values		
		(T <sub>J</sub> = 25°C unless otherwise specified)		
		min.	typ.	max.
I <sub>S</sub>	V <sub>GS</sub> = 0 V			25 A
I <sub>SM</sub>	Repetitive; pulse width limited by T <sub>JM</sub>			150 A
V <sub>SD</sub>	I <sub>F</sub> = I <sub>S</sub> , V <sub>GS</sub> = 0 V, Pulse test, t ≤ 300 μs, duty cycle ≤ 2%			2.0 V
T <sub>rr</sub>			300	ns

CAUTION: Operation at or above the Maximum Ratings values may impact device reliability or cause permanent damage to the device.

Information in this document is believed to be accurate and reliable. IXYSRF reserves the right to make changes to information published in this document at any time and without notice.

For detailed device mounting and installation instructions, see the “*Device Installation & Mounting Instructions*” technical note on the IXYSRF web site at;

[http://www.ixysrf.com/pdf/switch\\_mode/appnotes/7de\\_series\\_mosfet\\_installation\\_instructions.pdf](http://www.ixysrf.com/pdf/switch_mode/appnotes/7de_series_mosfet_installation_instructions.pdf)

IXYS RF reserves the right to change limits, test conditions and dimensions.

IXYS RF MOSFETS are covered by one or more of the following U.S. patents:

4,835,592	4,860,072	4,881,106	4,891,686	4,931,844	5,017,508
5,034,796	5,049,961	5,063,307	5,187,117	5,237,481	5,486,715
5,381,025	5,640,045				

Fig. 1

**Typical Transfer Characteristics**  
 $V_{DS} = 60V, PW = 4\mu S$

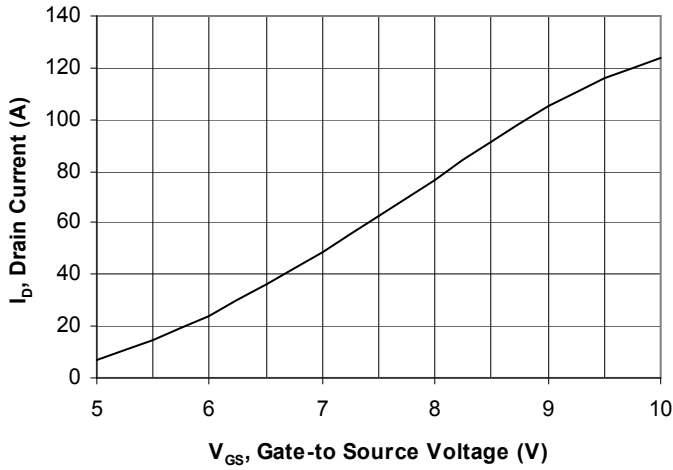

Fig. 2

**Typical Output Characteristics**

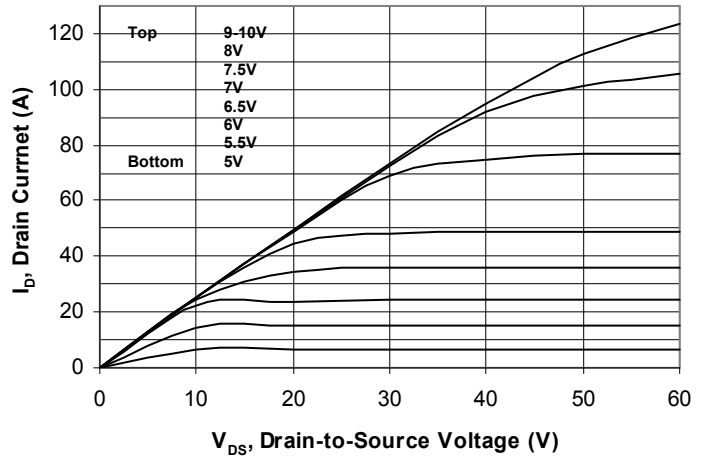

Fig. 3

**Gate Charge vs. Gate-to-Source Voltage**  
 $V_{DS} = 100V, I_D = 12.5A$

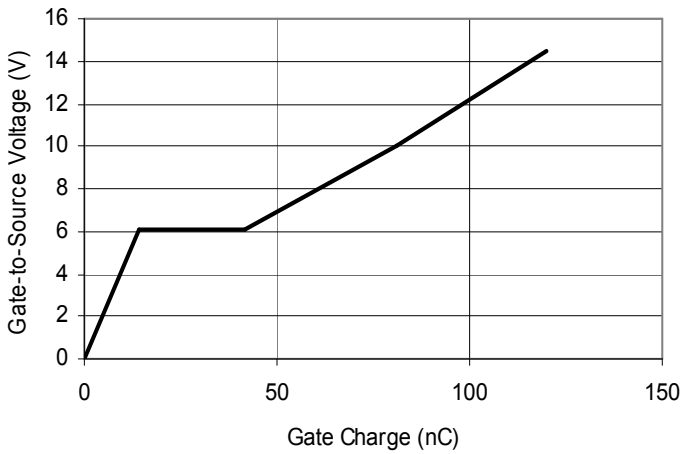
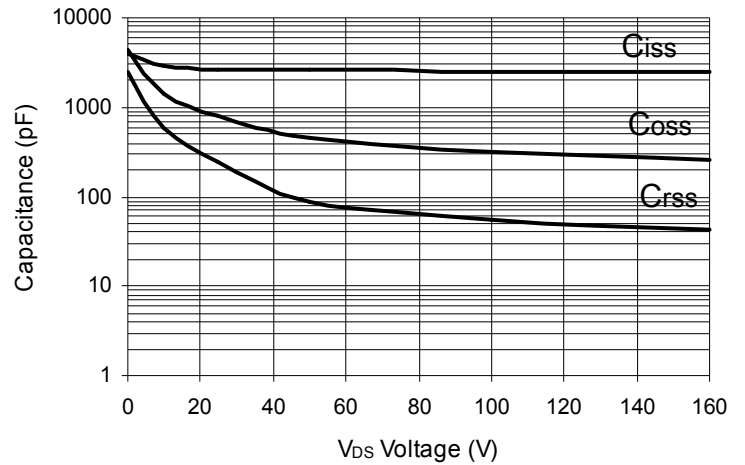
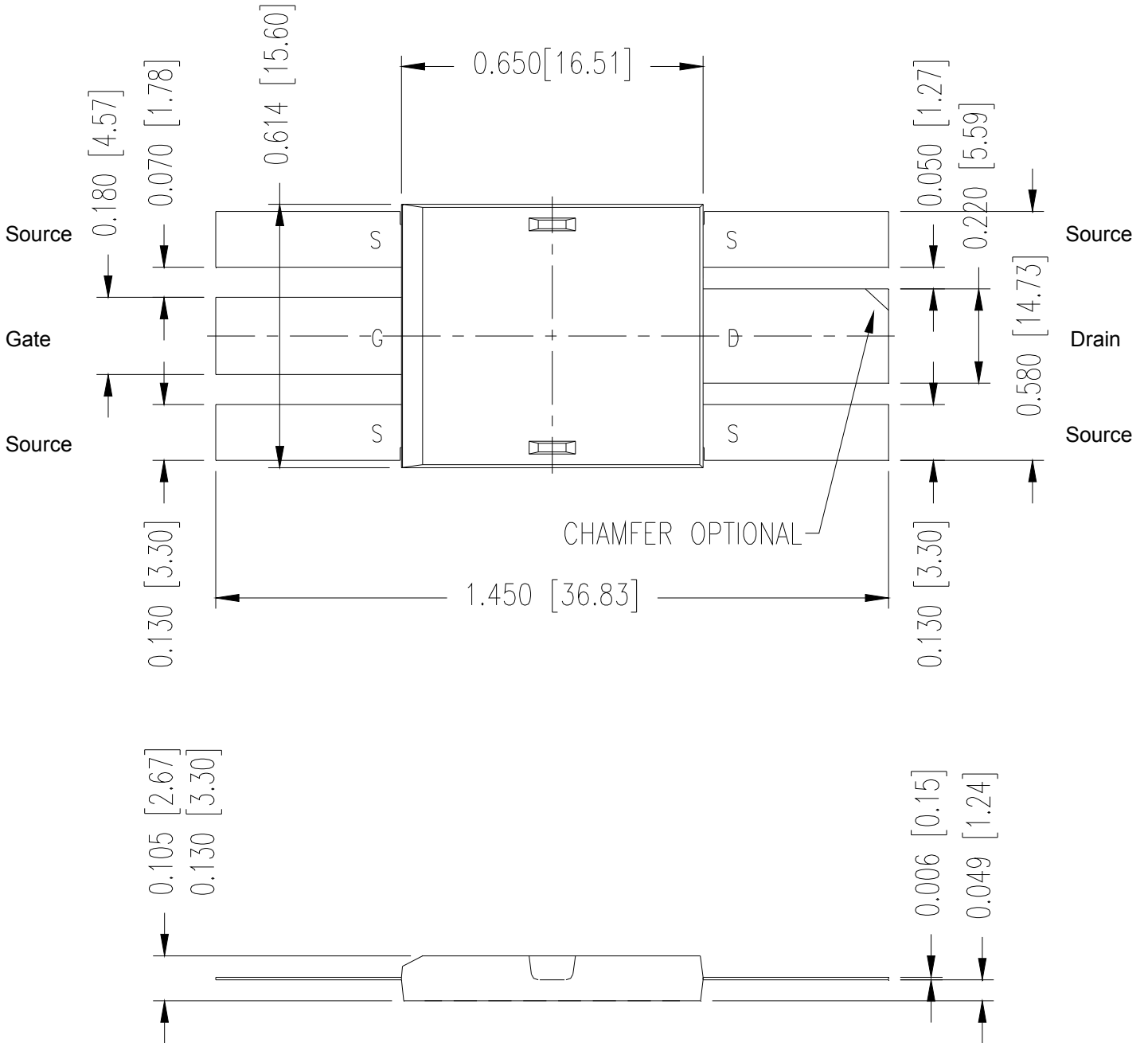

Fig. 4

**$V_{DS}$  vs. Capacitance**



**Fig. 5 Package Drawing**



**201N25A DE-SERIES SPICE Model**

The DE-SERIES SPICE Model is illustrated in Figure 1. The model is an expansion of the SPICE level 3 MOSFET model. It includes the stray inductive terms  $L_G$ ,  $L_S$  and  $L_D$ .  $R_d$  is the  $R_{DS(ON)}$  of the device,  $R_{ds}$  is the resistive leakage term. The output capacitance,  $C_{OSS}$ , and reverse transfer capacitance,  $C_{RSS}$  are modeled with reversed biased diodes. This provides a varactor type response necessary for a high power device model. The turn on delay and the turn off delay are adjusted via  $R_{on}$  and  $R_{off}$ .

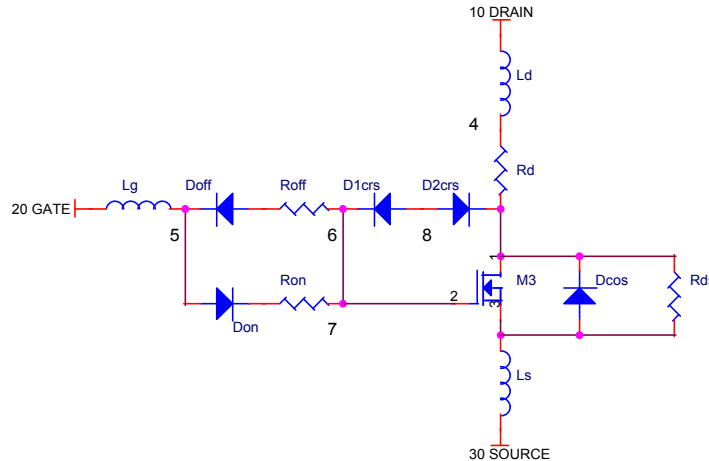

Figure 6 DE-SERIES SPICE Model

This SPICE model may be downloaded as a text file from the DEI web site at

[http://www.ixysrf.com/products/switch\\_mode.html](http://www.ixysrf.com/products/switch_mode.html)  
<http://www.ixysrf.com/spice/de275-201n25a.html>

**Net List:**

```
*****
*SYM=POWMOSN
.SUBCKT 201N25A 10 20 30
* TERMINALS: D G S
* 200 Volt 25 Amp .13 ohm N-Channel Power MOSFET
M1 12 3 3 DMOS L=1U W=1U
RON 5 6 1.5
DON 6 2 D1
ROF 5 7 .2
DOF 2 7 D1
D1CRS 2 8 D2
D2CRS 1 8 D2
CGS 2 3 2.5N
RD 4 1 .13
DCOS 3 1 D3
RDS 1 3 5.0MEG
LS 3 30 .1N
LD 10 4 1N
LG 20 5 1N
.MODEL DMOS NMOS (LEVEL=3 VTO=3.0 KP=25.0)
.MODEL D1 D (IS=.5F CJO=1P BV=100 M=.5 VJ=.6 TT=1N)
.MODEL D2 D (IS=.5F CJO=1100P BV=200 M=.5 VJ=.6 TT=1N RS=10M)
.MODEL D3 D (IS=.5F CJO=300P BV=200 M=.3 VJ=.4 TT=400N RS=10M)
.ENDS
```

Doc #9200-0260 Rev 4  
© 2009 IXYS RF



An IXYS Company  
2401 Research Blvd., Suite 108  
Fort Collins, CO USA 80526  
970-493-1901 Fax: 970-493-1903  
Email: [sales@ixyscolorado.com](mailto:sales@ixyscolorado.com)  
Web: <http://www.ixyscolorado.com>