



Technical Data Sheet

Bi-Color (Multi-Color) Top View LEDs

67-22UYOSYGC/S530-A3/E2/TR8

Features

- P-LCC-4 package.
- White package
- Optical indicator.
- Colorless clear window.
- Ideal for backlight and light pipe application.
- Inter reflector.
- Low (2mA) current operation.
- Wide viewing angle.
- Computable with automatic placement equipment.
- Suitable for vapor-phase reflow, Infrared reflow and wave solder processes.
- Available on tape and reel (8mm Tape).
- Pb-free
- The product itself will remain within RoHS compliant version.



Descriptions

- The 67-22 series is available in soft orange, green, blue and yellow. Due to the package design, the LED has wide viewing angle and optimized light coupling by inter reflector, this feature makes the ideal for light pipe application. The low current requirement makes this device ideal for portable equipment or any other application where power is at a premium.

Applications

- Automotive: backlight in dashboards and switches.
- Telecommunication: indicator and backlight in telephone and fax.
- Indicator and backlight for audio and video equipment.
- Indicator and backlight in office and family equipment.
- Flat backlight for LCD's, switches and symbols.
- Light pipe application.
- General use.

Device Selection Guide

Chip			Lens Color
Type	Material	Emitted Color	
UYO	AlGaInP	Brilliant Orange	Water Clear
SYG	AlGaInP	Brilliant Yellow Green	

67-22UYOSYGC/S530-A3/E2/TR8

Package Dimensions

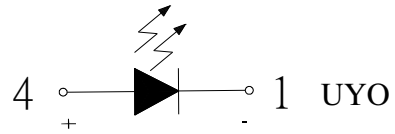
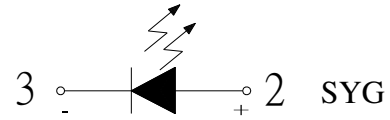
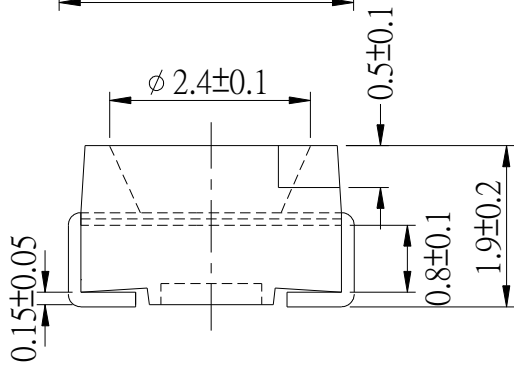
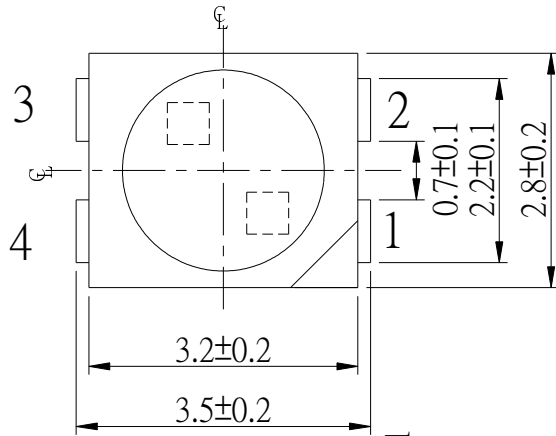

Polarity

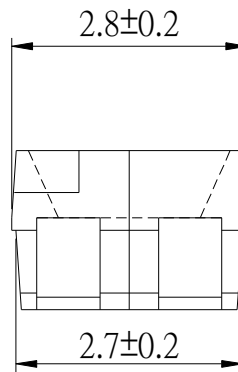

For reflow soldering(propose)

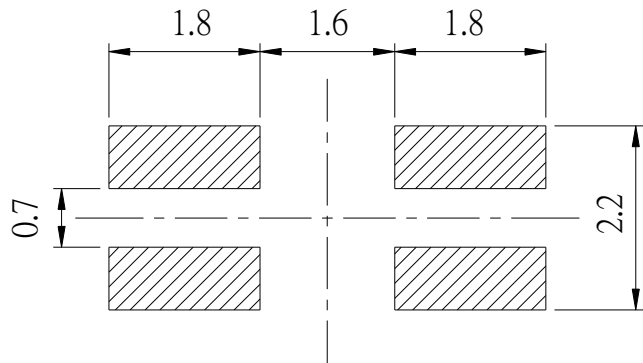
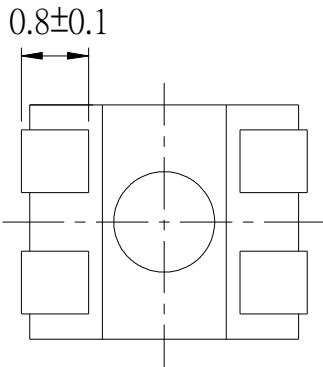

- Notes:** 1.All dimensions are in millimeters.
2.Tolerances unspecified are ±0.1mm.

67-22UYOSYGC/S530-A3/E2/TR8
Absolute Maximum Ratings (Ta=25°C)

Parameter	Symbol	Rating	Unit
Reverse Voltage	V _R	5	V
Forward Current	I _F	UYO:25 SYG:25	mA
Operating Temperature	T _{opr}	-40 ~ +85	°C
Storage Temperature	T _{stg}	-40~ +100	°C
Electrostatic Discharge(HBM)	ESD	UYO:2000 SYG:2000	V
Power Dissipation	P _d	UYO:60 SYG:60	mW
Peak Forward Current (Duty 1/10 @ 1KHz)	I _{FP}	UYO:60 SYG:60	mA
Soldering Temperature	T _{sol}	Reflow Soldering : 260 °C for 10 sec. Hand Soldering : 350 °C for 3 sec.	

Electro-Optical Characteristics (Ta=25°C)

Parameter	Symbol	Min.	Typ.	Max.	Unit	Condition	
Luminous Intensity	I _v	UYO	36	90	-----	mcd	
		SYG	22	54	-----	mcd	
Viewing Angle	2θ 1/2	-----	130	-----	deg	I _F =20mA	
Peak Wavelength	λ _p	UYO	-----	611	-----	nm	I _F =20mA
		SYG	-----	575	-----		
Dominant Wavelength	λ _d	UYO	-----	605	-----	nm	I _F =20mA
		SYG	-----	573	-----		
Spectrum Radiation Bandwidth	Δλ	UYO	-----	20	-----	nm	I _F =20mA
		SYG	-----	20	-----		
Forward Voltage	V _F	UYO	1.7	2.0	2.4	V	I _F =20mA
		SYG	1.7	2.0	2.4		
Reverse Current	I _R	-----	-----	10	μA	V _R =5V	

67-22UYOSYGC/S530-A3/E2/TR8

Typical Electro-Optical Characteristics Curves

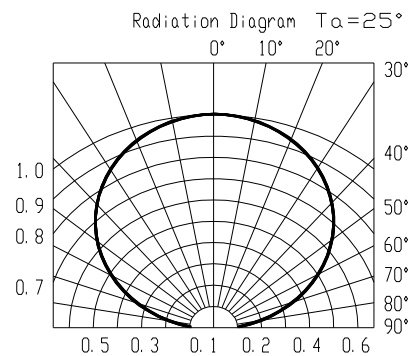
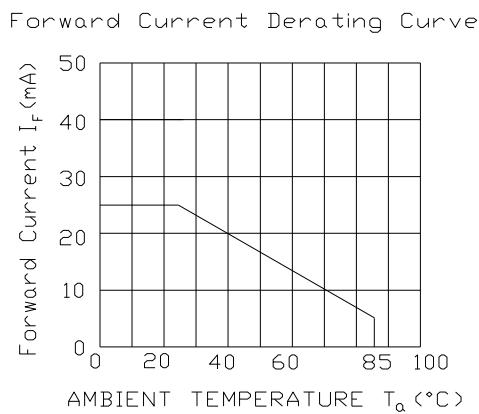
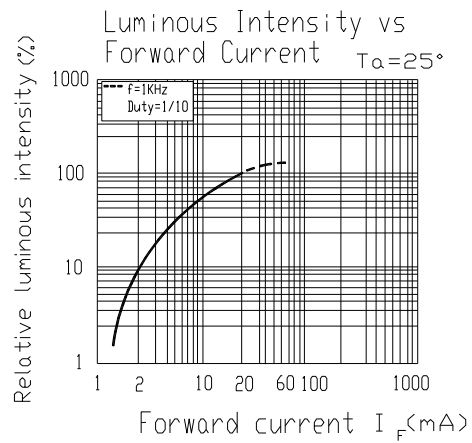
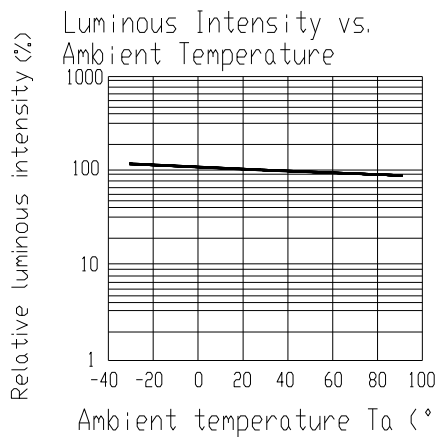
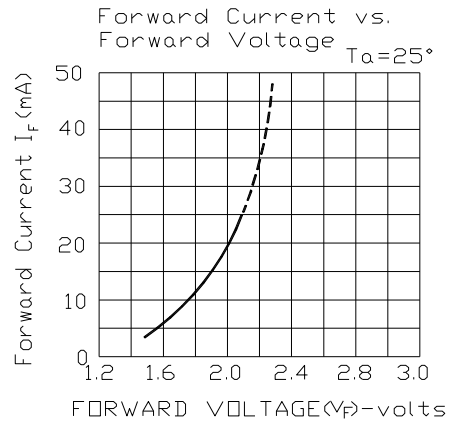
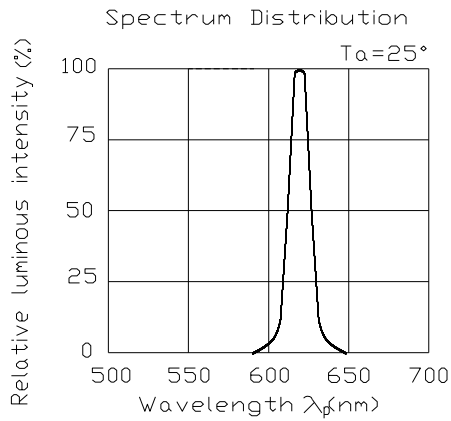

Typical Electro-Optical Characteristics Curves

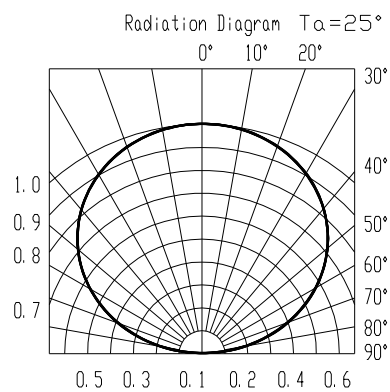
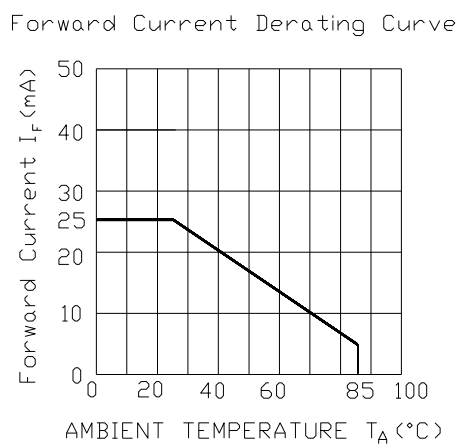
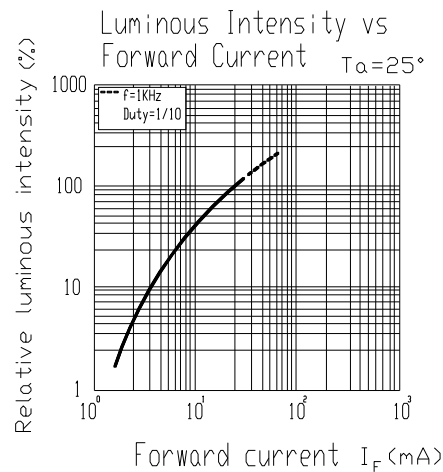
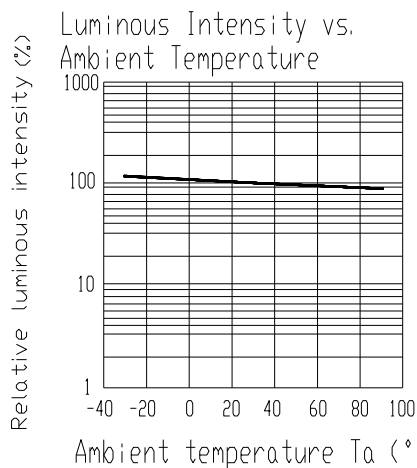
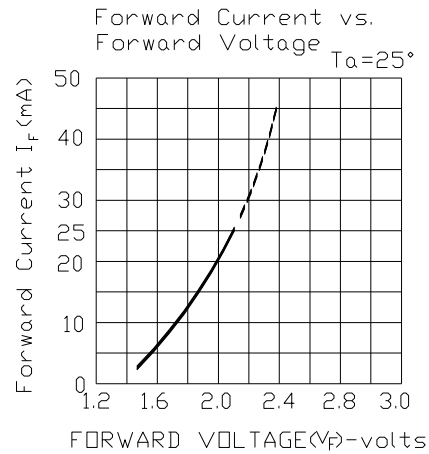
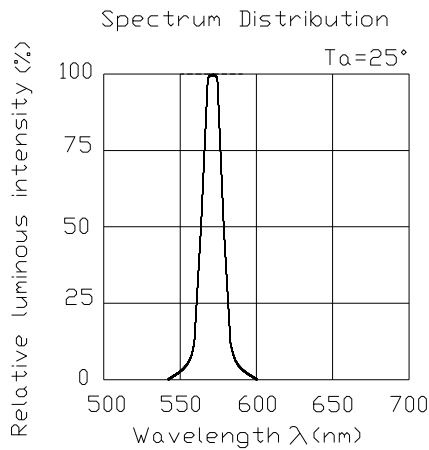

67-22UYOSYGC/S530-A3/E2/TR8

Label explanation

CAT: Luminous Intensity Rank

HUE: Dom. Wavelength Rank

REF: Forward Voltage Rank

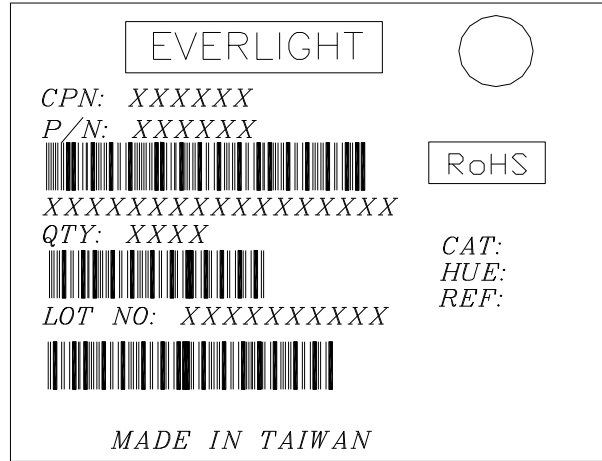

Reel Dimensions

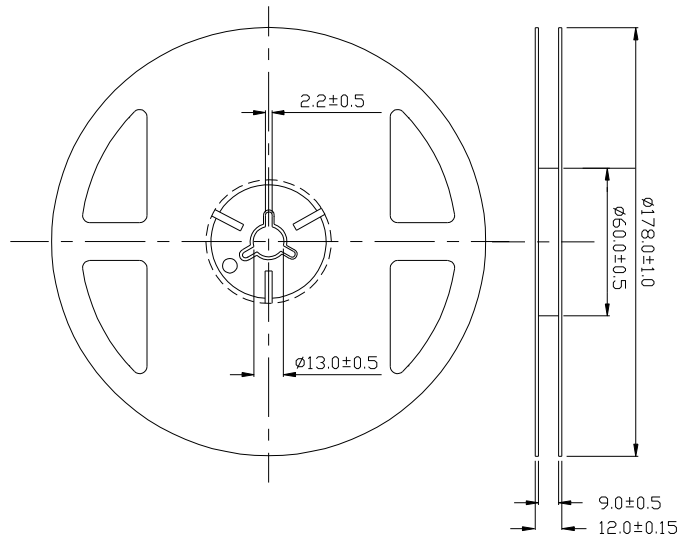

Note: The tolerances unless mentioned is $\pm 0.1\text{mm}$,Unit = mm

67-22UYOSYGC/S530-A3/E2/TR8

Carrier Tape Dimensions: Loaded quantity 2000 PCS per reel

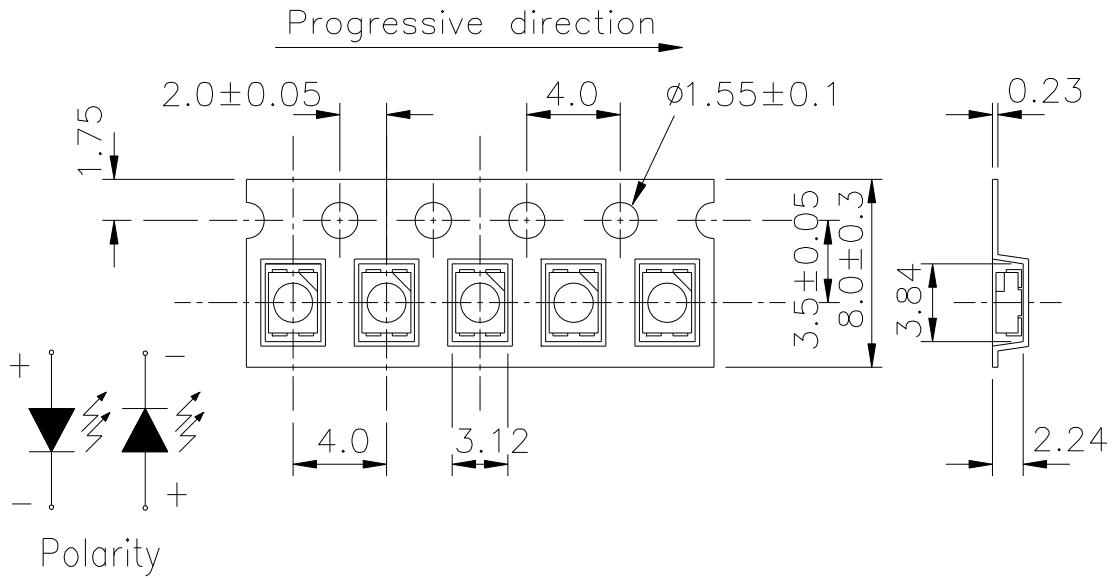

Note: The tolerances unless mentioned is $\pm 0.1\text{mm}$,Unit = mm

Moisture Resistant Packaging

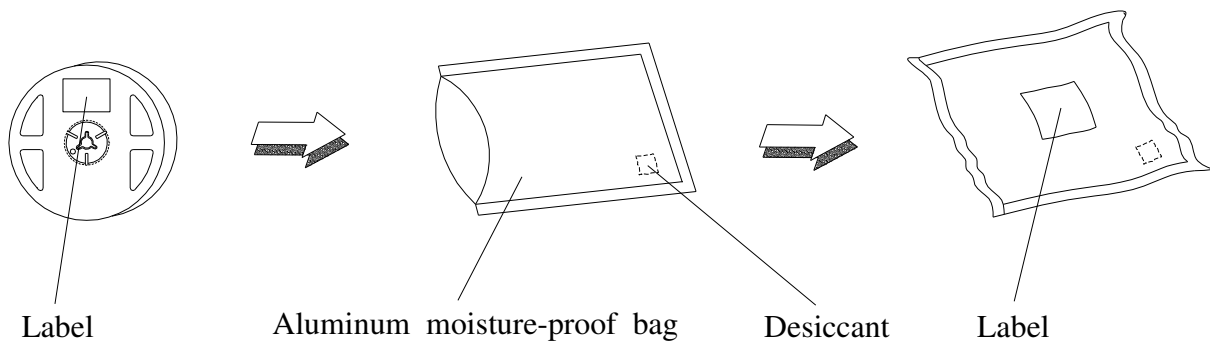

Reliability Test Items And Conditions

The reliability of products shall be satisfied with items listed below.

Confidence level : 90%

LTPD : 10%

No.	Items	Test Condition	Test Hours/Cycles	Sample Size	Ac/Re
1	Reflow Soldering	Temp. : 260°C ±5°C Min. 5sec.	6 Min.	22 PCS.	0/1
2	Temperature Cycle	H : +100°C 15min ∫ 5 min L : -40°C 15min	300 Cycles	22 PCS.	0/1
3	Thermal Shock	H : +100°C 5min ∫ 10 sec L : -10°C 5min	300 Cycles	22 PCS.	0/1
4	High Temperature Storage	Temp. : 100°C	1000 Hrs.	22 PCS.	0/1
5	Low Temperature Storage	Temp. : -40°C	1000 Hrs.	22 PCS.	0/1
6	DC Operating Life	IF = 20 mA	1000 Hrs.	22 PCS.	0/1
7	High Temperature / High Humidity	85°C / 85%RH	1000 Hrs.	22 PCS.	0/1

Precautions For Use

1. Over-current-proof

Customer must apply resistors for protection , otherwise slight voltage shift will cause big current change (Burn out will happen).

2. Storage

2.1 Do not open moisture proof bag before the products are ready to use.

2.2 Before opening the package, the LEDs should be kept at 30°C or less and 90%RH or less.

2.3 The LEDs should be used within a year.

2.4 After opening the package, the LEDs should be kept at 30°C or less and 70%RH or less.

2.5 The LEDs should be used within 168 hours (7 days) after opening the package.

2.6 If the moisture absorbent material (silica gel) has faded away or the LEDs have exceeded the storage time, baking treatment should be performed using the following conditions.

Baking treatment : 60±5°C for 24 hours.

3. Soldering Condition

3.1 Pb-free solder temperature profile

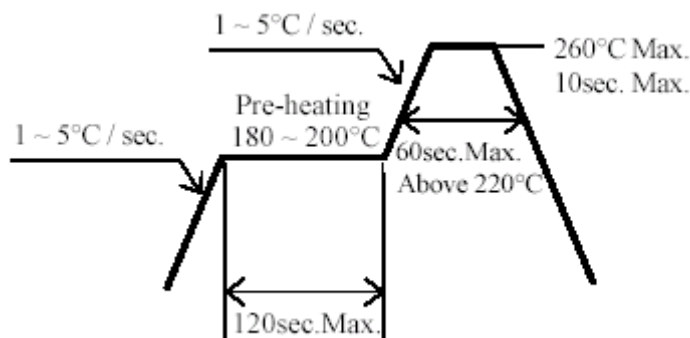

3.2 Reflow soldering should not be done more than two times.

3.3 When soldering, do not put stress on the LEDs during heating.

3.4 After soldering, do not warp the circuit board.

4.Soldering Iron

Each terminal is to go to the tip of soldering iron temperature less than 350°C for 3 seconds within once in less than the soldering iron capacity 25W. Leave two seconds and more intervals, and do soldering of each terminal. Be careful because the damage of the product is often started at the time of the hand solder.

5.Repairing

Repair should not be done after the LEDs have been soldered. When repairing is unavoidable, a double-head soldering iron should be used (as below figure). It should be confirmed beforehand whether the characteristics of the LEDs will or will not be damaged by repairing.

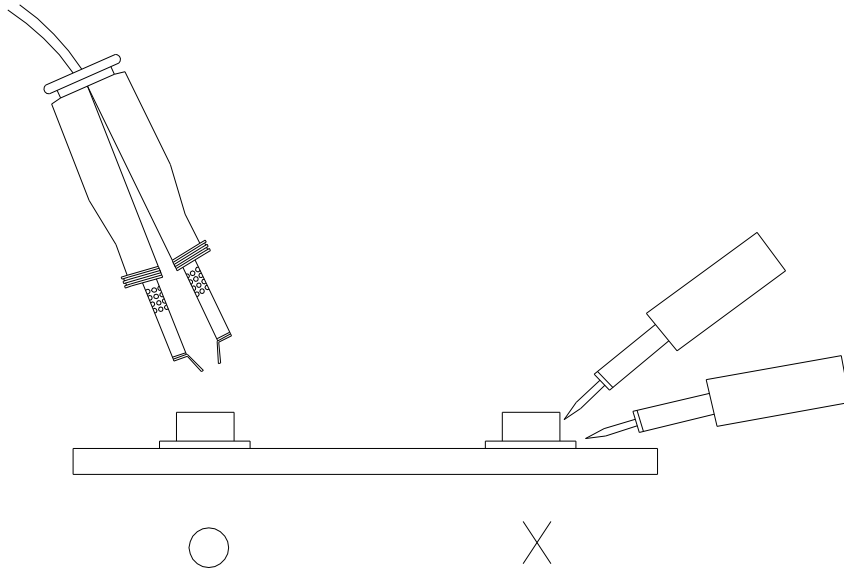

EVERLIGHT ELECTRONICS CO., LTD.
Office: No 25, Lane 76, Sec 3, Chung Yang Rd,
Tucheng, Taipei 236, Taiwan, R.O.C

Tel: 886-2-2267-2000, 2267-9936
Fax: 886-2267-6244, 2267-6189, 2267-6306
<http://www.everlight.com>