

**ISOTOP[®] Boost chopper
Super Junction
MOSFET Power Module**

$V_{DSS} = 600V$
 $R_{DSon} = 45m\Omega \text{ max @ } T_j = 25^\circ C$
 $I_D = 52A \text{ @ } T_c = 25^\circ C$

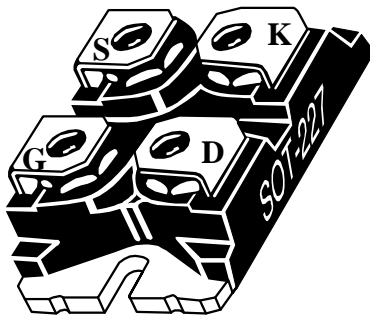
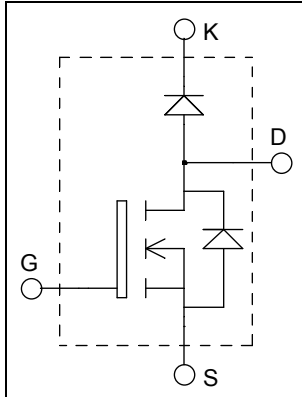

Application

- AC and DC motor control
- Switched Mode Power Supplies
- Power Factor Correction
- Brake switch

Features

- **COOLMOS[®]**
Power Semiconductors
 - Ultra low R_{DSon}
 - Low Miller capacitance
 - Ultra low gate charge
 - Avalanche energy rated
- ISOTOP[®] Package (SOT-227)
- Very low stray inductance
- High level of integration

Benefits

- Outstanding performance at high frequency operation
- Stable temperature behavior
- Very rugged
- Direct mounting to heatsink (isolated package)
- Low junction to case thermal resistance
- Easy paralleling due to positive TC of V_{CEsat}
- RoHS Compliant

Absolute maximum ratings

Symbol	Parameter	Max ratings	Unit
V_{DSS}	Drain - Source Breakdown Voltage	600	V
I_D	Continuous Drain Current	$T_c = 25^\circ C$	52
		$T_c = 80^\circ C$	38
I_{DM}	Pulsed Drain current	130	
V_{GS}	Gate - Source Voltage	± 20	V
R_{DSon}	Drain - Source ON Resistance	45	$m\Omega$
P_D	Maximum Power Dissipation	$T_c = 25^\circ C$	290
I_{AR}	Avalanche current (repetitive and non repetitive)	15	A
E_{AR}	Repetitive Avalanche Energy	3	mJ
E_{AS}	Single Pulse Avalanche Energy	1900	

 **CAUTION:** These Devices are sensitive to Electrostatic Discharge. Proper Handling Procedures Should Be Followed.

All ratings @ $T_j = 25^\circ\text{C}$ unless otherwise specified

Electrical Characteristics

Symbol	Characteristic	Test Conditions	Min	Typ	Max	Unit
I_{DSS}	Zero Gate Voltage Drain Current	$V_{GS} = 0V, V_{DS} = 600V$ $T_j = 25^\circ\text{C}$			250	μA
		$V_{GS} = 0V, V_{DS} = 600V$ $T_j = 125^\circ\text{C}$			500	
$R_{DS(on)}$	Drain – Source on Resistance	$V_{GS} = 10V, I_D = 22.5A$		40	45	$\text{m}\Omega$
$V_{GS(th)}$	Gate Threshold Voltage	$V_{GS} = V_{DS}, I_D = 3\text{mA}$	2.1	3	3.9	V
I_{GSS}	Gate – Source Leakage Current	$V_{GS} = \pm 20V, V_{DS} = 0V$			100	nA

Dynamic Characteristics

Symbol	Characteristic	Test Conditions	Min	Typ	Max	Unit
C_{iss}	Input Capacitance	$V_{GS} = 0V ; V_{DS} = 25V$ $f = 1\text{MHz}$		7.2		nF
C_{oss}	Output Capacitance			8.5		
Q_g	Total gate Charge	$V_{GS} = 10V$ $V_{Bus} = 300V$ $I_D = 49A$		150		nC
Q_{gs}	Gate – Source Charge			34		
Q_{gd}	Gate – Drain Charge			51		
$T_{d(on)}$	Turn-on Delay Time	Inductive Switching (125°C) $V_{GS} = 10V$ $V_{Bus} = 400V$ $I_D = 49A$ $R_G = 5\Omega$		21		ns
T_r	Rise Time			30		
$T_{d(off)}$	Turn-off Delay Time			100		
T_f	Fall Time			45		
E_{on}	Turn-on Switching Energy	Inductive switching @ 25°C $V_{GS} = 10V ; V_{Bus} = 400V$ $I_D = 49A ; R_G = 5\Omega$		675		μJ
E_{off}	Turn-off Switching Energy			520		
E_{on}	Turn-on Switching Energy	Inductive switching @ 125°C $V_{GS} = 10V ; V_{Bus} = 400V$ $I_D = 49A ; R_G = 5\Omega$		1100		μJ
E_{off}	Turn-off Switching Energy			635		
V_{SD}	Diode Forward Voltage	$V_{GS} = 0V, I_S = -49A$		0.9	1.2	V
t_{rr}	Reverse Recovery Time	$I_S = -49A$ $V_R = 400V$ $di_s/dt = 100A/\mu\text{s}$		600		ns
Q_{rr}	Reverse Recovery Charge		$T_j = 25^\circ\text{C}$		17	

Chopper diode ratings and characteristics

Symbol	Characteristic	Test Conditions	Min	Typ	Max	Unit	
V_{RRM}	Max. Peak Repetitive Reverse Voltage		600			V	
V_F	Diode Forward Voltage	$I_F = 30A$		1.8	2.2	V	
		$I_F = 60A$		2			
		$I_F = 30A$	$T_j = 125^\circ C$		1.3		
I_{RM}	Maximum Reverse Leakage Current	$V_R = 600V$	$T_j = 25^\circ C$		100	μA	
			$T_j = 125^\circ C$		500		
C_T	Junction Capacitance	$V_R = 200V$		36		pF	
t_{rr}	Reverse Recovery Time	$I_F = 1A, V_R = 30V$ $di/dt = 100A/\mu s$	$T_j = 25^\circ C$		22	ns	
				$T_j = 25^\circ C$			25
				$T_j = 125^\circ C$			160
I_{RRM}	Maximum Reverse Recovery Current	$I_F = 30A$ $V_R = 400V$ $di/dt = 200A/\mu s$	$T_j = 25^\circ C$		3	A	
				$T_j = 125^\circ C$			6
				$T_j = 25^\circ C$			35
Q_{rr}	Reverse Recovery Charge		$T_j = 25^\circ C$		480	nC	
				$T_j = 125^\circ C$			480
t_{rr}	Reverse Recovery Time	$I_F = 30A$	$T_j = 125^\circ C$		85	ns	
Q_{rr}	Reverse Recovery Charge	$V_R = 400V$			920	nC	
I_{RRM}	Maximum Reverse Recovery Current	$di/dt = 1000A/\mu s$			20	A	

Thermal and package characteristics

Symbol	Characteristic	Min	Typ	Max	Unit
R_{thJC}	Junction to Case Thermal Resistance	CoolMos		0.43	$^\circ C/W$
		Diode		1.1	
R_{thJA}	Junction to Ambient (IGBT & Diode)			20	$^\circ C/W$
V_{ISOL}	RMS Isolation Voltage, any terminal to case $t = 1$ min, $I_{isol} < 1mA$, 50/60Hz	2500			V
T_J, T_{STG}	Storage Temperature Range	-40		150	$^\circ C$
T_L	Max Lead Temp for Soldering: 0.063" from case for 10 sec			300	$^\circ C$
Torque	Mounting torque (Mounting = 8-32 or 4mm Machine and terminals = 4mm Machine)			1.5	N.m
Wt	Package Weight		29.2		g

SOT-227 (ISOTOP[®]) Package Outline

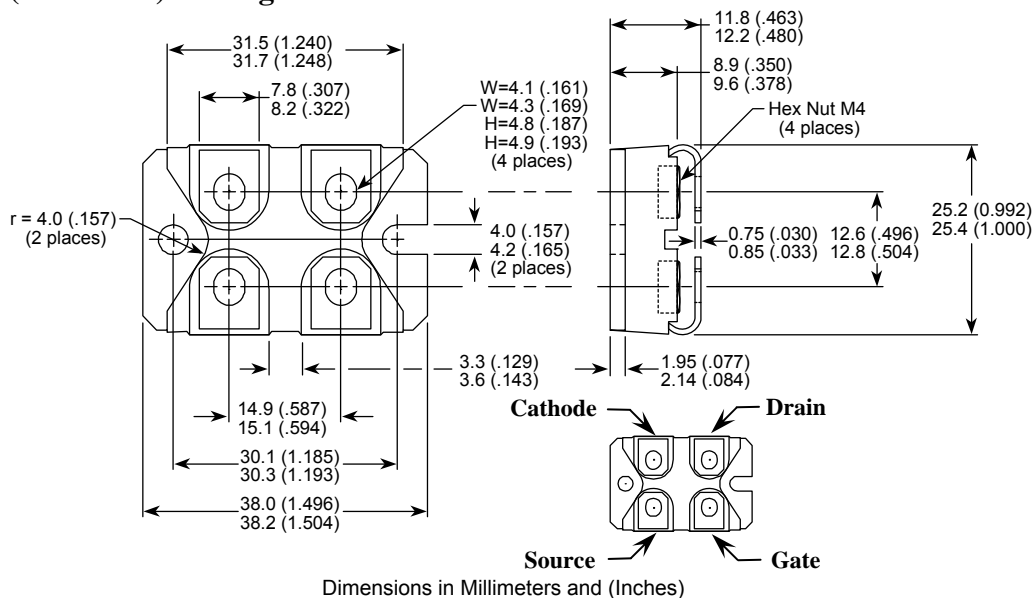

Typical Performance Curve

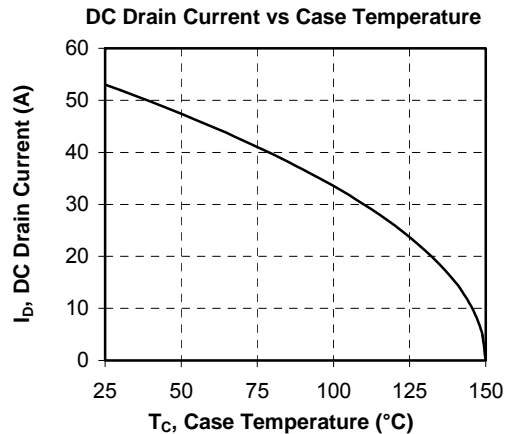
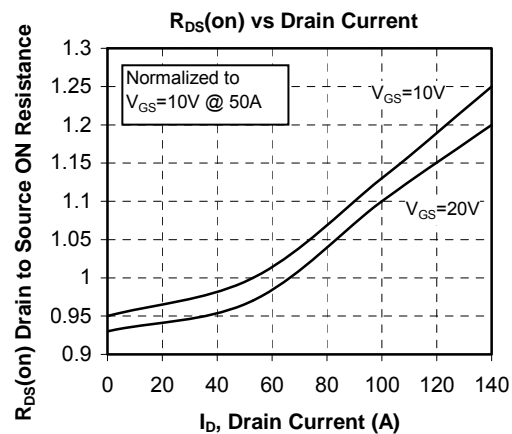
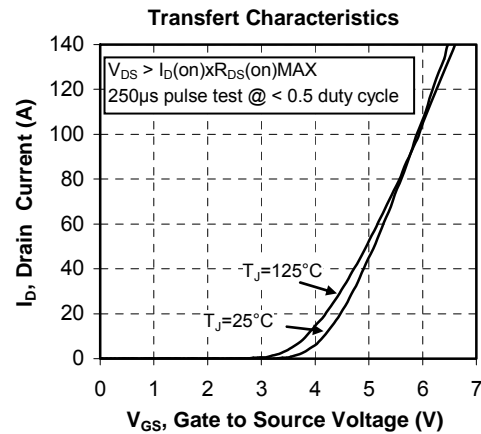
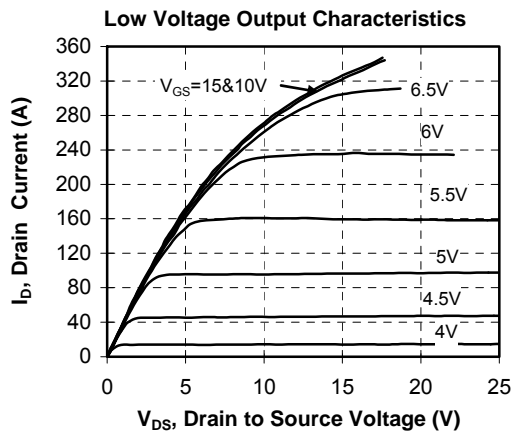
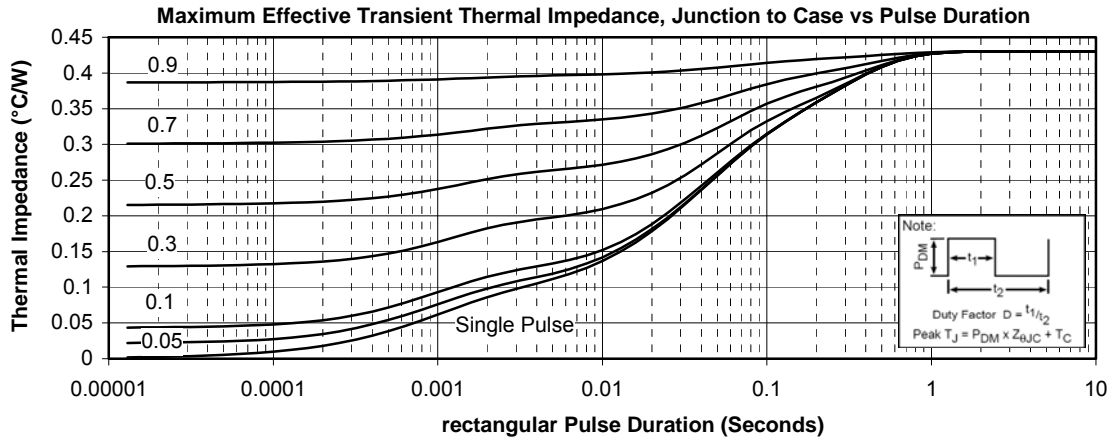

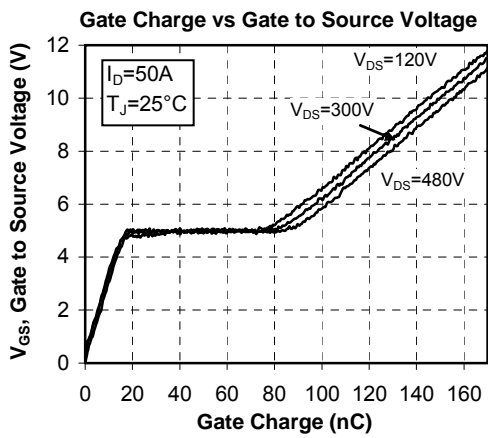
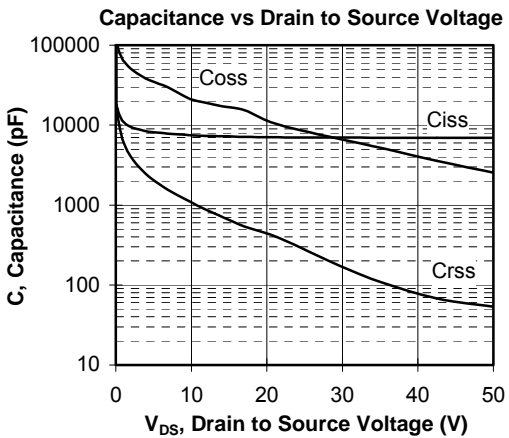
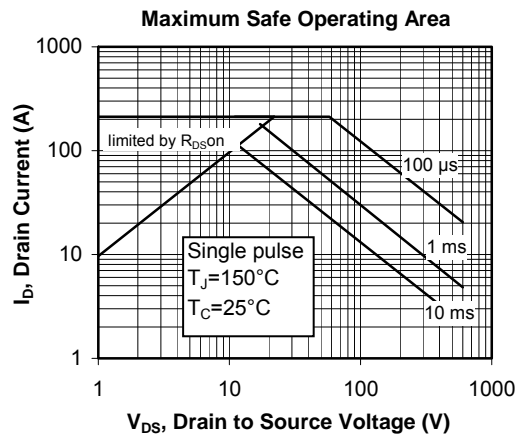
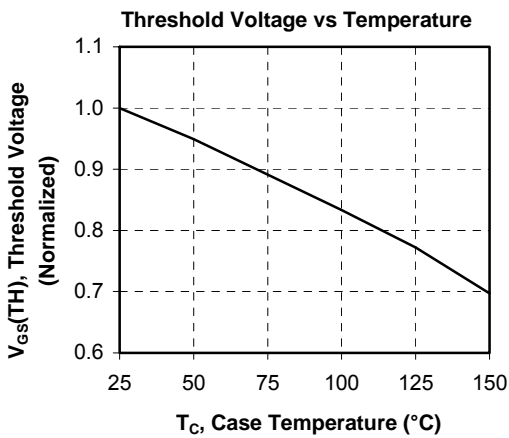
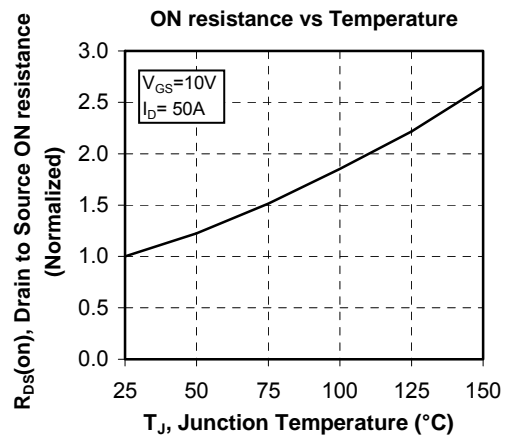
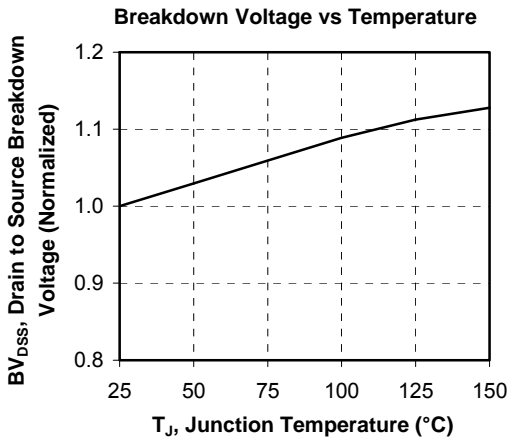

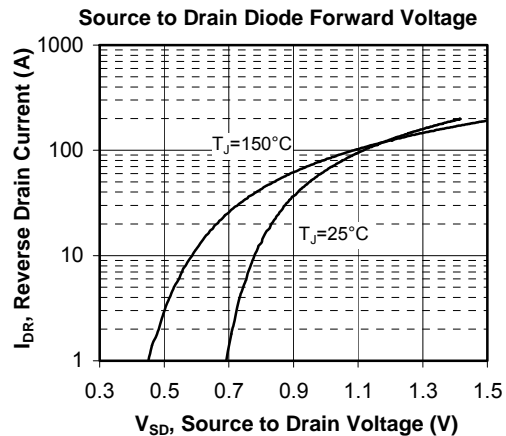
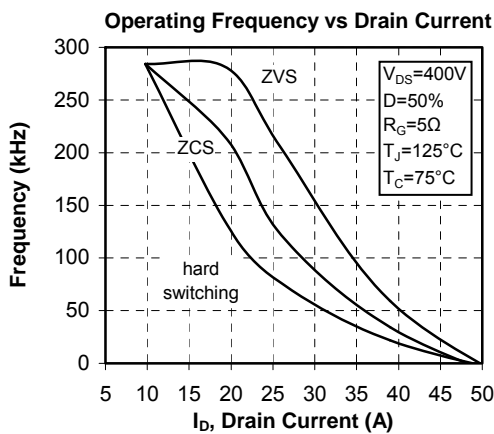
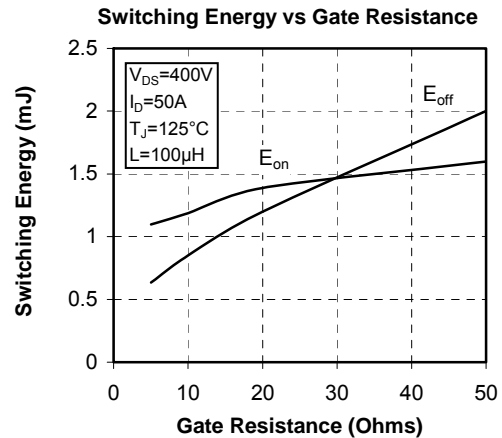
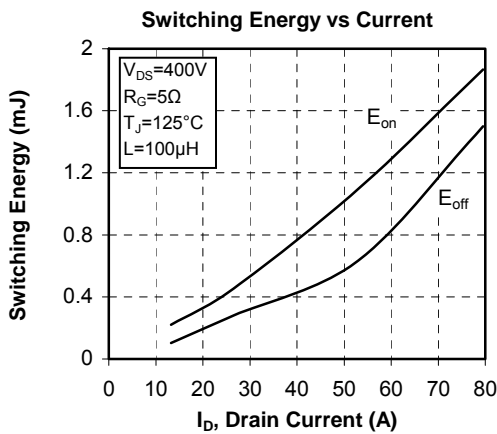
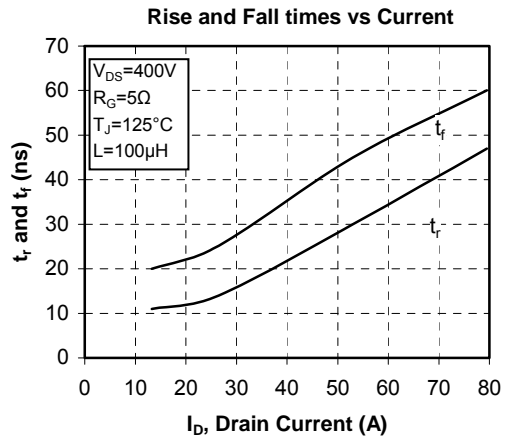
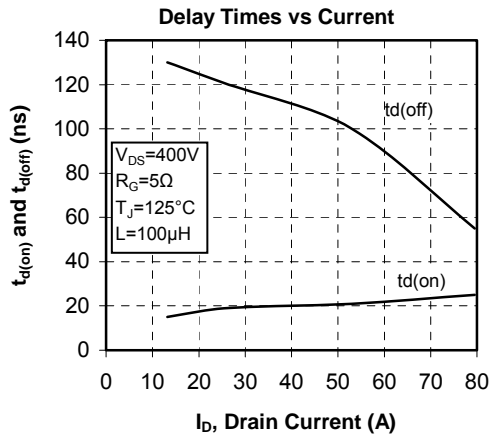

ISOTOP® is a registered trademark of ST Microelectronics NV

COOLMOS™ comprise a new family of transistors developed by Infineon Technologies AG. “COOLMOS” is a trademark of Infineon Technologies AG”.

Microsemi reserves the right to change, without notice, the specifications and information contained herein

Microsemi's products are covered by one or more of U.S. patents 4,895,810 5,045,903 5,089,434 5,182,234 5,019,522 5,262,336 6,503,786 5,256,583 4,748,103 5,283,202 5,231,474 5,434,095 5,528,058 and foreign patents. U.S and Foreign patents pending. All Rights Reserved.