

Features

- Input IP3: +31 dBm Min (Full Attenuation Range)
- Input IP3 is **15 -20 dB** Better than GaAs
- Linear Operation: +20 dBm Typ.
- 35 dB Dynamic Range (With 30 mA Bias Current)
- Single Control Voltage
- 50 ohm Impedance
- Linear Driver, DR65-0002, Available
- Test Boards are Available
- Tape and Reel Packaging Available
- SOW-16 Package

Description

M/A-COM's AT10-0017 is a PIN diode based voltage variable attenuator. This device is in a SOW-16, wide body plastic surface mount package. These attenuators have linear operating power and input intercept point levels 15 - 20 dB better than GaAs FET MMIC voltage variable attenuators. They are ideally suited for use where low distortion, high linear operating power and high dynamic range are required. These devices are optimized for the PCS frequency band, but exhibit excellent performance and repeatability over the entire specified frequency band. The AT10-0017 is ideally suited for wireless communications systems.

Functional Schematic

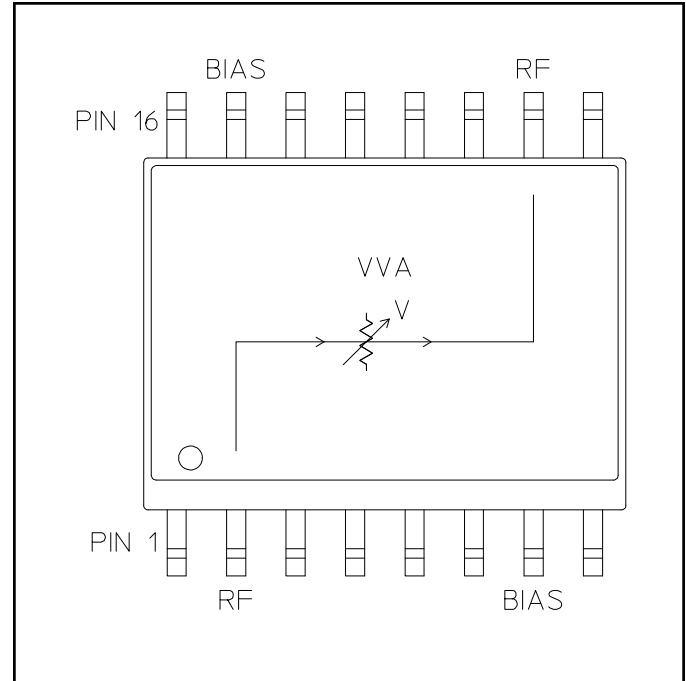

Ordering Information

Part Number	Package
AT10-0017	Tube
AT10-0017TR	1000 piece reel
AT10-0017-TB	Unit Mounted on Test Board
DR65-0002-TBP	Unit with Driver on Test Board

Note: Reference Application Note M513 for reel size information.

Pin Configuration

Pin No.	Function	Pin No.	Function
1	GND	9	GND
2	RF	10	RF
3	GND	11	GND
4	GND	12	GND
5	GND	13	GND
6	GND	14	GND
7	BIAS ¹	15	BIAS ¹
8	GND	16	GND

1. Bias currents may be applied to pin 7 or 15. The unused pins should be isolated.

Electrical Specifications: $T_A = 25^\circ\text{C}$, $Z_0 = 50\Omega$

Parameter	Test Conditions	Frequency	Units	Min	Typ	Max
Insertion Loss	0 volts	1700-2000 MHz	dB	—	—	3.5
		1930 - 1990 MHz	dB	—	2.5	3.0
Attenuation (Above Loss)	10 mA bias current	1700-2000 MHz	dB	28	—	—
		1930 - 1990 MHz	dB	30	35	—
Attenuation Flatness	0 to 30 dB attenuation	1700-2000 MHz	dB	—	1.5	2.0
		1930 - 1990 MHz	dB	—	0.4	0.6
VSWR	0 to 30 dB attenuation	1700-2000 MHz	Ratio	—	1.6:1	1.8:1
		1930 - 1990 MHz	Ratio	—	1.5:1	1.7:1
Switching Speed	50% Control to 90%/10% RF	1700-2000 MHz	μs	—	—	3.0
Linear Operation	—	1700-2000 MHz	dBm	—	+20	—
Input IP_3	Two-tone inputs up to +10 dBm	1700-2000 MHz	dBm	+31	—	—
I_{Control}	—	1700-2000 MHz	mA	—	—	30

Absolute Maximum Ratings ^{2,3}

Parameter	Absolute Maximum
Max. Input Power 1700 - 2000 MHz	+27 dBm
Operating Temperature	-40°C to +85°C
Storage Temperature	-65°C to +125°C

- Exceeding any one or combination of these limits may cause permanent damage to this device.
- M/A-COM does not recommend sustained operation near these survivability limits.

Handling Procedures

Please observe the following precautions to avoid damage:

Static Sensitivity

Gallium Arsenide Integrated Circuits are sensitive to electrostatic discharge (ESD) and can be damaged by static electricity. Proper ESD control techniques should be used when handling these devices.

Recommended PCB Configuration

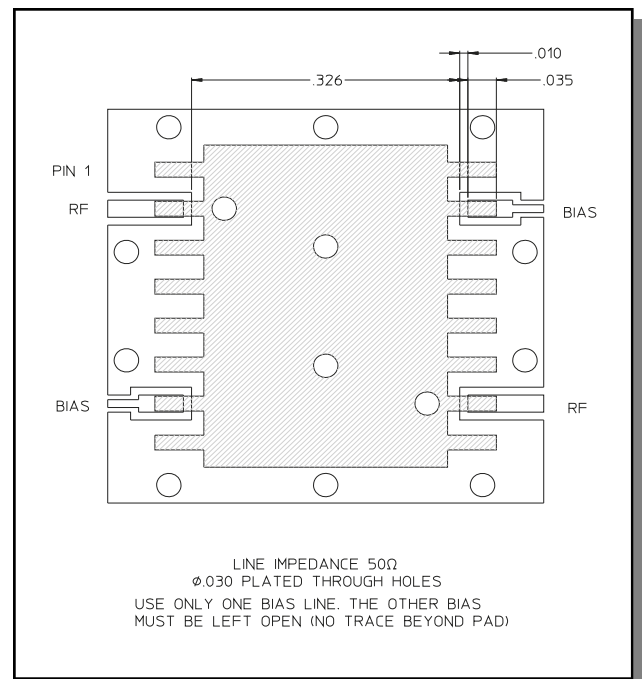

Typical Performance Curves

Insertion Loss

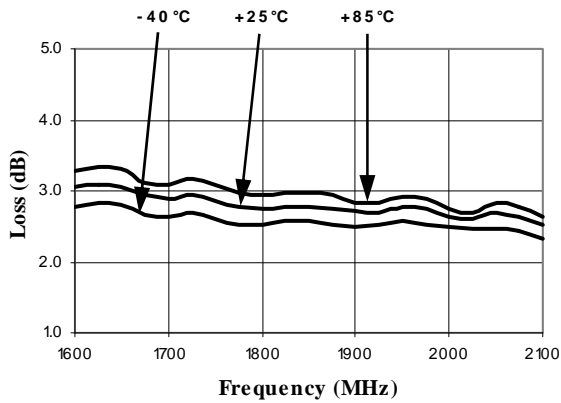

Attenuation Flatness (dB) @ +25°C

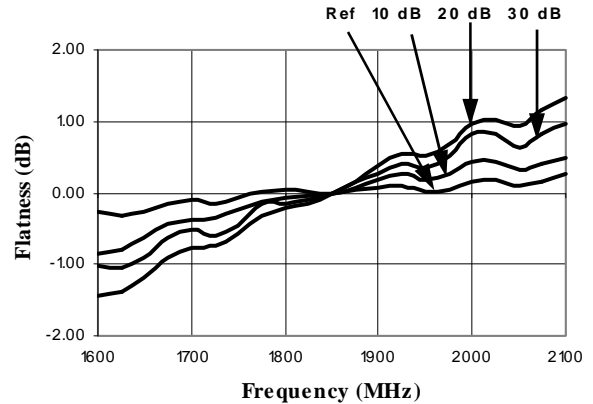

Typical VSWR @ +25°C

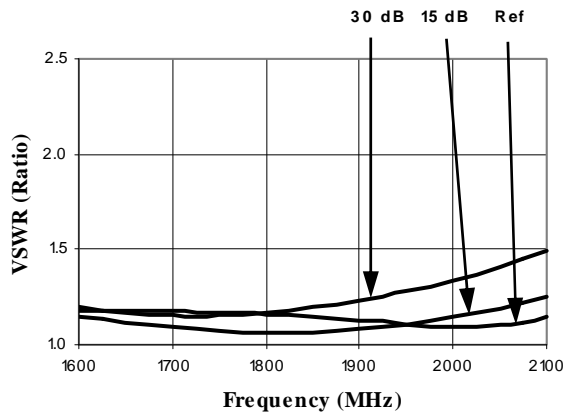

Attenuation vs. Bias Current,
Frequency = 2000 MHz

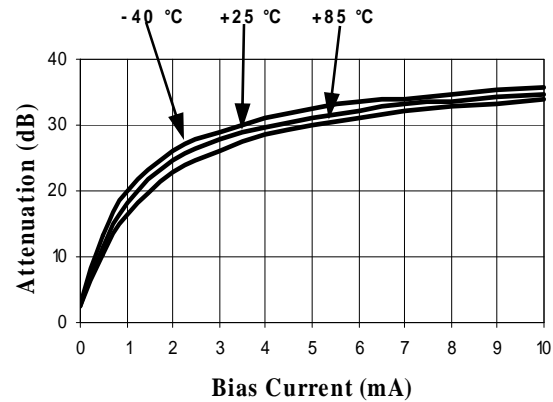

AT10-0017

Voltage Variable Absorptive
Attenuator, 1700 - 2000 MHz

Rev. V7

SOW-16[†]

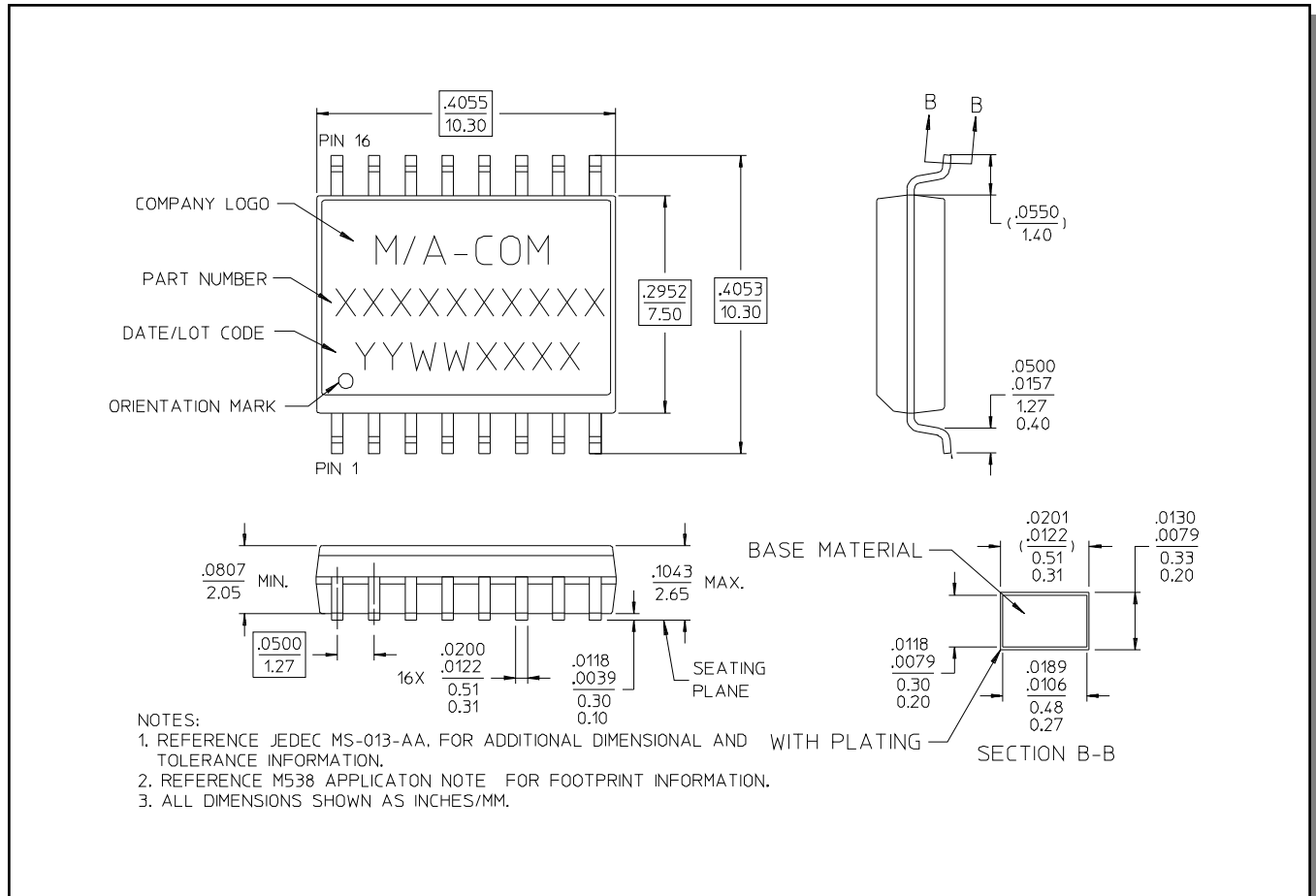

[†] Reference Application Note M538 for lead-free solder reflow recommendations.