



Relais statique biphasé de puissance Double Power Solid State Relay

SOB865660

❑ Relais statique biphasé synchrone adapté à la plupart des charges.
2 Leg Zero Cross Solid State Relay designed for most types of loads.

❑ Sortie thyristors technologie TMS² (*) permettant une longue durée de vie : **24 à 600VAC 50A**

Back to back thyristors on output with TMS² () technology for a long lifetime expectancy : 24 to 600 Vac 50A.*

❑ Entrées doubles avec LED de visualisation sur les 2 entrées de couleur verte.

Double input with green LED visualization on the inputs.

❑ Protection IP20.

IP20 protection flaps.

❑ Construit en conformité aux normes EN60947-4-3 (IEC947-4-3) et EN60950/VDE0805 (Isolement renforcé) -UL-cUL pending

Designed in conformity with EN60947-4-3 (IEC947-4-3) and EN60950/VDE0805 (Reinforced Insulation) -UL-cUL pending

❑ Différentes possibilités de connecteur de commande.

Les relais sont livrés sans le connecteur de commande. Sélectionner ce connecteur pages 6 à 9.

Different possibilities for input connector.

Input connector is not delivered with the SSR.

Select input connector in pages 6 to 9.

❑ Sur demande: Modèles asynchrone, avec protection en tension,...

On request : Random models, Voltage protection by VDR or transils

**Output : 2x50A/24-600VAC
Input : 8-30VDC**

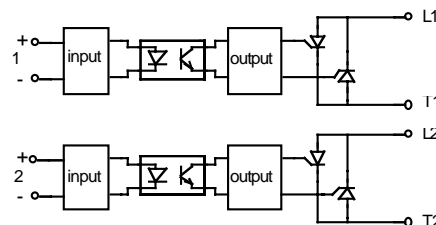
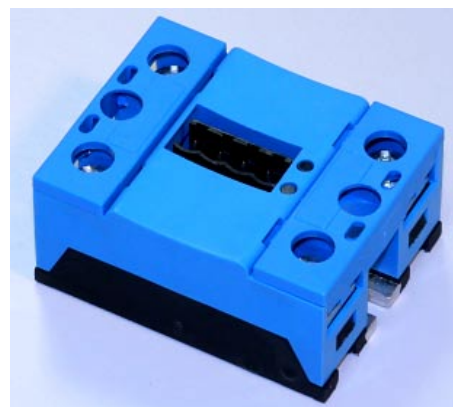

Caractéristiques d'entrée / Control characteristics (at 25°C)

Paramètre / Parameter	Symbol	DC		
		Min	Typ	Max
Tension de commande / Control voltage	Uc	8		30
Courant de commande / Control current (@ Uc)	Ic	4		24
Tension de non fonctionnement / Release voltage	Uc off	2		
LED d'entrée / Input LED		verte / green		
Tension Inverse / Reverse voltage	Urv		32	
Tension de transil d'entrée / Clamping voltage (Transil)	Uclamp		36	
Immunité / Input immunity : EN61000-4-4			2kV	
Immunité / Input immunity : EN61000-4-5			2KV	

Input : Ic = f(Uc)

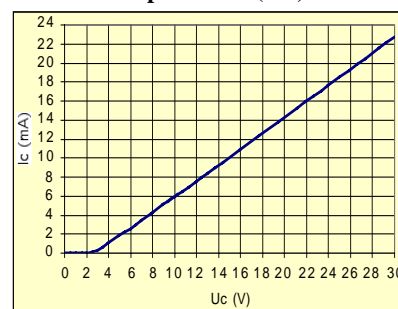

Proud to serve you

celduc®
r e l a i s

Caractéristiques de sortie / Output characteristics (at 25 °C)

Paramètre / Parameter	Conditions	Symbol	Min	Typ.	Max	Unit
Plage de tension utilisation / <i>Operating voltage range</i>		Ue	24	400	600	V rms
Tension de crête / <i>Peak voltage</i>		Up	1200			V
Niveau de synchronisme / <i>Zero cross level</i>		U _{sync}			12	V
Tension minimum amorçage / <i>Latching voltage</i>	Ie nom	Ua	10			V
Courant nominal / <i>nominal current (AC-51)</i>		Ie AC-51		50	60	A rms
Courant surcharge / <i>Non repetitive overload current</i>	tp=10ms (Fig. 3)	I _{tsm}	550	720		A
Chute directe à l'état passant / <i>On state voltage drop</i>	@ 25°C	V _t			0,9	V
Résistance dynamique / <i>On state dynamic resistance</i>		r _t			12	mΩ
Puissance dissipée (max) par phase/ <i>Output power dissipation (max value) by power</i>		P _d	0,9x0,9xIe + 0,012xIe ²			W
Résistance thermique jonction/semelle <i>Thermal resistance between junction to case</i>		R _{thj/c}			0,45	K/W
Courant de fuite à l'état bloqué / <i>Off state leakage current</i>	@Ue typ, 50Hz	I _{lk}			1	mA
Courant minimum de charge / <i>Minimum load current</i>		I _{emin}	5			mA
Temps de fermeture / <i>Turn on time</i>	@Ue typ, 50Hz	t _{on max}			10	ms
Temps d'ouverture / <i>Turn off time</i>	@Ue typ, 50Hz	t _{off max}			10	ms
Fréquence utilisation / <i>Operating frequency range</i>	F mains	f	0,1	50-60	800	Hz
dv/dt à l'état bloqué / <i>Off state dv/dt</i>		dv/dt	500			V/μs
di/dt max / <i>Maximum di/dt non repetitive</i>		di/dt			50	A/μs
I _{2t} (<10ms)		I ² _t	1500	2500		A ² s
Immunité / <i>Conducted immunity level</i>	IEC/EN61000-4-4 (bursts)		2kV criterion A			
Immunité / <i>Conducted immunity level</i>	IEC/EN61000-4-5 (surge)		2kV criterion A with external VDR			
Protection court-circuit / <i>Short circuit protection</i>	voir/see page 9	Example	Fuse FERRAZ gRC 25A/32A/50A 14x51			

Caractéristiques générales / <i>General characteristics (at 25 °C)</i>	Symbol		
Isolement entrée/sortie - <i>Input to output insulation</i>	U _i	4000	VRMS
Isolation sortie/ semelle - <i>Output to case insulation</i>	U _i	4000	VRMS
Résistance Isolement / <i>Insulation resistance</i>	R _i	1000 (@500VDC)	MΩ
Tenue aux tensions de chocs / <i>Rated impulse voltage</i>	U _{imp}	4000	V
Degré de protection / <i>Protection level / CEI529</i>		IP20	
Degré de pollution / <i>Pollution degree</i>	-	2	
Vibrations / <i>Vibration withstand 10 -55 Hz according to CEI68</i>	double amplitude	1,5	mm
Tenue aux chocs / <i>Shocks withstand according to CEI68</i>	-	30/50	g
Température de fonctionnement / <i>Ambient temperature (no icing, no condensation)</i>	-	-40 /+100	°C
Température de stockage / <i>Storage temperature (no icing, no condensation)</i>		-40/+125	°C
Humidité relative / <i>Ambient humidity</i>	HR	40 to 85	%
Poids / <i>Weight</i>		80	g
Conformité / <i>Conformity</i>		EN60947-4-3 (IEC947-4-3)	
Conformité / <i>Conformity</i>	pending	VDE0805/EN60950 UL/cUL	
plastique du boîtier / <i>Housing Material</i>		PA 6 UL94VO	
Semelle / <i>Base plate</i>		Aluminium, nickel-plated	



ISO 9001
N° 1993/1106a

celduc[®]
r e l a i s

www.celduc.com

Rue Ampère B.P. 4 42290 SORBIERS - FRANCE E-Mail : celduc-relais@celduc.com
 Fax +33 (0) 4 77 53 85 51 Service Commercial France Tél. : +33 (0) 4 77 53 90 20
 Sales Dept.For Europe Tel. : +33 (0) 4 77 53 90 21 Sales Dept. Asia : Tél. +33 (0) 4 77 53 90 19

Courbes thermiques / Thermal specifications

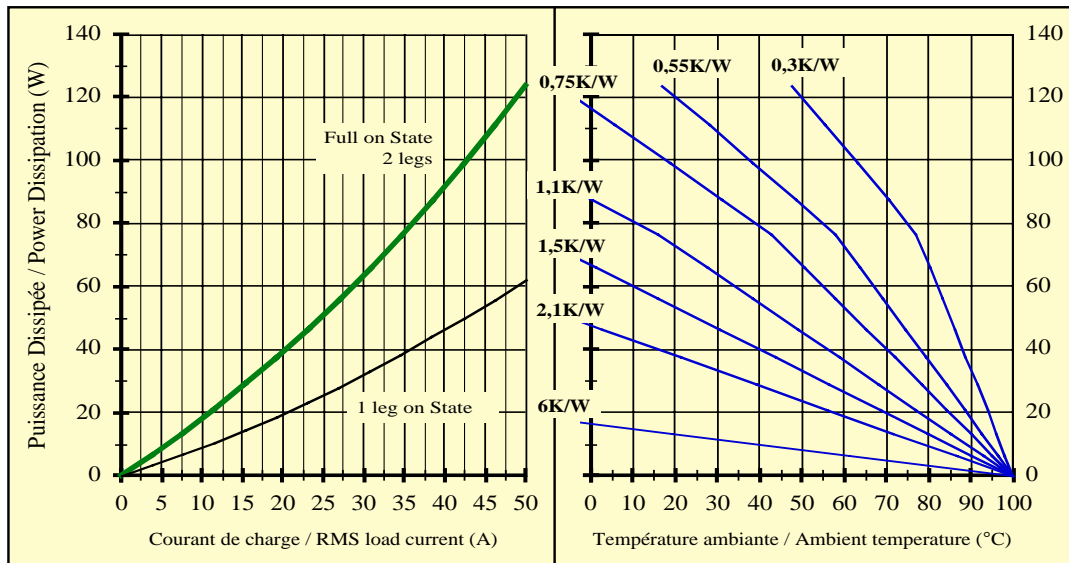

Courants de surcharges / Overload currents

1 -Itsm non répétitif sans tension réappliquée est donné pour la détermination des protections.

No repetitive Itsm is given without voltage reappplied. This curve is used to define the protection (fuses).

2 -Itsm répétitif est donné pour des surcharges de courant (T_j initiale=70°C).

Attention : la répétition de ces surcharges de courant diminue la durée de vie du relais.

Repetitive Itsm is given for inrush current with initial $T_j = 70^\circ\text{C}$. In normal operation, this curve musn't be exceeded.

Be careful, the repetition of the surge current decreases the life expectancy of the SSR.

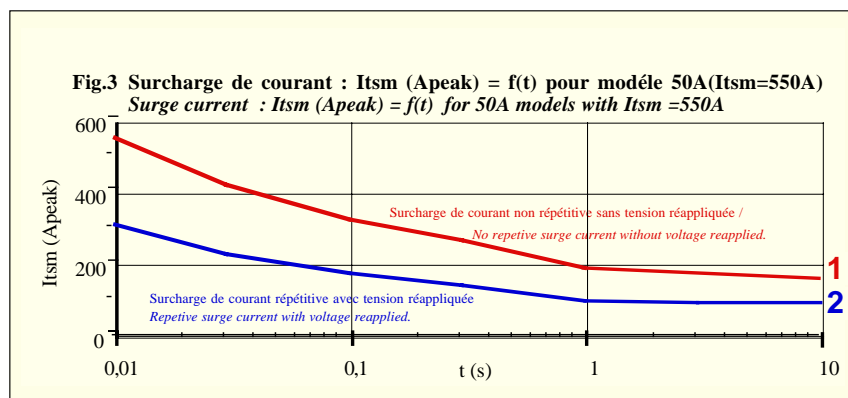

-> **Attention !** les relais à semi-conducteurs ne procurent pas d'isolation galvanique entre le réseau et la charge. Ils doivent être utilisés associés à un disjoncteur avec propriété de sectionnement ou similaire, afin d'assurer un sectionnement fiable en amont de la ligne dans l'hypothèse d'une défaillance et pour tous les cas où le relais doit être isolé du réseau (maintenance ; non utilisation sur une longue durée...).

-> **Warning !** semiconductor relays don't provide any galvanic insulation between the load and the mains. Always use in conjunction with an adapted circuit breaker with isolation feature or a similar device in order to ensure a reliable insulation in the event of wrong function and when the relay must be insulated from the mains (maintenance ; if not used for a long duration ...).

**Dimensions sans le connecteur de commande/
Dimensions without control connector**

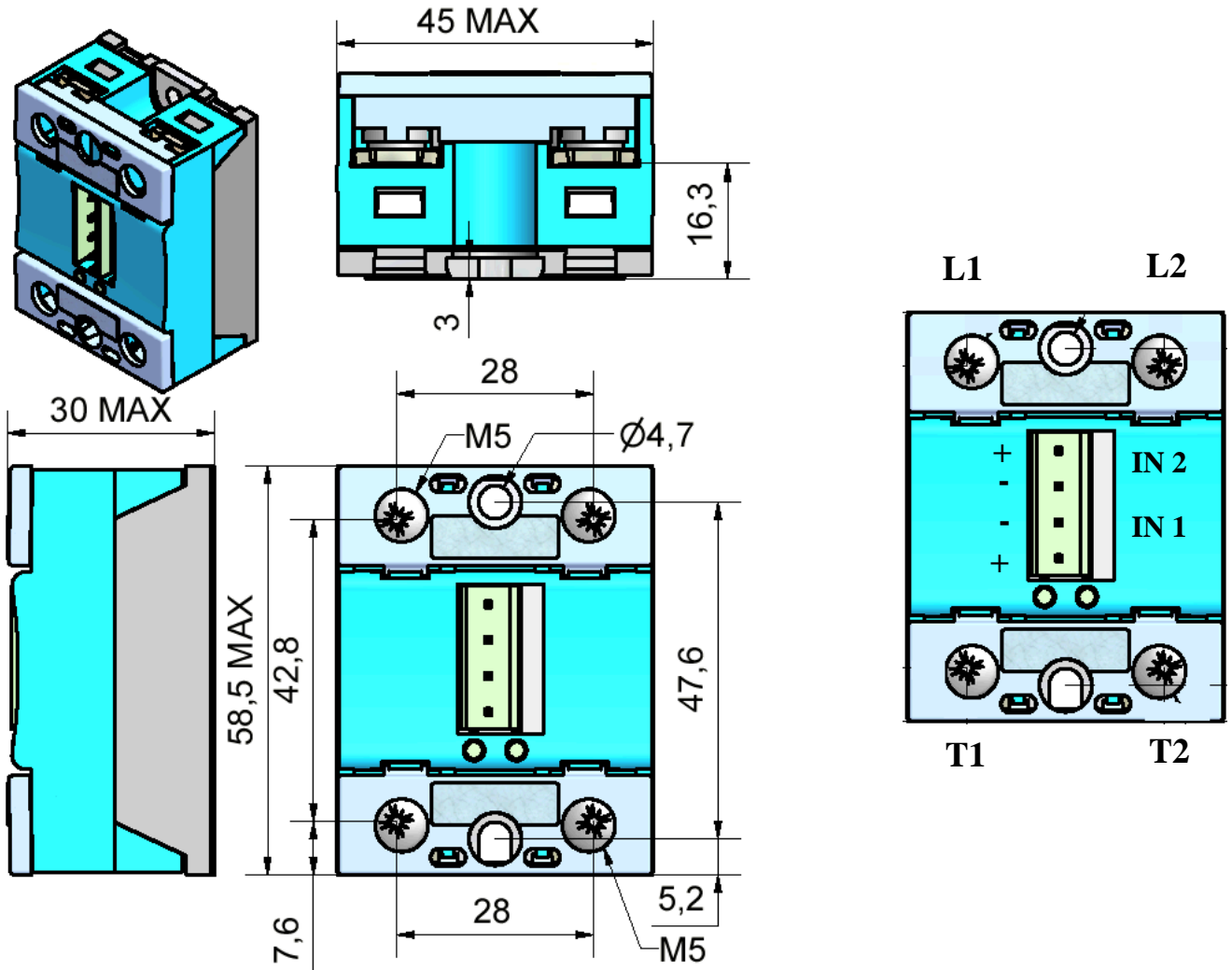

H dépend du type de connecteur de commande.

Différent modèles possibles: voir page suivantes

H max = 47mm

H depends on the type of input connector

Different solutions are available : see following pages

H max = 47mm

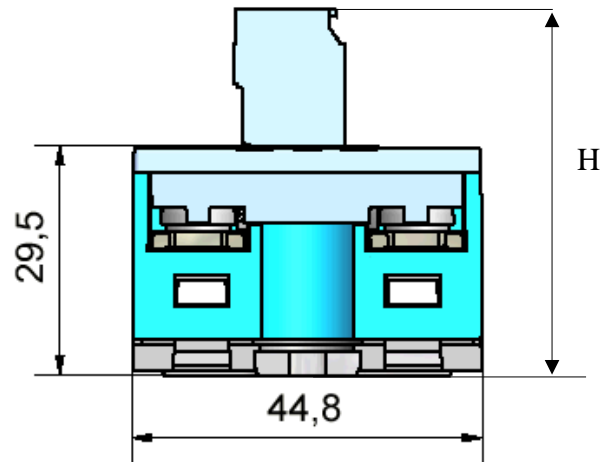

ISO 9001
N° 1993/1106a

celduc[®]
r e l a i s

www.celduc.com

Rue Ampère B.P. 4 42290 SORBIERS - FRANCE E-Mail : celduc-relais@celduc.com
 Fax +33 (0) 4 77 53 85 51 Service Commercial France Tél. : +33 (0) 4 77 53 90 20
 Sales Dept.For Europe Tel. : +33 (0) 4 77 53 90 21 Sales Dept. Asia : Tél. +33 (0) 4 77 53 90 19



Raccordement de puissance / Power connections

Directement avec fils avec ou sans embouts/
Direct connection with wires with or without ferrules

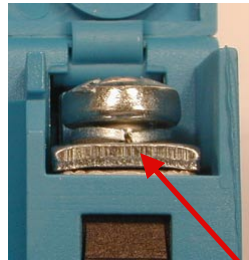
Avec cosses/
With ring terminals

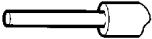
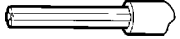
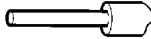

Nouvelles bornes avec rondelles freins
New terminals with washers

okpac® Raccordement de puissance / Power wiring				Modèle de tournevis / Screwdriver type	Couple de serrage recommandé Recommended Torque	
Nombre de fils / Number of wires						
1		2		 POZIDRIV 2	N.m	
Fil rigide (sans embout) SOLID (No ferrule)	Fil multibrins (avec embout) FINE STRANDED (With ferrule)	Fil rigide (sans embout) SOLID (No ferrule)	Fil multibrins (avec embout) FINE STRANDED (With ferrule)			M5
						2
1,5 ... 10 mm ² AWG16...AWG8	1,5 ... 6 mm ² AWG16...AWG10	1,5 ... 10 mm ² AWG16...AWG8	1,5 ... 6 mm ² AWG16...AWG10			

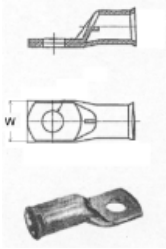
Puissance avec cosses / Power with ring terminals.
W max = 12,6mm
 16 mm² (AWG6)
 25 mm² (AWG4)
 35mm² (AWG2 /AWG3)
 50mm² (AWG0 /AWG1)

Des cosses et kits d'adaptation peuvent être fournis : voir relais forte puissance et documentation connexion forte puissance/ Suitable ring terminals and special kit for high current can be delivered: see high power SSR and data-sheet for power connexion.



Raccordement de commande par connecteur débrochable /
Control connections by pluggable connector

Différentes possibilités de connecteurs et de sortie/ Different possibilities of connectors and outputs

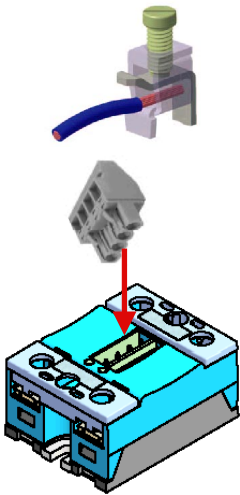
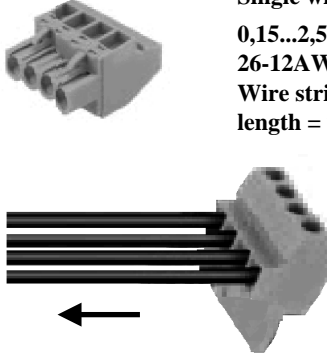
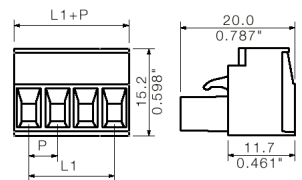
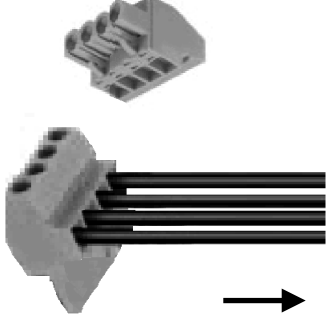
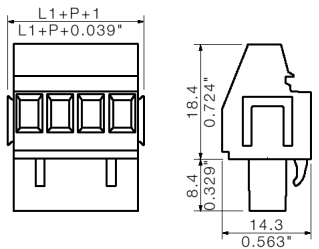
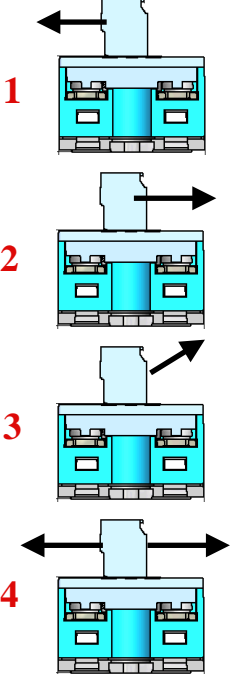
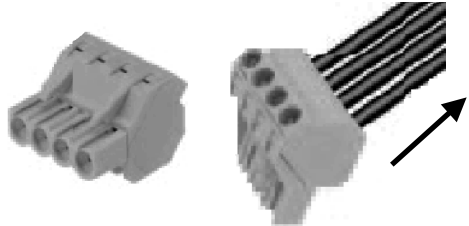
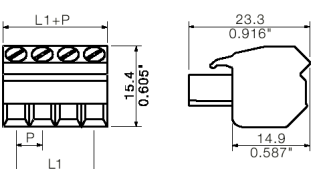
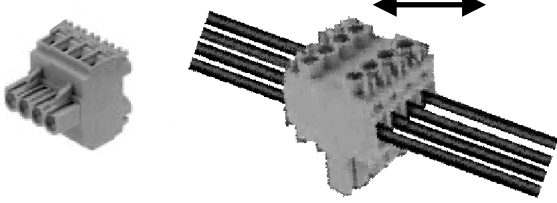
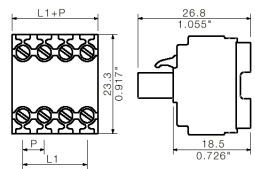
<p>Connecteur à vis Screw solution</p> 	<p>1 screw 270° Ref : 1Y042715 Weidmuller: BLZ5,08/4/270SN SW 1557510000</p>  <p>Single wire = 0,15...2,5mm² 26-12AWG Wire strip length = 7mm</p> 	<p>2 screw 90° Ref : 1Y040915 Weidmuller: BLZ5,08/4/90SN SW 1552910000</p>  <p>Single wire = 0,15...2,5mm² 26-12AWG Wire strip length = 7mm</p> 
	<p>3 Screw 45° Ref : 1Y042217 Weidmuller: BLZ5,08/4/225SN SW 1741890000</p>  <p>Single wire = 0,15...2,5mm² 26-12AWG Wire strip length = 8mm</p> 	<p>4 double Ref : 1Y041660 Weidmuller: BLDT5,08/4 SN SW 1660730000</p>  <p>Single wire = 0,15...2,5mm² 26-12AWG Wire strip length = 7mm</p> 

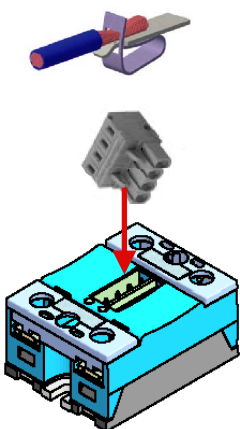
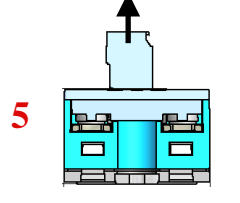
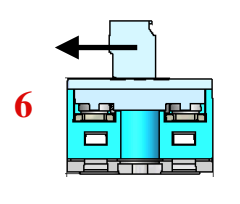
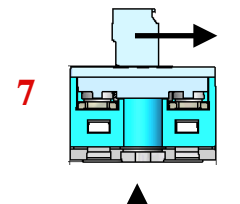
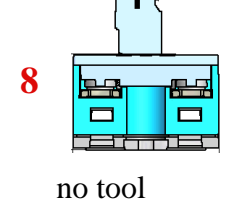
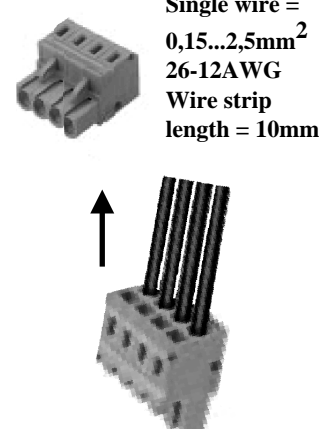
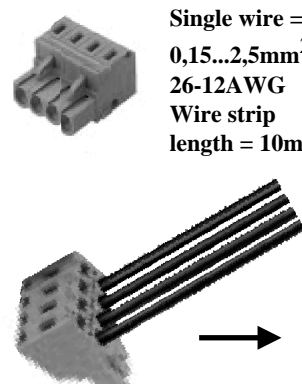
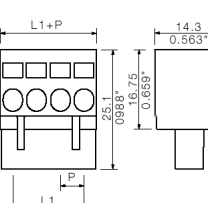
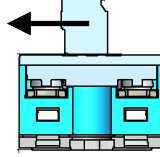
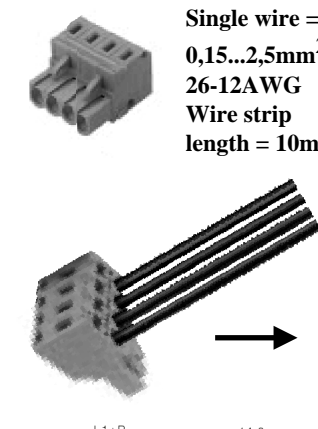
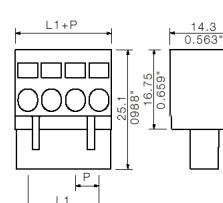
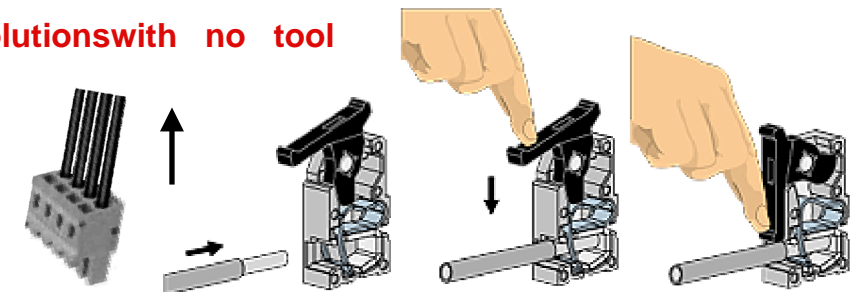
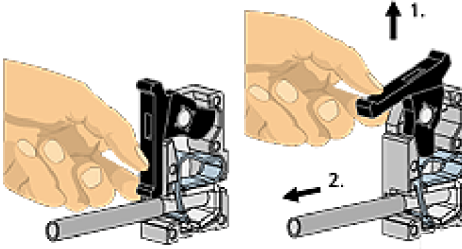
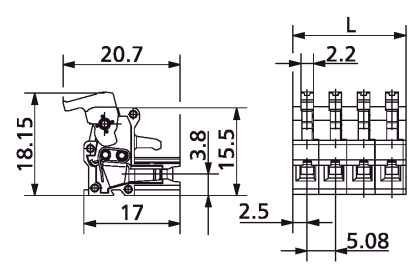

Raccordement de commande par connecteur débrochable /
Control connections by pluggable connector

Différentes possibilités de connecteurs et de sortie/ Different possibilities of connectors and outputs

<p>Solution ressort Spring solutions</p>  <p>5</p>  <p>6</p>  <p>7</p>  <p>8</p>  <p>no tool</p>	<p>5 180°</p> <p>Ref : <u>1Y041817</u> Weidmuller: BLZF5,08/4/180 SW 1707710000</p> <p>Single wire = 0,15...2,5mm² 26-12AWG Wire strip length = 10mm</p>  	<p>6 270°</p> <p>Ref : <u>1Y042716</u> Weidmuller: BLZF5,08/4/270 SW 1672190000</p> <p>Single wire = 0,15...2,5mm² 26-12AWG Wire strip length = 10mm</p>  	<p>7 90°</p> <p>Ref : <u>1Y040916</u> Weidmuller: BLZF5,08/4/90 SW 1671040000</p> <p>Single wire = 0,15...2,5mm² 26-12AWG Wire strip length = 10mm</p>  
<p>8 Spring solutions with no tool</p> <p>Ref : <u>1Y044604</u> RIA: ASO04604.02</p>  <p>Put and remove a wire</p>   <p>Wire diameter = 0,3-1,3mm 28-16 AWG</p> <p>Wire strip length = 4mm</p>			

Raccordement de commande par connecteur débrochable /
Control connections by pluggable connector

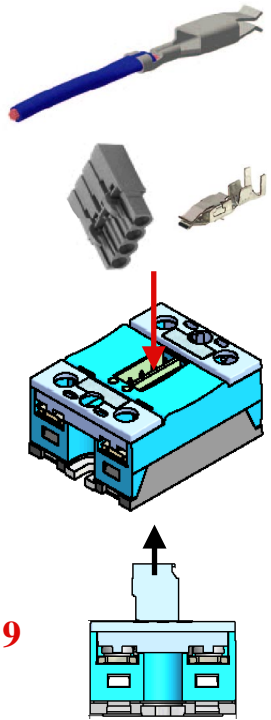
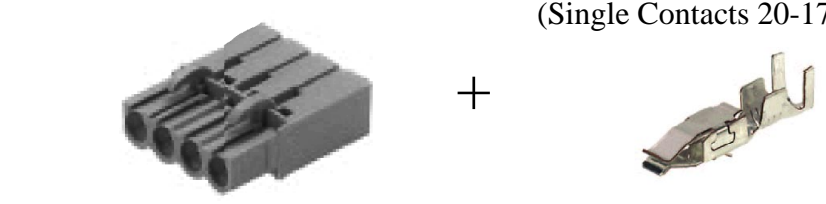
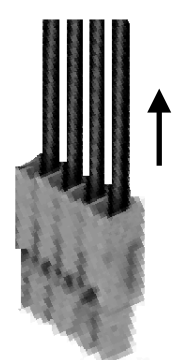
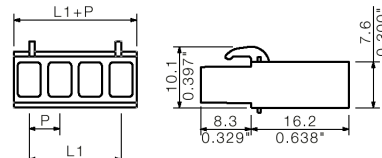
Différentes possibilités de connecteurs et de sortie/ Different possibilities of connectors and outputs

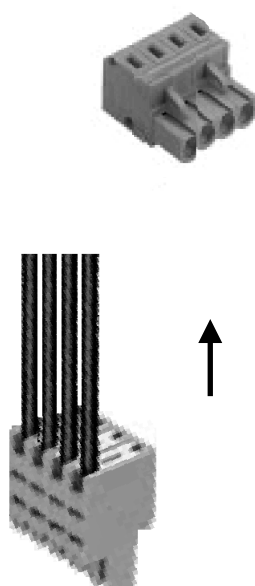
<p>Cosses Crimp solutions</p>  <p>9</p>	<p>9 Cosses / Crimp solutions</p> <p>Ref : 1Y041711 Weidmuller: BLC5,08/4/180R SW 1711980000</p> <p>Ref : 1Y011567 Weidmuller: CTS FemBLAC 0,5/1mm² 1267060000 (Single Contacts 20-17AWG)</p>  <p>+ Other sizes : 0,22 to 2,5mm² 14-24 AWG(consult us) - Stripping length = 5mm</p>   <p>Automatic process (band) : consult us</p>
<p>Insulation Displacement Connection</p>  <p>10</p>	<p>10 nous consulter / Consult us</p>  

Montage /Mounting:

- > Les relais statiques de la gamme **okpac[®]** doivent être montés sur dissipateur thermique. Une gamme étendue de dissipateurs est disponible. Voir exemples ci dessous et la gamme "WF" sur www.celduc.com.
- okpac[®]** SSRs must be mounted on heatsinks. A large range of heatsinks is available. See below some examples and "WF" range on www.celduc.com.
- > Pour le montage du relais sur dissipateur utiliser de la graisse thermique ou un "thermal pad" haute performance spécifié par **celduc[®]**. Une version autocollante précollée sur le relais est aussi disponible: nous consulter / For heatsink mounting, it is necessary to use thermal grease or thermal pad with high conductivity specified by **celduc[®]**. An adhesive model mounted by **celduc[®]** on the SSR is also available: please contact us.

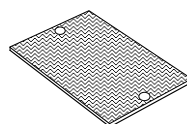
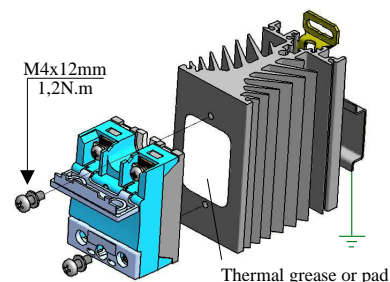

Thermal pad :
5TH21000

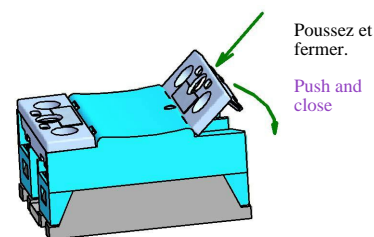

Installation des volets IP20
/ IP20 flaps mounting

Application typiques / Typical LOADS

- > Les produit SOB8 sont définis pour toute type de charge.
SOB8 product are designed for all types of loads.

Protection /Protection :

- > La protection d'un relais statique contre les court-circuits de la charge peut être faite par fusibles rapides avec des $I^2t = 1/2 I^2t$ du relais . Un test en laboratoire a été effectué sur les fusibles de marque FERRAZ. Une protection par MCB (disjoncteurs modulaires miniatures) est aussi possible. Voir notre note application (protection SSR) et utiliser des relais avec $I^2t > 5000A^2s$
- To protect the SSR against a short-circuit of the load , use a fuse with a I^2t value = 1/2 I^2t value specified page 2. A test has been made with FERRAZ fuses . It is possible to protect SSR by MCB (miniature circuit breaker). In this case, see application note (SSR protection) and use a SSR with high I^2t value (5000A²s minimum).*

EMC :

- > **Immunité :** Nous spécifions dans nos notices le niveau d'immunité de nos produits selon les normes essentielles pour ce type de produit, c'est à dire EN61000-4-4 &5.

Immunity :

We give in our data-sheets the immunity level of our SSRs according to the main standards for these products: EN61000-4-4 &5.

- > **Emission:** Nos relais statiques sont principalement conçus et conformes pour la classe d'appareils A (Industrie). L'utilisation du produit dans des environnements domestiques peut amener l'utilisateur à employer des moyens d'atténuation supplémentaires. En effet, les relais statiques sont des dispositifs complexes qui doivent être interconnectés avec d'autres matériels (charges, cables, etc) pour former un système. Etant donné que les autres matériels ou interconnexions ne sont pas de la responsabilité de **celduc[®]**, il est de la responsabilité du réalisateur du système de s'assurer que les systèmes contenant des relais statiques satisfont aux prescriptions de toutes les règles et règlements applicables au niveau des systèmes.

Consulter **celduc[®]** qui peut vous conseiller ou réaliser des essais dans son laboratoire sur votre application.

Emission: **celduc[®]** SSRs are mainly designed in compliance with standards for class A equipment (Industry).

Use of this product in domestic environments may cause radio interference. In this case the user may be required to employ additional devices to reduce noise. SSRs are complex devices that must be interconnected with other equipment (loads, cables, etc.) to form a system. Because the other equipment or the interconnections may not be under the control of **celduc[®]**, it shall be the responsibility of the system integrator to ensure that systems containing SSRs comply with the requirement of any rules and regulations applicable at the system level.

Consult **celduc[®]** for advices. Tests can be preformed in our laboratory.