

Detector Switch Compact Micro Switch Type

SSCU Series



Micro switch type for detecting very low currents.

Detector

- Push
- Slide
- Rotary
- Encoders
- Power

- Dual-in-line Package Type
- TACT Switch™
- Custom-Products

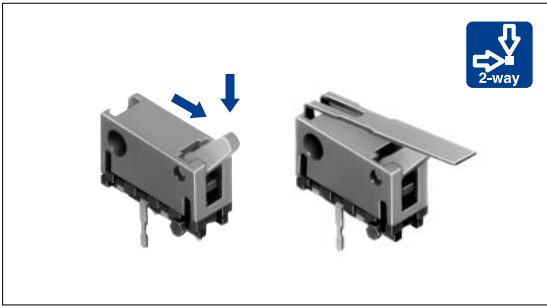

Typical Specifications

Items		Specifications
Rating (max.) (min.) (Resistive load)		0.1A 12V DC/50μA 3V DC
Contact resistance (Initial /After operating life)		70m max./100m max.
Operating force		0.5N max.
Operating life	Without load	10,000cycles
	With load	10,000cycles(0.1A 12V DC)

Product Line

Poles	Positions	Changeover timing	Operation mode	Terminal type	Minimum order unit(pcs)	Product No.	Drawing No.
1	2	Non shorting	Lever	For PC board	9,000	SSCUL10200	1
			Actuator			SSCUA10200	2

Dimensions

Unit:mm

No.	Photo	Style	PC board mounting hole dimensions (Viewed from direction A)
1			
2			

Terminal type

Unit:mm

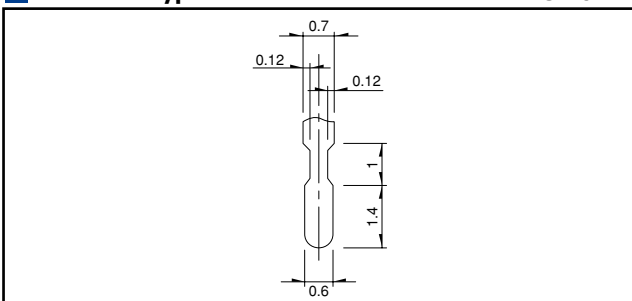



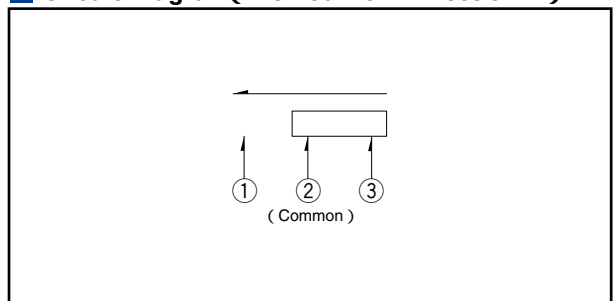













Circuit Diagram (Viewed from Direction A)



Note

Please place purchase orders per minimum order unit(integer).

List of Varieties (General-purpose Type)

Series	General-purpose Type								
	SPPB	SPVE	SPPW8	SPVM	SPVR	SPVF	SSCU	SSCT	
Photo									
Operation type	 								
Operating temperature range	-40 to +85	-10 to +60		-40 to +85		-10 to +60	-40 to +85		
Rating (max.) (Resistive load)	0.1A 30V DC			1mA 5V DC			0.1A 12V DC		
Rating (min.) (Resistive load)	50μA 3V DC		100μA 3V DC	50μA 3V DC	100μA 3V DC	50μA 3V DC			
Electrical performance	Initial contact resistance	1 max.	500m max.	1 max.	2 max.	3 max.	500m max.	70m max. 20m max.	
	Insulation resistance	100M min. 100V DC						100M min. 250V DC	
	Voltage proof	100V AC for 1 minute						250V AC for 1 minute	
Mechanical performance	Terminal strength	3N for 1 minute	0.5N for 1 minute	3N for 1 minute	1N for 1 minute	0.5N for 1 minute	3N for 30s	3N for 1 minute	
	Actuator strength	10N	5N	10N	5N	2N	1N	5N 10N	
Durability	Operating life without Load	50,000cycles 2 max.	50,000cycles 1 max.	100,000cycles 2 max.	50,000cycles 5 max.		100,000cycles 1 max.	10,000cycles 100m max. 40m max.	
	Operating life with Load	(0.1A 30V DC) 50,000cycles 2 max.	(0.1A 30V DC) 50,000cycles 1 max.	(0.1A 30V DC) 100,000cycles 2 max.	(1mA 5V DC) 50,000cycles 5 max.		(1mA 5V DC) 100,000cycles 1 max.	(0.1A 12V DC) 10,000cycles 150m max. 60m max.	
Environmental performance	Cold	-20 ± 2 for 96h					-40 ± 2 for 96h	-20 ± 2 for 96h	
	Dry heat	85 ± 2 for 96h							
	Damp heat	40 ± 2 , 90 to 95%RH for 96h							
Dimensions (mm)	W	6.3	3.4	5	2.8	3.6	9	11 12.5	
	D	3			3.5	4.2	3.5	5.8 5	
	H	4.9	2.3	4	1.5	1.2	4.5	7 11.5	
Soldering	Manual soldering	300 ± 5 , 5s max.		350 ± 5 , 3s max.			300 ± 10 , 3 ± 1s 350 ± 5 , 3s max.		
	Dip soldering	260 ± 5 , 5 ± 1s		255 ± 5 , 5 ± 1s			245 ± 5 , 5 ± 1s	260 ± 5 , 5 ± 1s	
	Reflow soldering	Please see P.79							
Number of poles	1					1.2	1		
Operation force	0.35N max.	0.3N max.		0.4N max.	0.35N max.	0.3N max.	0.5N max.	0.7 ± 0.3N	
Page	28	34	36	38	40	41	44	45	

Detector

Push

Slide

Rotary

Encoders

Power

Dual-in-line Package Type

TACT Switch™

Custom-Products

Detector Switches Soldering Conditions79

Detector Switches Cautions80