

ELM832BW CMOS Low power dual operational amplifier

■ General description

ELM832BW is low power CMOS dual operational amplifier which consists of doubly-packed ELM832B. ELM832BW makes it easy to design power circuits and is able to operate from single +1.2V source.

■ Features

- Operation from a single power source
- Low voltage operation : $1.2V \leq V_{dd} \leq 6.0V$
- Low current consumption
: $50\mu A$ (Typ. $V_{dd}=3.0V$, 2Amp. units total)
- Common-mode input voltage range
: V_{ss} to $V_{dd}-0.3V$ ($V_{dd}=1.5V$)
: V_{ss} to $V_{dd}-0.1V$ ($V_{dd}=3.0V$)
- Output stage : Push-pull
- Unity gain bandwidth : Typ. 200kHz
- Package : TSSOP-8

■ Application

- Battery-operated portable devices
- Micropower signal process
- Low voltage analog circuit

■ Maximum absolute ratings

Parameter	Symbol	Limit	Unit
Power supply voltage	V _{dd}	10	V
Input voltage	V _{in}	$V_{ss}-0.3$ to $V_{dd}+0.3$	V
Output voltage	V _{out}	$V_{ss}-0.3$ to $V_{dd}+0.3$	V
Output short circuit		Continuous	Sec.
Power dissipation	P _d	300	mW
Operating temperature	T _{op}	-20 to +70	°C
Storage temperature	T _{stg}	-55 to +125	°C

■ Selection guide

ELM832BW-x

Symbol		
a	Product version	B
b	Dual mark	W : dual
c	Taping direction	S, N : Refer to PKG file

ELM832 B W - x
 ↑ ↑ ↑
 a b c

■ Pin configuration

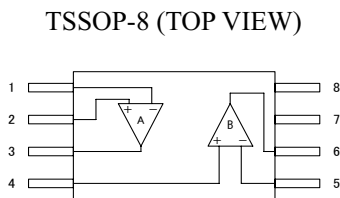

Pin No.	Pin name
1	IN-A
2	IN+A
3	OUTA
4	IN+B
5	IN-B
6	OUTB
7	VDD
8	VSS

■ Standard circuit

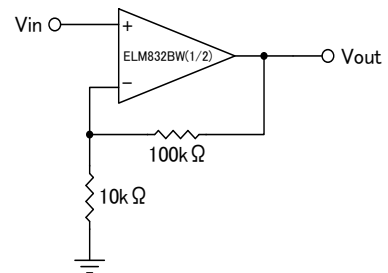

ELM832BW CMOS Low power dual operational amplifier

■Electrical characteristics (Vdd=1.5V)

V_{ss}=0V, Top=25°C

Parameter	Symbol	Condition	Min.	Typ.	Max.	Unit
Input offset voltage	V _{io}	V _{in} + = V _{dd} /2, Unity gain follower			±6	mV
Input bias current	I _{ib}				1.0	nA
Common-mode input voltage range	V _{cmr}	For CMRR ≥ 50dB	0.00		1.20	V
Maximum output voltage swing	V _{outs}	V _{id} = 100mV, R _L = 10kΩ to V _{ss}	1.40			V
Large-signal voltage gain	A _{vd}	R _L = 10kΩ to V _{ss}		95		dB
Common-mode rejection ratio	CMRR	R _L = 10kΩ to V _{ss}		70		dB
Supply voltage rejection ratio	PSRR	R _L = 10kΩ to V _{ss} V _{dd} = 1.35V to 6.0V		95		dB
Current consumption (2Amp.unit total)	I _{ss}	V _{in} + = V _{dd} /2, Unity gain follower		44	80	μA
Unity gain bandwidth	GBW			200		kHz
Slew rate	SR	R _L = 100kΩ, C _L = 20pF	80	120		mV/μs

■Electrical characteristics (Vdd=3.0V)

V_{ss}=0V, Top=25°C

Parameter	Symbol	Condition	Min.	Typ.	Max.	Unit
Input offset voltage	V _{io}	V _{in} + = V _{dd} /2, Unity gain follower			±6	mV
Input bias current	I _{ib}				1.0	nA
Common-mode input voltage range	V _{cmr}	For CMRR ≥ 50dB	0.00		2.90	V
Maximum output voltage swing	V _{outs}	V _{id} = 100mV, R _L = 10kΩ to V _{ss}	2.90			V
Large-signal voltage gain	A _{vd}	R _L = 10kΩ to V _{ss}		100		dB
Common-mode rejection ratio	CMRR	R _L = 10kΩ to V _{ss}		70		dB
Supply voltage rejection ratio	PSRR	R _L = 10kΩ to V _{ss} V _{dd} = 2.70V to 6.0V		100		dB
Current consumption (2Amp.unit total)	I _{ss}	V _{in} + = V _{dd} /2, Unity gain follower		50	90	μA
Unity gain bandwidth	GBW			150		kHz
Slew rate	SR	R _L = 100kΩ, C _L = 20pF	80	100		mV/μs

■Marking

TSSOP-8

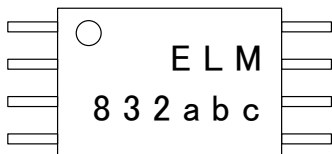

No.	Mark	Content
a	0 to 9	Last numeral of A.D.
b	A to M (excepted I)	Assembly month
c	0 to 9	Lot No.

ELM832BW CMOS Low power dual operational amplifier

■Note

1) Common mode input voltage range

ELM832BW common mode input voltage range is fixed under the condition of $CMRR \geq 50dB$; ELM832BW is able to accept the input above its specification if the degradation of $CMRR$ is not considered. Even if the input voltage exceeds either positive or negative power voltage, troubles such as reverse of output will not occur.

As maximum absolute rating, the input voltage is possible within $(V_{SS}-0.3)V$ to $(V_{DD}+0.3)V$.

2) Operation from single power source

ELM832BW is designed to be most suitable for single power source; therefore, ELM832BW is able to share power supply with logic circuit one. Meanwhile, ELM832BW can also operate from double power sources. To protect power supplies of ELM832BW and logic circuit from noise, please separate wire from power supply and use decoupling (bypass) capacitor. Using the capacitor can improve PSRR characteristics, especially on 10kHz to 100kHz or more.

3) Feedback

When OP-AMP circuit is used with feedback resistor, oscillation may happen in the circuit with loop-gain like unity gain follower.

a) When large feedback resistance is used, the phase margin is decreased by its combination with the parasitic capacitance of the input part of OP-AMP. In this situation, please connect small capacitor parallelly with feedback resistor as shown in fig-1.

b) For capacitive load, external resistor in series connection will be effective as shown in fig-2. ($R=300$ to 500Ω)

c) Being used as an unity gain follow, ELM832B is able to drive capacitive load of 100pF directly without oscillation.

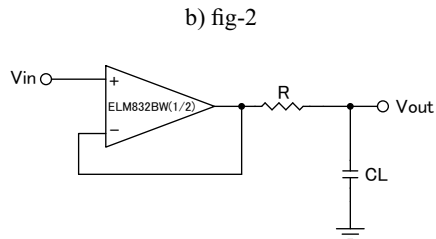
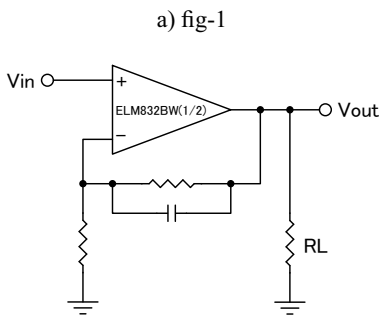

ELM832BW CMOS Low power dual operational amplifier

■ Typical characteristics

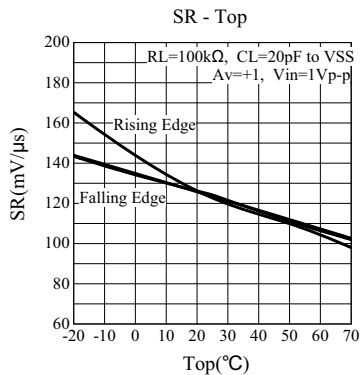
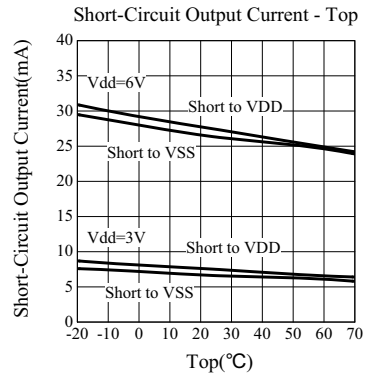
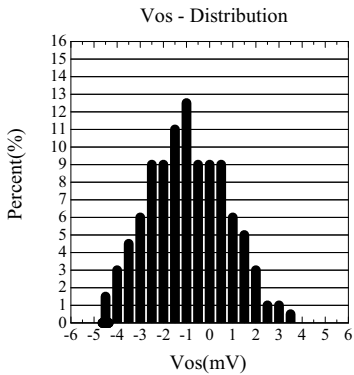
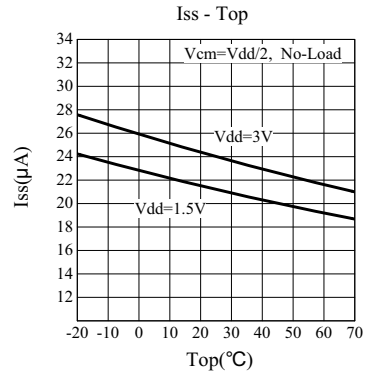
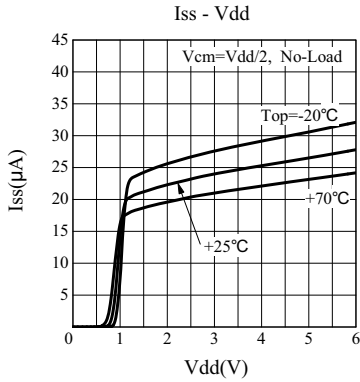

ELM832BW CMOS Low power dual operational amplifier

■ 1.5V Performance

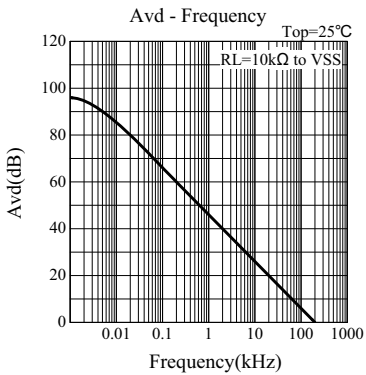
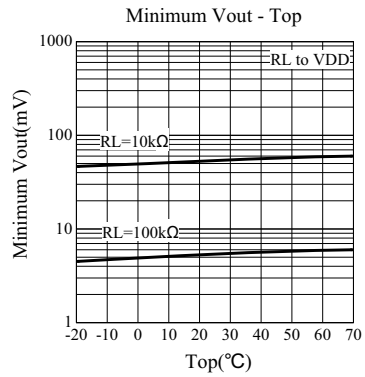
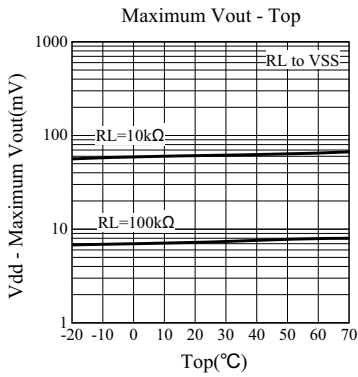
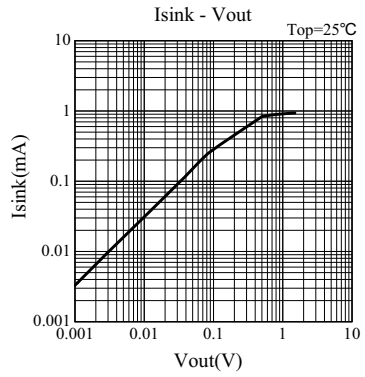
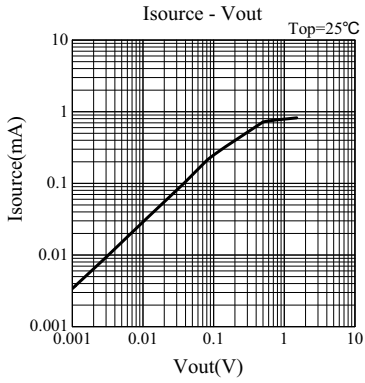

ELM832BW CMOS Low power dual operational amplifier

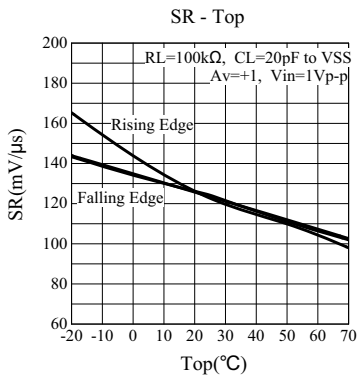
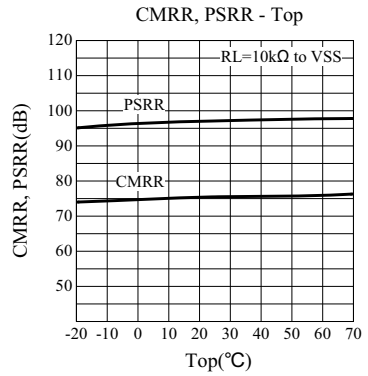
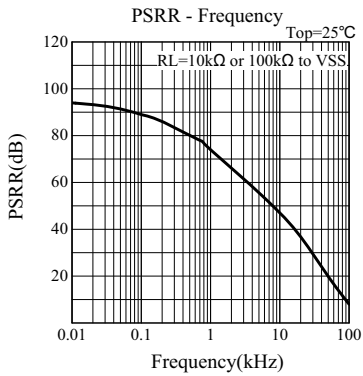
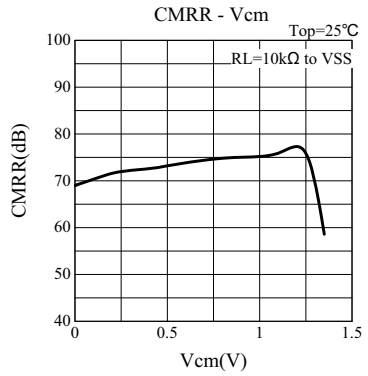
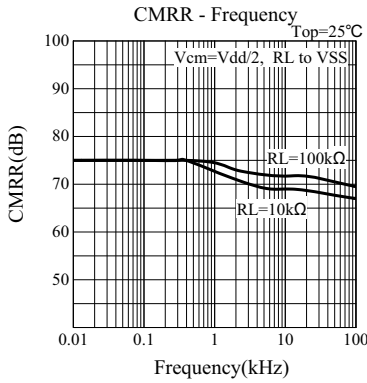

ELM832BW CMOS Low power dual operational amplifier

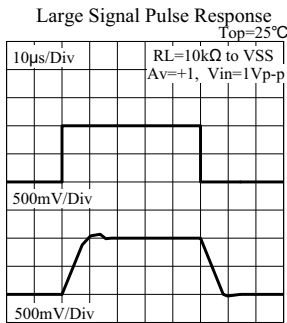
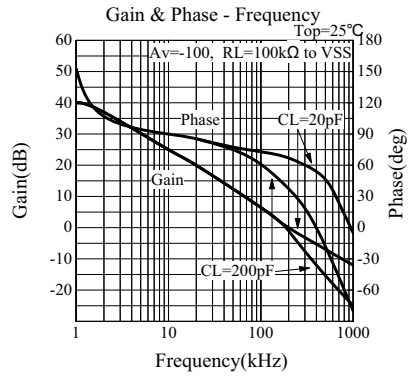
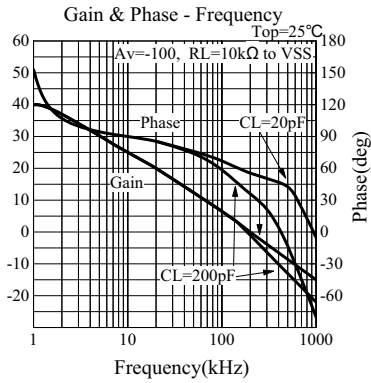

(Non-Inverting)

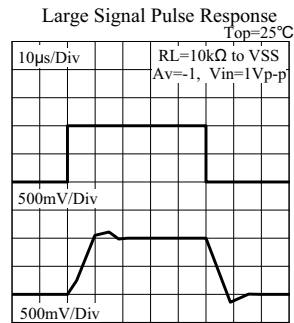

(Inverting)

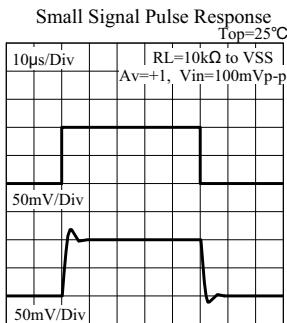

(Non-Inverting)

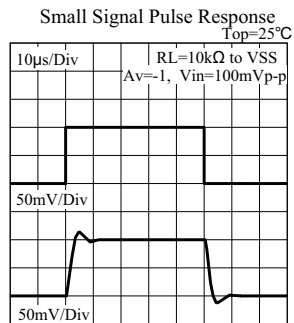

(Inverting)

ELM832BW CMOS Low power dual operational amplifier

■ 3.0V Performance

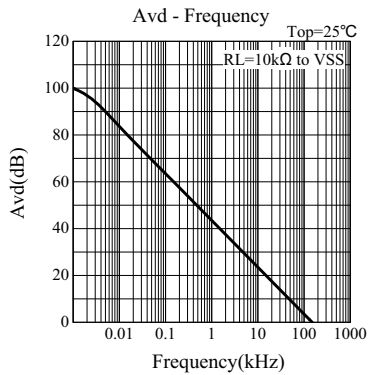
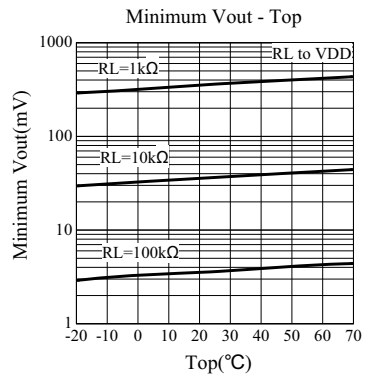
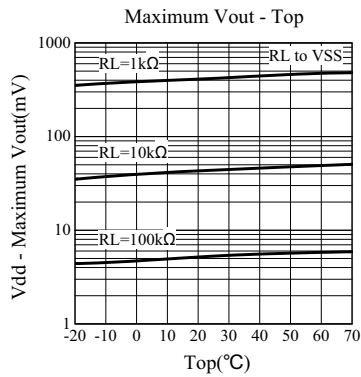
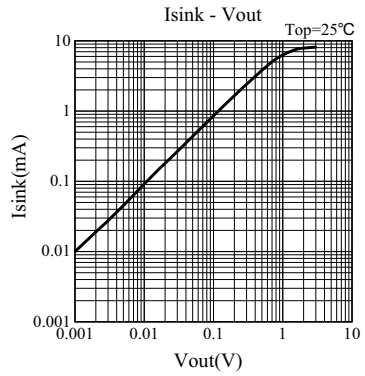
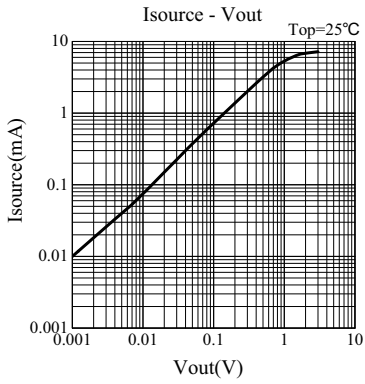

ELM832BW CMOS Low power dual operational amplifier

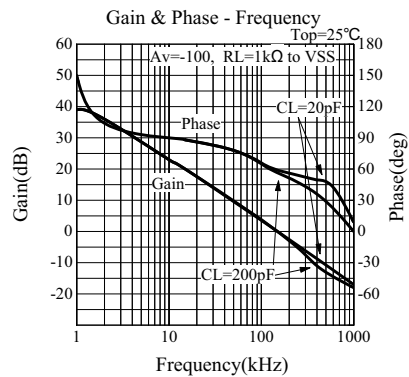
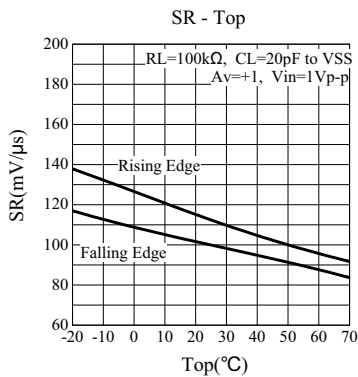
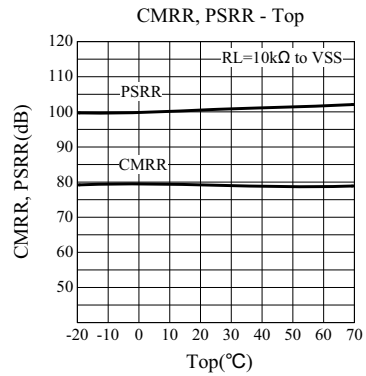
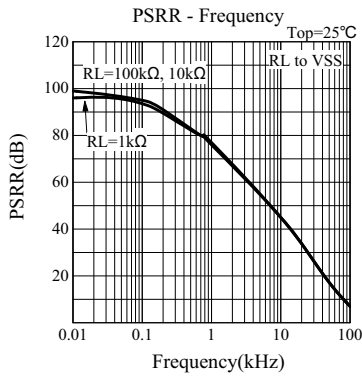
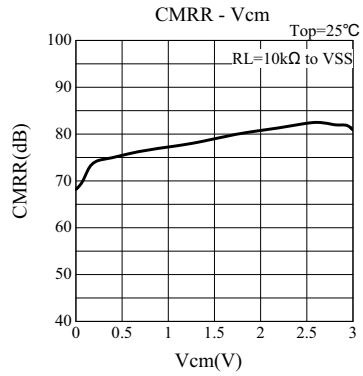
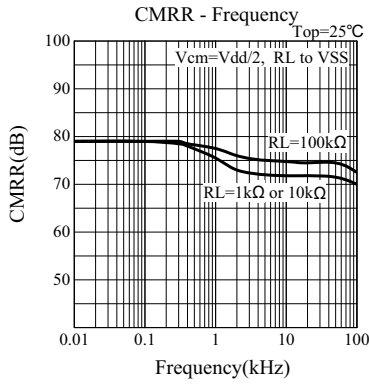

ELM832BW CMOS Low power dual operational amplifier

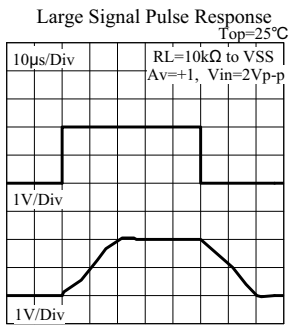
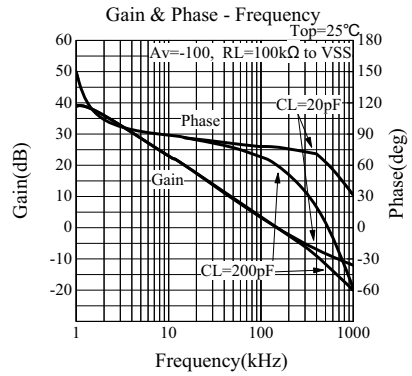
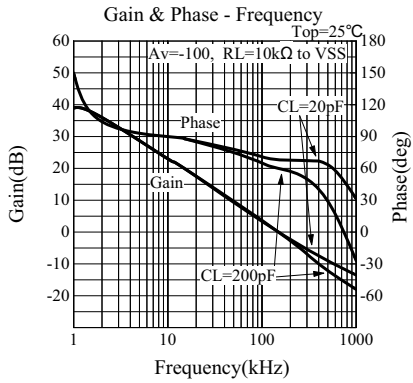

(Non-Inverting)

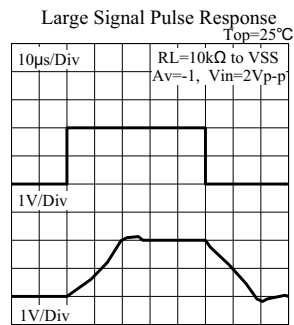

(Inverting)

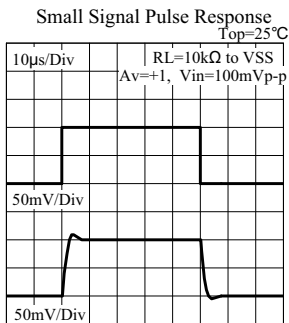

(Non-Inverting)

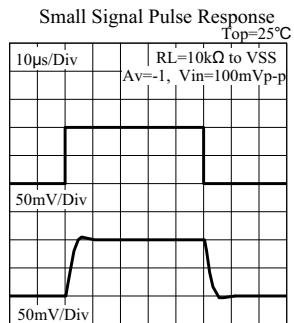

(Inverting)