

FPF1005-FPF1006 IntelliMAX™ Advanced Load Management Products

Features

- 1.2 to 5.5V Input Voltage Range
- Typical $R_{DS(ON)} = 50m\Omega$ @ $V_{IN} = 5.5V$
- Typical $R_{DS(ON)} = 55m\Omega$ @ $V_{IN} = 3.3V$
- ESD Protected, above 2000V HBM

Applications

- PDAs
- Cell Phones
- GPS Devices
- MP3 Players
- Digital Cameras
- Peripheral Ports
- Hot Swap Supplies
- RoHS Compliant

General Description

The FPF1005 & FPF1006 are low R_{DS} P-Channel MOSFET load switches with CMOS controlled turn-on targeting small package load switch applications. The input voltage range operates from 1.2V to 5.5V. Switch control is by a logic input (ON) capable of interfacing directly with low voltage control signals. In FPF1006, 120 Ω on-chip load resistor is added for output quick discharge when switch is turned off.

Both FPF1005 & FPF1006 are available in a small 2X2 MicroFET-6 pin plastic package.

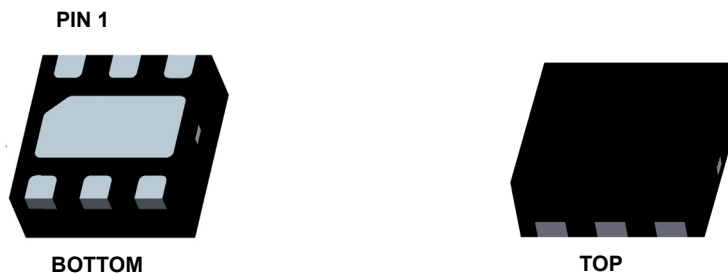

Typical Application Circuit

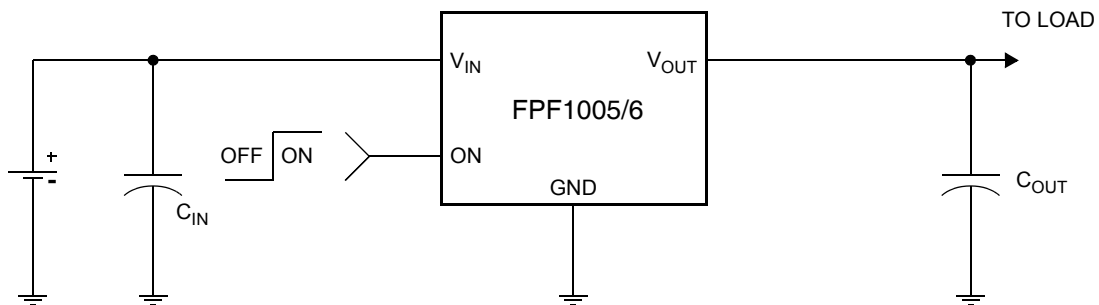

Ordering Information

Part	Switch	Input Buffer	Output Discharge	ON Pin Activity
FPF1005	55m Ω , PMOS	Schmitt	NA	Active HI
FPF1006	55m Ω , PMOS	Schmitt	120 Ω	Active HI

Functional Block Diagram

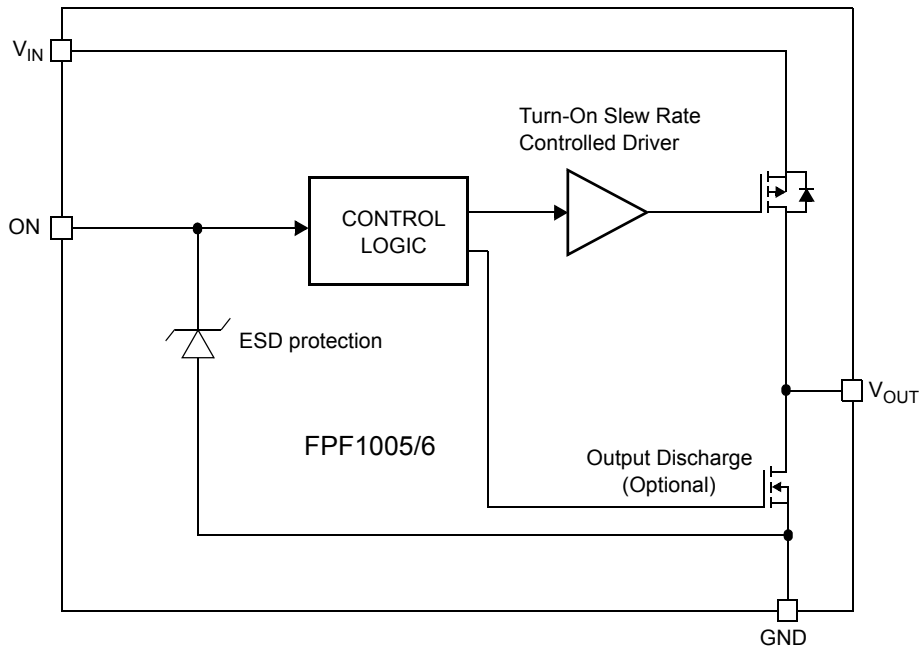

Pin Configuration

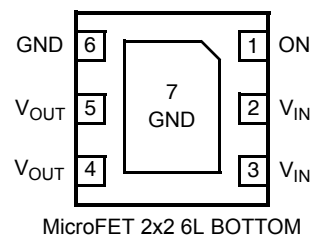

Pin Description

Pin	Name	Function
4, 5	V_{OUT}	Switch Output: Output of the power switch
2, 3	V_{IN}	Supply Input: Input to the power switch and the supply voltage for the IC
6, 7	GND	Ground
1	ON	ON/OFF Control Input

Absolute Maximum Ratings

Parameter	Min	Max	Unit
V_{IN} , V_{OUT} , ON to GND	-0.3	6	V
Maximum Continuous Switch Current		1.5	A
Power Dissipation @ $T_A = 25^\circ\text{C}$ (Note 1)		1.2	W
Operating Temperature Range	-40	85	$^\circ\text{C}$
Storage Temperature	-65	150	$^\circ\text{C}$
Thermal Resistance, Junction to Ambient		86	$^\circ\text{C}/\text{W}$
Electrostatic Discharge Protection	HBM	2000	V
	MM	200	V

Recommended Operating Range

Parameter	Min	Max	Unit
V_{IN}	1.2	5.5	V
Ambient Operating Temperature, T_A	-40	85	$^\circ\text{C}$

Electrical Characteristics

$V_{IN} = 1.2$ to 5.5V , $T_A = -40$ to $+85^\circ\text{C}$ unless otherwise noted. Typical values are at $V_{IN} = 3.3\text{V}$ and $T_A = 25^\circ\text{C}$.

Parameter	Symbol	Conditions	Min	Typ	Max	Unit
Basic Operation						
Operating Voltage	V_{IN}		1.2		5.5	V
Quiescent Current	I_Q	$I_{OUT} = 0\text{mA}$, $V_{IN} = V_{ON}$			1	μA
Off Supply Current	$I_{Q(off)}$	$V_{ON} = \text{GND}$, $\text{OUT} = \text{open}$			1	μA
Off Switch Current	$I_{SD(off)}$	$V_{ON} = \text{GND}$, $V_{OUT} = 0\text{V}$ @ $V_{IN} = 5.5\text{V}$, $T_A = 85^\circ\text{C}$			1	μA
		$V_{ON} = \text{GND}$, $V_{OUT} = 0\text{V}$ @ $V_{IN} = 3.3\text{V}$, $T_A = 25^\circ\text{C}$		10	100	nA
On-Resistance	R_{ON}	$V_{IN} = 5.5\text{V}$, $T_A = 25^\circ\text{C}$		50	70	m Ω
		$V_{IN} = 3.3\text{V}$, $T_A = 25^\circ\text{C}$		55	80	
		$V_{IN} = 1.5\text{V}$, $T_A = 25^\circ\text{C}$		95	135	
		$V_{IN} = 1.2\text{V}$, $T_A = 25^\circ\text{C}$		165	250	
Output Pull Down Resistance	R_{PD}	$V_{IN} = 3.3\text{V}$, $V_{ON} = 0\text{V}$, $T_A = 25^\circ\text{C}$, FPF1006		75	120	Ω
ON Input Logic Low Voltage	V_{IL}	$V_{IN} = 5.5\text{V}$			1.25	V
		$V_{IN} = 4.5\text{V}$			1.10	
		$V_{IN} = 1.5\text{V}$			0.50	
ON Input Logic High Voltage	V_{IH}	$V_{IN} = 5.5\text{V}$	2.00			V
		$V_{IN} = 4.5\text{V}$	1.75			
		$V_{IN} = 1.5\text{V}$	0.75			
ON Input Leakage		$V_{ON} = V_{IN}$ or GND	-1		1	μA
Dynamic						
Turn on delay	t_{ON}	$V_{IN} = 3.3\text{V}$, $R_L = 500\Omega$, $C_L = 0.1\mu\text{F}$, $T_A = 25^\circ\text{C}$		10		μs
Turn off delay	t_{OFF}	$V_{IN} = 3.3\text{V}$, $R_L = 500\Omega$, $C_L = 0.1\mu\text{F}$, $T_A = 25^\circ\text{C}$, FPF1005		50		μs
		$V_{IN} = 3.3\text{V}$, $R_L = 500\Omega$, $C_L = 0.1\mu\text{F}$, $R_{L_CHIP} = 120\Omega$, $T_A = 25^\circ\text{C}$, FPF1006		10		μs
V_{OUT} Rise Time	t_R	$V_{IN} = 3.3\text{V}$, $R_L = 500\Omega$, $C_L = 0.1\mu\text{F}$, $T_A = 25^\circ\text{C}$		10		μs
V_{OUT} Fall Time	t_F	$V_{IN} = 3.3\text{V}$, $R_L = 500\Omega$, $C_L = 0.1\mu\text{F}$, $T_A = 25^\circ\text{C}$, FPF1005		100		μs
		$V_{IN} = 3.3\text{V}$, $R_L = 500\Omega$, $C_L = 0.1\mu\text{F}$, $R_{L_CHIP} = 120\Omega$, $T_A = 25^\circ\text{C}$, FPF1006		10		μs

Note 1: Package power dissipation on 1square inch pad, 2 oz. copper board

Typical Characteristics

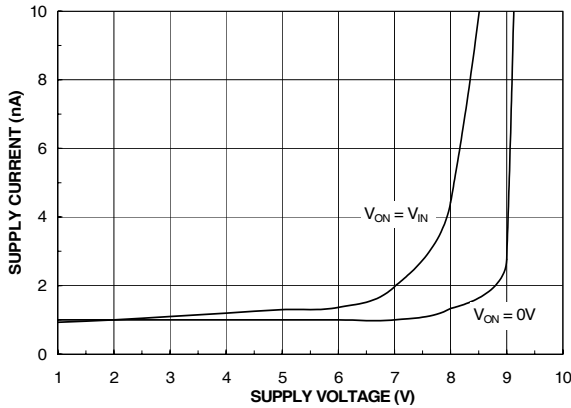

Figure 1. Quiescent Current vs. V_{IN}

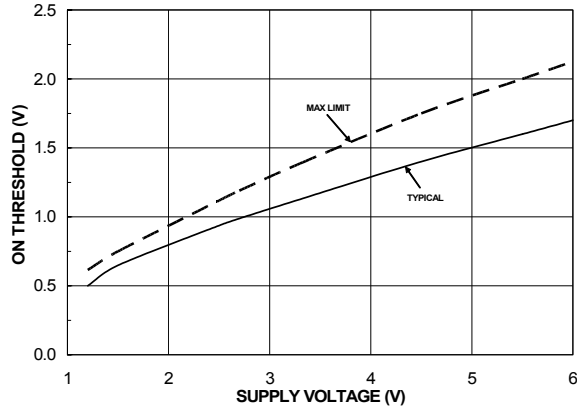

Figure 2. ON Threshold vs. V_{IN}

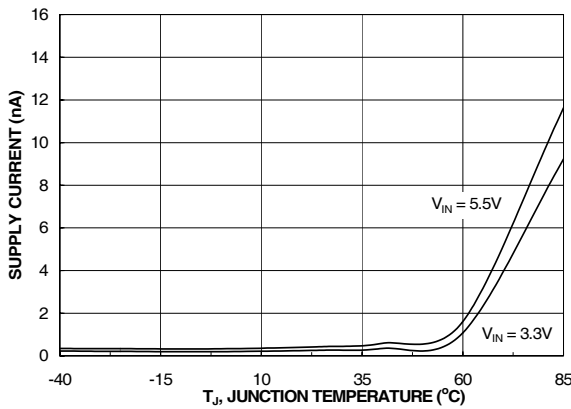

Figure 3. Quiescent Current vs. Temperature

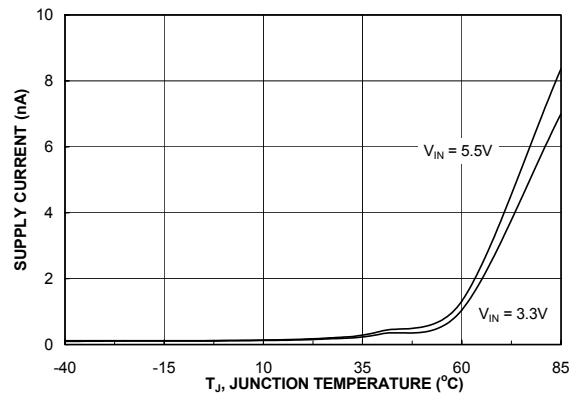

Figure 4. Quiescent Current (off) vs. Temperature

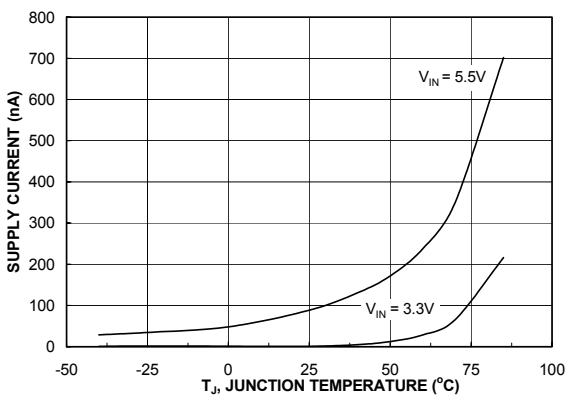

Figure 5. $I_{\text{SWITCH-OFF}}$ Current vs. Temperature

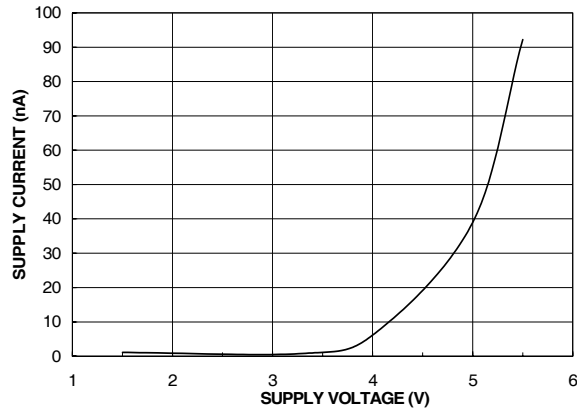

Figure 6. $I_{\text{SWITCH-OFF}}$ Current vs. V_{IN}

Typical Characteristics

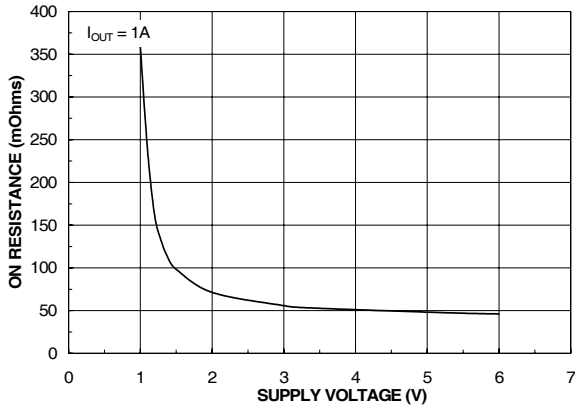

Figure 7. R_{ON} vs. V_{IN}

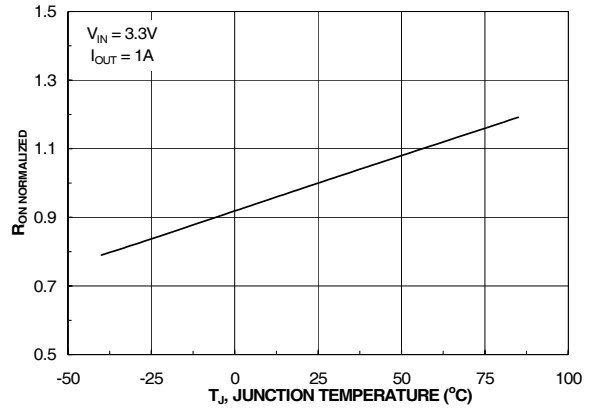

Figure 8. R_{ON} vs. Temperature

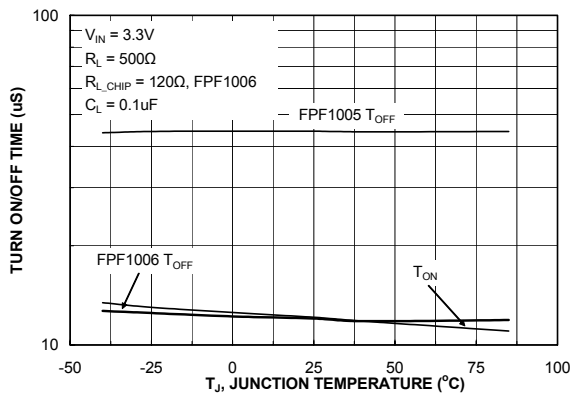

Figure 9. T_{ON}/T_{OFF} vs. Temperature

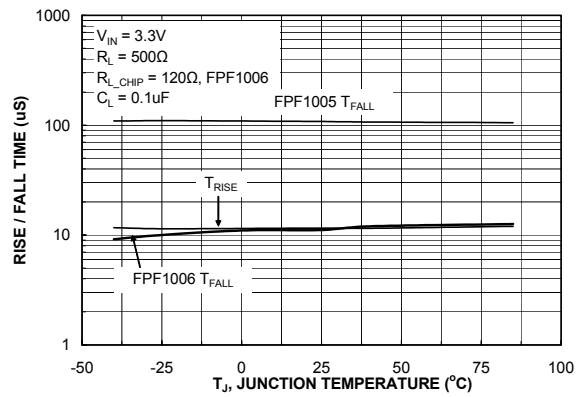

Figure 10. T_{RISE}/T_{FALL} vs. Temperature

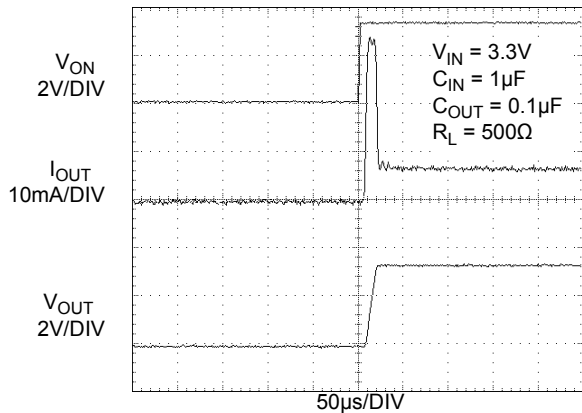

Figure 11. FPF1005 T_{ON} Response

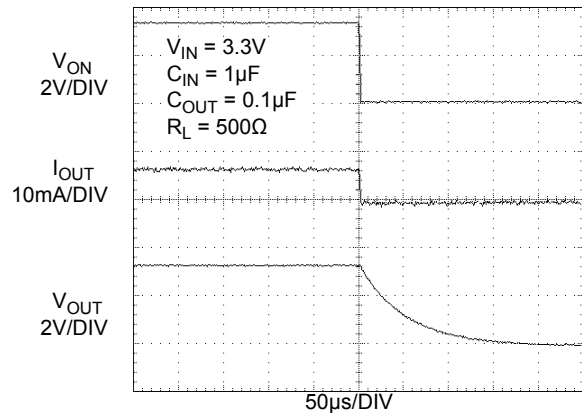

Figure 12. FPF1005 T_{OFF} Response

Typical Characteristics

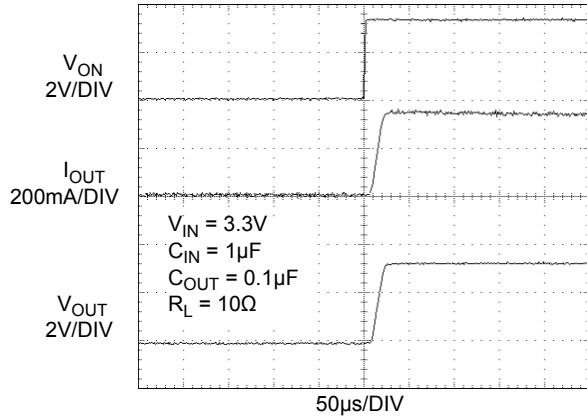

Figure 13. FPF1005 T_{ON} Response

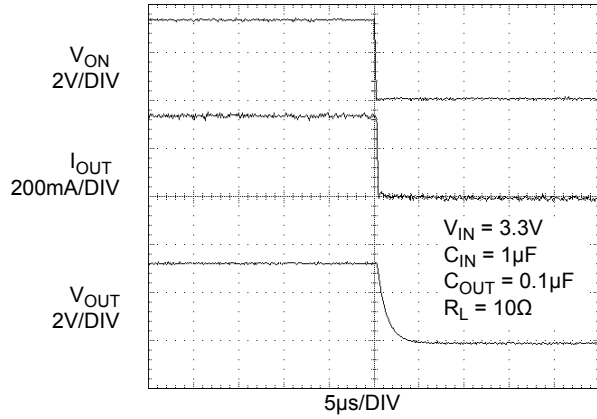

Figure 14. FPF1005 T_{OFF} Response

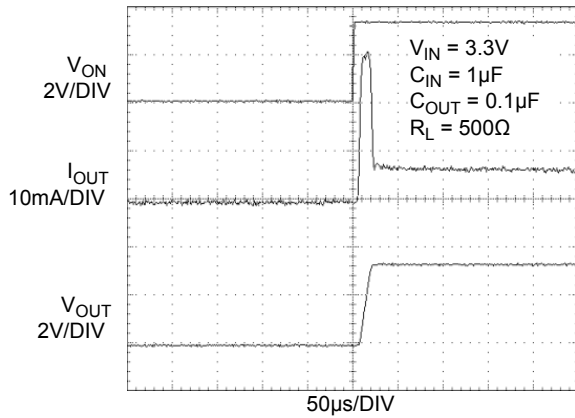

Figure 15. FPF1006 T_{ON} Response

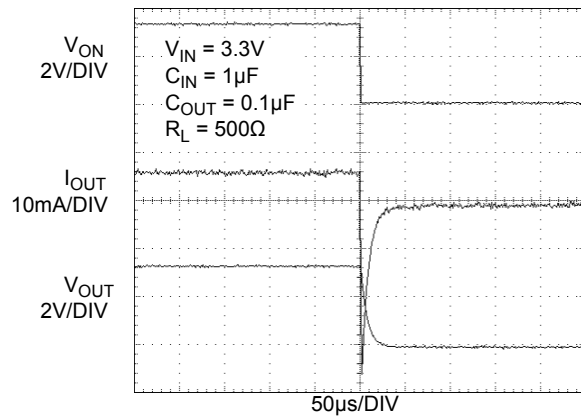

Figure 16. FPF1006 T_{OFF} Response

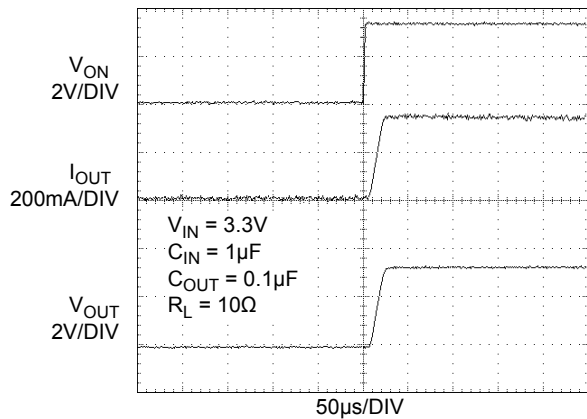

Figure 17. FPF1006 T_{ON} Response

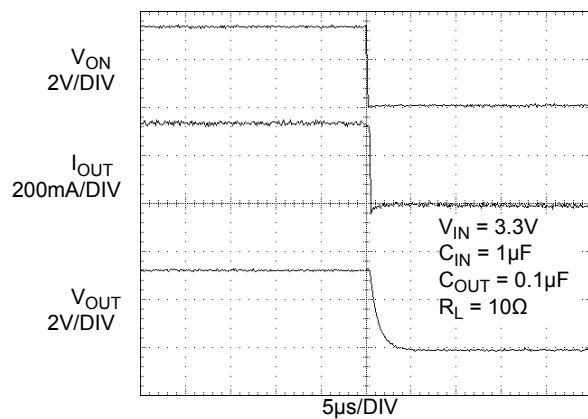

Figure 18. FPF1006 T_{OFF} Response

Description of Operation

The FPF1005 & FPF1006 are low $R_{DS(ON)}$ P-Channel load switches with controlled turn-on. The core of each device is a 55mΩ P-Channel MOSFET and a controller capable of functioning over a wide input operating range of 1.2-5.5V. The ON pin, an active HI TTL compatible input, controls the state of the switch. The FPF1006 contains a 120Ω on-chip load resistor for quick output discharge when the switch is turned off.

However, V_{OUT} pin of FPF1006 should not be connected directly to the battery source due to the discharge mechanism of the load switch.

Application Information

Typical Application

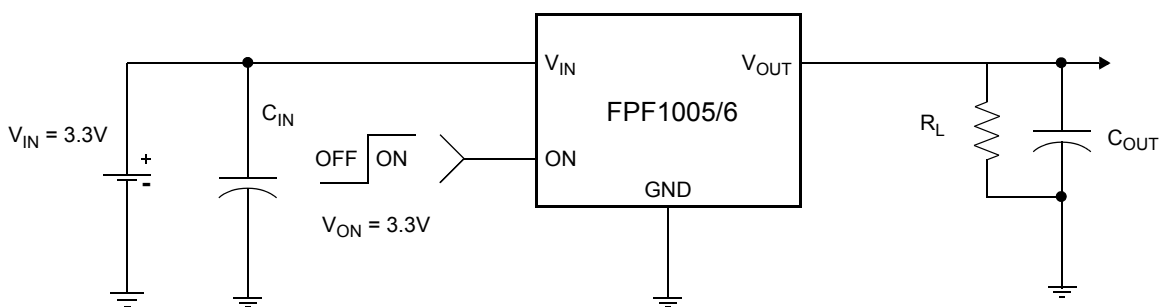

Input Capacitor

To limit the voltage drop on the input supply caused by transient in-rush currents when the switch turns-on into a discharged load capacitor or short-circuit, a capacitor needs to be placed between V_{IN} and GND. A 1μF ceramic capacitor, C_{IN} , placed close to the pins is usually sufficient. Higher values of C_{IN} can be used to further reduce the voltage drop during higher current application.

Output Capacitor

A 0.1μF capacitor, C_{OUT} , should be placed between V_{OUT} and GND. This capacitor will prevent parasitic board inductance from forcing V_{OUT} below GND when the switch turns-off. Due to the integral body diode in the PMOS switch, a C_{IN} greater than C_{OUT} is highly recommended. A C_{OUT} greater than C_{IN} can cause V_{OUT} to exceed V_{IN} when the system supply is removed. This could result in current flow through the body diode from V_{OUT} to V_{IN} .

Board Layout

For best performance, all traces should be as short as possible. To be most effective, the input and output capacitors should be placed close to the device to minimize the effects that parasitic trace inductances may have on normal and short-circuit operation. Using wide traces or large copper planes for all pins (V_{IN} , V_{OUT} , ON and GND) will help minimize the parasitic electrical effects along with minimizing the case to ambient thermal impedance.

Evaluation Board Layout

FPF1005/6 Demo board has the components and circuitry to demonstrate the load switch functions. Thermal performance of the load switch can be improved significantly by connecting the middle pad (pin 7) to the GND area of the PCB.

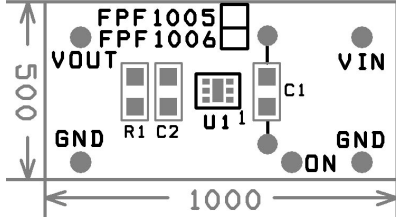

Figure 19. Demo board silk screen top and component assembly drawing.

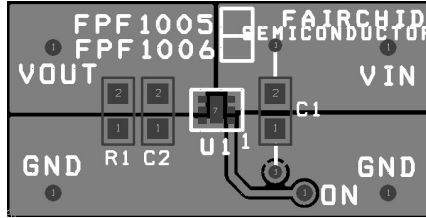

Figure 20. Demo board top and surface mount top layers view. (Pin 7 is connected to GND).

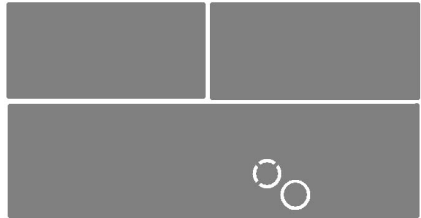
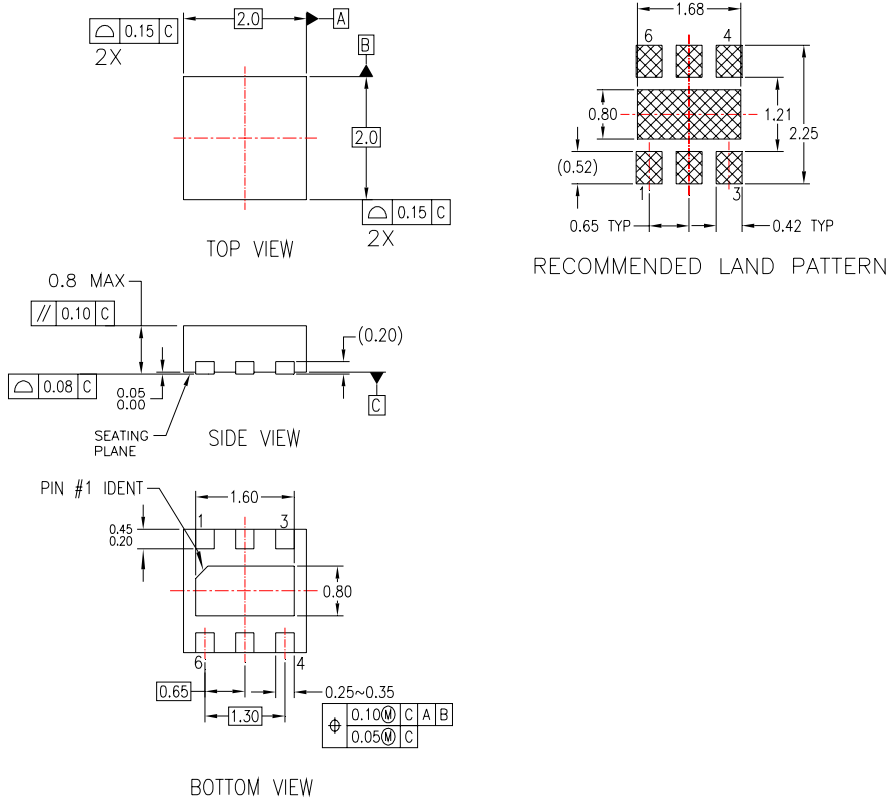

Figure 21. Demo board bottom layer view.

Dimensional Outline and Pad Layout



NOTES:

- A. NON-CONFORMS TO JEDEC REGISTRATION.
- B. DIMENSIONS ARE IN MILLIMETERS.
- C. DIMENSIONS AND TOLERANCES PER ASME Y14.5M, 1994



TRADEMARKS

The following are registered and unregistered trademarks and service marks Fairchild Semiconductor owns or is authorized to use and is not intended to be an exhaustive list of all such trademarks.

- | | | | |
|--------------------------|---|----------------------------|----------------------|
| ACEx® | Green FPS™ | Power247® | SuperSOT™-8 |
| Build it Now™ | Green FPS™ e-Series™ | POWEREDGE® | SyncFET™ |
| CorePLUS™ | GTO™ | Power-SPM™ | The Power Franchise® |
| CROSSVOLT™ | i-Lo™ | PowerTrench® | the power® |
| CTL™ | IntelliMAX™ | Programmable Active Droop™ | franchise |
| Current Transfer Logic™ | ISOPLANAR™ | QFET® | TinyBoost™ |
| EcoSPARK® | MegaBuck™ | QS™ | TinyBuck™ |
| F ® | MICROCOUPLER™ | QT Optoelectronics™ | TinyLogic® |
| Fairchild® | MicroFET™ | Quiet Series™ | TINYOPTO™ |
| Fairchild Semiconductor® | MicroPak™ | RapidConfigure™ | TinyPower™ |
| FACT Quiet Series™ | MillerDrive™ | SMART START™ | TinyPWM™ |
| FACT® | Motion-SPM™ | SPM® | TinyWire™ |
| FAST® | OPTOLOGIC® | STEALTH™ | µSerDes™ |
| FastvCore™ | OPTOPLANAR® | SuperFET™ | UHC® |
| FPS™ |  ® | SuperSOT™-3 | UniFET™ |
| FRFET® | PDP-SPM™ | SuperSOT™-6 | VCX™ |
| Global Power ResourceSM | Power220® | | |

DISCLAIMER

FAIRCHILD SEMICONDUCTOR RESERVES THE RIGHT TO MAKE CHANGES WITHOUT FURTHER NOTICE TO ANY PRODUCTS HEREIN TO IMPROVE RELIABILITY, FUNCTION, OR DESIGN. FAIRCHILD DOES NOT ASSUME ANY LIABILITY ARISING OUT OF THE APPLICATION OR USE OF ANY PRODUCT OR CIRCUIT DESCRIBED HEREIN; NEITHER DOES IT CONVEY ANY LICENSE UNDER ITS PATENT RIGHTS, NOR THE RIGHTS OF OTHERS. THESE SPECIFICATIONS DO NOT EXPAND THE TERMS OF FAIRCHILD'S WORLDWIDE TERMS AND CONDITIONS, SPECIFICALLY THE WARRANTY THEREIN, WHICH COVERS THESE PRODUCTS.

LIFE SUPPORT POLICY

FAIRCHILD'S PRODUCTS ARE NOT AUTHORIZED FOR USE AS CRITICAL COMPONENTS IN LIFE SUPPORT DEVICES OR SYSTEMS WITHOUT THE EXPRESS WRITTEN APPROVAL OF FAIRCHILD SEMICONDUCTOR CORPORATION.

As used herein:

- Life support devices or systems are devices or systems which, (a) are intended for surgical implant into the body, or (b) support or sustain life, and (c) whose failure to perform when properly used in accordance with instructions for use provided in the labeling, can be reasonably expected to result in significant injury to the user.
- A critical component is any component of a life support device or system whose failure to perform can be reasonably expected to cause the failure of the life support device or system, or to affect its safety or effectiveness.

PRODUCT STATUS DEFINITIONS

Definition of Terms

Datasheet Identification	Product Status	Definition
Advance Information	Formative or In Design	This datasheet contains the design specifications for product development. Specifications may change in any manner without notice.
Preliminary	First Production	This datasheet contains preliminary data; supplementary data will be published at a later date. Fairchild Semiconductor reserves the right to make changes at any time without notice to improve design.
No Identification Needed	Full Production	This datasheet contains final specifications. Fairchild Semiconductor reserves the right to make changes at any time without notice to improve design.
Obsolete	Not In Production	This datasheet contains specifications on a product that has been discontinued by Fairchild semiconductor. The datasheet is printed for reference information only.