

General Purpose NPN Epitaxial Planar Transistors (dual transistors)

HBN2222S6R

Features

- Two BTN2222A chips in a SOT-363R package.
- Mounting possible with SOT-323 automatic mounting machines.
- Transistor elements are independent, eliminating interference.
- Mounting cost and area can be cut in half.

Equivalent Circuit

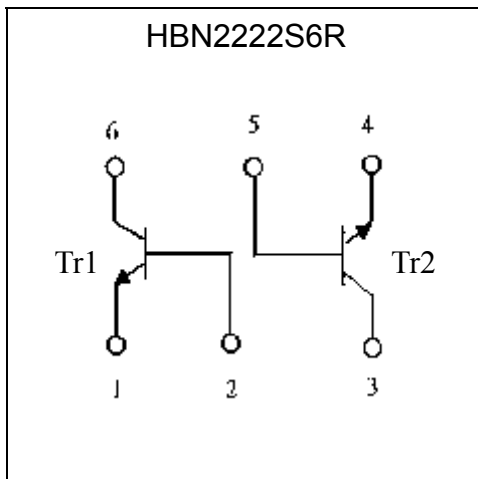

Outline

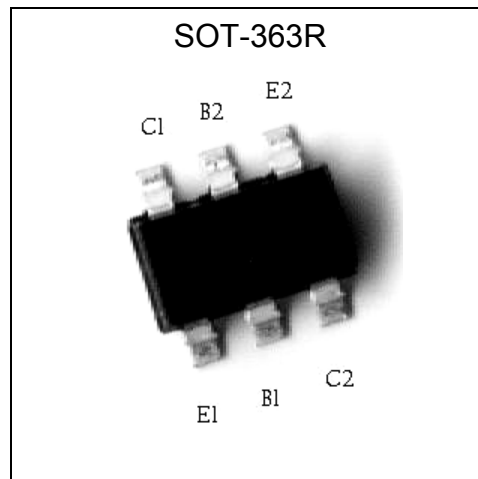

The following characteristics apply to both Tr1 and Tr2

Absolute Maximum Ratings (Ta=25°C)

Parameter	Symbol	Limits	Unit
Collector-Base Voltage	V _{CBO}	75	V
Collector-Emitter Voltage	V _{CEO}	40	V
Emitter-Base Voltage	V _{EBO}	6	V
Collector Current	I _C	600	mA
Power Dissipation	P _d	300(total) *1	mW
Junction Temperature	T _j	150	°C
Storage Temperature	T _{stg}	-55~+150	°C

Note : *1 200mW per element must not be exceeded

**Characteristics (Ta=25°C)**

Symbol	Min.	Typ.	Max.	Unit	Test Conditions
BV _{CBO}	75	-	-	V	I _C =10μA
BV _{CEO}	40	-	-	V	I _C =10mA
BV _{EBO}	6	-	-	V	I _E =10μA
I _{CBO}	-	-	10	nA	V _{CB} =60V
I _{CEX}	-	-	10	nA	V _{CB} =60V, V _{EB(off)} = 3V
I _{EBO}	-	-	100	nA	V _{EB} =3V
*V _{CE(sat)} 1	-	-	0.3	V	I _C =150mA, I _B =15mA
*V _{CE(sat)} 2	-	-	1.0	V	I _C =500mA, I _B =50mA
*V _{BE(sat)} 1	-	-	1.2	V	I _C =150mA, I _B =15mA
*V _{BE(sat)} 2	-	-	2.0	V	I _C =500mA, I _B =50mA
*h _{FE} 1	35	-	-	-	V _{CE} =10V, I _C =100μA
*h _{FE} 2	50	-	-	-	V _{CE} =10V, I _C =1mA
*h _{FE} 3	75	-	-	-	V _{CE} =10V, I _C =10mA
*h _{FE} 4	100	-	300	-	V _{CE} =10V, I _C =150mA
*h _{FE} 5	50	-	-	-	V _{CE} =1V, I _C =150mA
*h _{FE} 6	40	-	-	-	V _{CE} =10V, I _C =500mA
f _T	300	-	-	MHz	V _{CE} =20V, I _C =20mA, f=100MHz
C _{ob}	-	-	8	pF	V _{CB} =10V, f=1MHz

*Pulse Test: Pulse Width ≤380μs, Duty Cycle≤2%

Characteristic Curves

Current Gain vs Collector Current

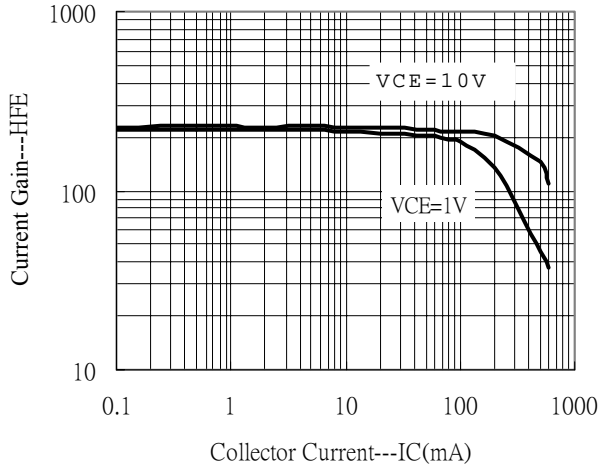

Saturation Voltage vs Collector Current

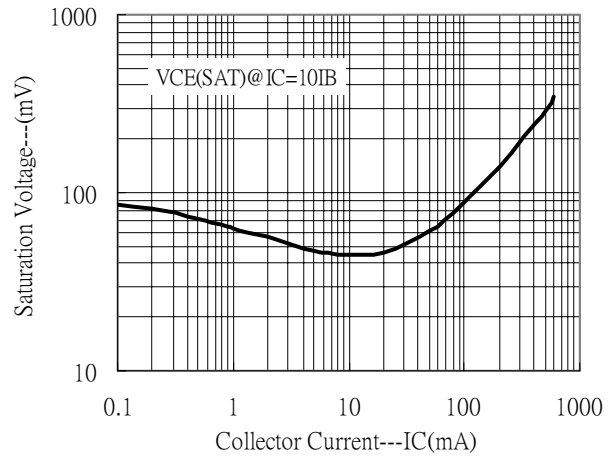

Saturation Voltage vs Collector Current

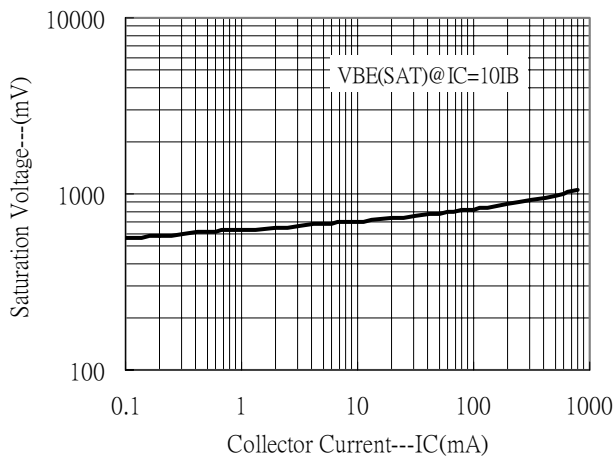

Cutoff Frequency vs Collector Current

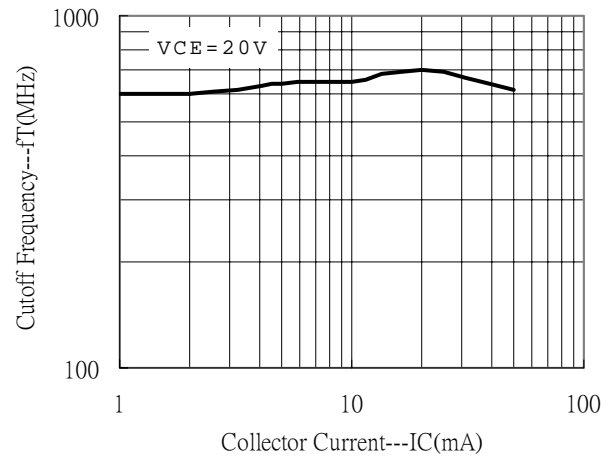

Power Derating Curves

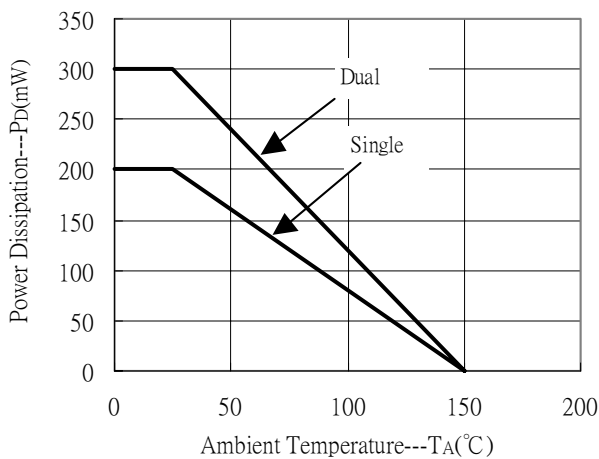

SOT-363R Dimension

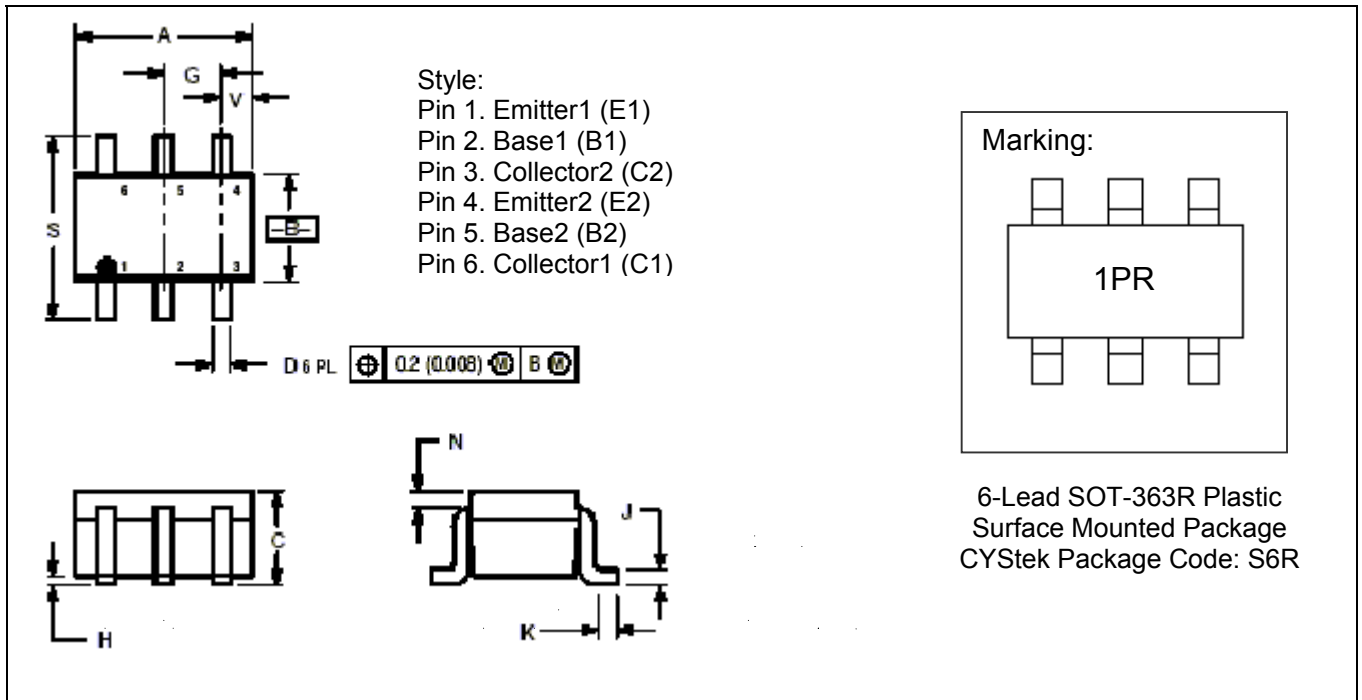

*:Typical

DIM	Inches		Millimeters		DIM	Inches		Millimeters	
	Min.	Max.	Min.	Max.		Min.	Max.	Min.	Max.
A	0.071	0.087	1.8	2.2	J	0.004	0.010	0.1	0.25
B	0.045	0.053	1.15	1.35	K	0.004	0.012	0.1	0.30
C	0.031	0.043	0.8	1.1	N	0.008 REF		0.20 REF	
D	0.004	0.012	0.1	0.3	S	0.079	0.087	2.00	2.40
G	0.026BSC		0.65BSC		Y	0.012	0.016	0.30	0.40
H	-	0.004	-	0.1					

Notes : 1.Controlling dimension : millimeters.
 2.Maximum lead thickness includes lead finish thickness, and minimum lead thickness is the minimum thickness of base material.
 3.If there is any question with packing specification or packing method, please contact your local CYStek sales office.

Material :

- Lead : 42 Alloy ; solder plating
- Mold Compound : Epoxy resin family, flammability solid burning class:UL94V-0

Important Notice:

- All rights are reserved. Reproduction in whole or in part is prohibited without the prior written approval of CYStek.
- CYStek reserves the right to make changes to its products without notice.
- CYStek **semiconductor products are not warranted to be suitable for use in Life-Support Applications, or systems.**
- CYStek assumes no liability for any consequence of customer product design, infringement of patents, or application assistance.